

# Earthquake-resistant Design for Architects

Revised edition



A free report with internet download  
<http://www.jaso.jp/>



Edited by  
the Japan Institute of Architects and  
Japan Aseismic Safety Organization

# Earthquake-resistant Building Design for Architects

Revised edition

Edited by the Japan Institute of Architects and Japan Aseismic Safety Organization

Shokokusha



## Foreword

### Katsumi Yano

Former-head of Japan Aseismic Safety Organization

### Earthquake resistance for users

I was greatly shocked after reading the damage report of the Great East Japan Earthquake published by the Condominium Management Companies Association for six prefectures of Tohoku. After surveying 1,642 condominiums they found “no severely damaged building” according to the Architectural Institute of Japan’s evaluation criteria for post-earthquake damage. In contrast, they found “100 demolished buildings” according to the victim’s certificate issued under the Act Concerning Support for Reconstructing Livelihood of Disaster Victims. This difference arises from two different viewpoints, an engineering assessment made of the degree of damage to a building, or an assessment made from the user’s perspective.

It is known that high-rise buildings raise a population density high, and upper floors are subject to extreme shaking, making them in need of comprehensive countermeasures. Although the fire damage suffered in large densely-populated cities like Tokyo tends to be greater, in terms of fire protection the building industry has depended solely on meeting laws and regulations.

When considering the points to be improved, based on these facts, structural engineers should calculate velocity response values (not only acceleration and displacement) and check that they are appropriate. Facilities engineers should ensure functions while securing various service flows between life lines and buildings. In the case of exterior major facilities, when the building has piles, pile foundations should be adopted. Moreover, I would think that, in many cases, the assumptions of relative displacement between buildings and the ground have been insufficient.

Regarding the earthquake resistance of finishing materials, I hope architects decide countermeasures based on in-depth discussions with structural engineers. Both modern architecture and users are much diversified. There is a great difference between the aged and the young in their response capacity to an earthquake and in their ability to escape. Therefore, architects should consider both lower and upper floors, ground areas liable to quake, urban areas with high fire risk, and so on. Otherwise they will not be trusted by society.

Doctors provide both the diagnosis and prescribe the remedy. I hope architects, do not hide from earthquakes behind laws and regulations, but rather become an excellent architect in the same way as an excellent doctor. I hope structural engineers and facilities engineers also do not shelter behind current earthquake laws and standards, but rather find partners who do their best while worrying and struggling with each individual decision concerning such areas as design, cost, structure, etc.

Although there have been many earthquake resistance textbooks for structural engineers, there are few books like this textbook which takes a comprehensive view of architecture from many individual perspectives including design, facilities, and construction. I offer my congratulations on the publishing of this extraordinary book as a concrete realization of the passion and enthusiasm of the coauthors.

### Editorial Committee of

#### “Earthquake-resistant Building Design for Architects: Revised edition”

#### Committee members

Mitsugu Asano, Kazuo Adachi, Toshio Okoshi, Shoeki Kurakawa, Wataru Kuroda, Junichi Nakata, Masahiro Hirayama, Yoshikazu Fukasawa

#### List of coauthors

Mitsugu Asano (Nikken Housing System Ltd.)  
Kazuo Adachi (Nihon Sekkei, Inc.)  
Kazuhiro Abe (AB Jusekkei Registered Architects Office)  
Yoshifumi Abe (Nihon Sekkei, Inc.)  
Shinichi Ara (Orimoto Structural Engineers)  
Masatoshi Iida (Orimoto Structural Engineers)  
Hiroshi Ida (Nihon Sekkei, Inc.)  
Hiroshi Inao  
Hiroshi Inoue (Inoue Hiroshi Architects Office)  
Takeshi Umeno (Kume Sekkei Co., Ltd.)  
Toshio Okoshi (Tokyo Soil Research Co., Ltd.)  
Yukio Osawa (FMC)  
Hiromasa Katsuragi (Nihon Sekkei, Inc.)  
Mika Kaneko (Shimizu Corporation)  
Mamoru Kikuchi (Archetype Architects Office)  
Takahiro Kishizaki (Nichiou Architecture Inc.)  
Shoeki Kurakawa (Kurakawa Planning)  
Wataru Kuroda (Nihon Sekkei, Inc.)  
Susumu Kono (Kono Susumu & Architects)  
Sadako Koriyama (Kohriyama Architect & Associates)  
Jo Koshi (Nihon Sekkei, Inc.)  
Yoshio Shimada (Shimada Architect Studio)  
Tsunehide Takagi (InterSection Inc.)  
Tetsuo Tabei (Tokyo Soil Research Co., Ltd.)  
Taiki Tomatsu (Nihon Sekkei, Inc.)  
Junichi Nakata (Mayekawa Associates, Architects & Engineers)  
Hiroo Nanjo (Atelier Nanjo Inc.)  
Hanji Hattori (KR Kenchiku Kenkyujo)  
Masahiro Hirayama (Kankyo Systech)  
Yoshikazu Fukasawa (Mitsubishi Jisho Sekkei Inc.)  
Hiroyoshi Hasegawa (Nihon Sekkei MedicalCore, Inc.)  
Takashi Hirai (formerly of Nikken Sekkei Ltd.)  
Tetsu Miki (Kyodosekkei, Satsukisha Registered Architects Office)  
Narifumi Muraio (Architect)  
Shigeo Morioka (Alphi-Design)  
Akiko Yamaguchi (Orimoto Structural Engineers)  
Kazuhiro Yamasaki (Orimoto Structural Engineers)  
Hirofumi Yoshikawa (Orimoto Structural Engineers)  
Takashi Yonemoto (Orimoto Structural Engineers)

#### Coordinators

Toshikazu Sato (Japan Aseismic Safety Organization)  
Shinya Tsutsui (The Japan Institute of Architects)  
Toru Nakata (Japan Aseismic Safety Organization)

#### Binding & text design

Tomoko Ihara (FEDL)

## Introduction

### Junichi Nakata

Chairperson of the board of directors, Japan Aseismic Safety Organization  
Former chairperson of the Anti-Disaster Measures Committee, the Japan Institute of Architects

This book is a newly-revised edition of “Earthquake-resistant Building Design for Architects” (Shokokusha, 1997). The first edition was compiled by the Japan Institute of Architects (JIA) and based upon a review of the damage and the effects of the Hyogoken-Nanbu Earthquake which occurred early on January 17, 1995; the purpose was to expand architects’ education on earthquake-resistant design.

The destruction in the Hanshin-Awaji area caused by the Hyogoken-Nanbu Earthquake, a giant earthquake hitting modern cities, was a traumatic incident for the architects and architectural engineers of that time. The Japan Institute of Architects recognized the importance of taking a comprehensive approach to designing architecture which could stand against earthquakes. The Institute worked in fields related to architecture including architectural structure, equipment and design, and held consecutive symposiums on earthquakes viewed from many different perspectives. It then compiled the findings of the symposiums into “Earthquake-resistant Building Design for Architects.”

The enormous destruction in East Japan caused by the Tohoku Earthquake (M9) on March 11, 2011 at 14:46 were due to the consecutive breaking of the faults in the area off-the Pacific coast ranging 500 km in a north-south direction and 200 km in an east-west direction; this area had never been the focus of any great earthquake predictions. The great earthquake with a seismic intensity of 7, was followed by tsunamis hitting the many towns and villages which had expanded with the development of post-war Japan. Even in the metropolitan area of Tokyo, a seismic intensity of 5 was measured. The earthquake caused unprecedentedly high damage including 15,854 deaths, 3,155 people missing and 343,935 refugees (as of March 11, 2012). Damaged areas were spread over a wide region from mountainous and coastal lands to the plains, and from rural areas to urban areas.

Furthermore, ground liquefaction occurred in an area wider than that had been assumed. In urban central areas, skyscrapers suffered damage from long-period seismic motions. Building damage included non-structural building elements. These non-structural elements that constitute modern buildings have increasingly been manufactured in factories and homogenized along with the economic growth and the modernization of building production, and it had been assumed that their seismic capacities were ensured in terms of construction methods. However, many of them suffered considerable damage.

The towns and buildings which had been modernized with the development of post-war Japan and had become today’s living environment were hit by the earthquake. General issues of living in condominiums immediately drew attention, and the issues of the shape and future of community as well as the aging of society were highlighted, not only in the areas close to the focus but also in the distant metropolitan areas. Infrastructure was damaged, many commuters were unable to return home,

electrified functions stopped, and the daily lives of many people were greatly affected.

For the revised edition, based on experiences from the first edition of 1997 through to the Great East Japan Earthquake, the issues recently revealed were reviewed including structure, the effects of tsunamis that had previously been put to the side and regarded as not related to buildings, but nevertheless caused great damage to buildings in the Great East Japan Earthquake, and liquefaction that caused considerable damage in the Tokyo metropolitan area, as well as the long-period seismic motion of skyscrapers. The revised edition has been fully rewritten with additional content including community fire prevention plans, new concepts for community development, and business continuity plans (BCP), as well as preparing for a direct earthquake hit in the Tokyo area. In addition, the content on the issue of infrastructure and energy as well as the latest findings on communication functions at the time of the disaster have been added, and the content on the issue of seismic capacity regarding architectural equipment has been supplemented.

Present day Japan is in a period of regular seismic activity, and earthquakes with a seismic intensity of 3 or greater are observed several times a day. It is common knowledge a direct hit by an earthquake on the Tokyo area could occur at any time, and countermeasures against such earthquakes are being strengthened. In regard to western Japan, measures are being considered assuming earthquakes in Tokai, Tonankai, and Nankai. By adding new authors for the purpose of contributing to building a social environment with great seismic capacity, the Japan Institute of Architects and Japan Aseismic Safety Organization have published a newly-revised edition of “Earthquake-resistant Building Design for Architects.” The book makes available the latest research and contents to the general public and to the many architectural experts including architects, structural and facilities engineers who engage in the improvement of people’s living environment.

I hope that readers make a step toward building a safer and more secure living environment.

## Introduction to the first edition

### Takekuni Ikeda

Chairperson of the JIA Urban Disaster Committee,  
the Japan Institute of Architects (at the time of the first edition in 1997)

A great earthquake hit the Hanshin-Awaji area on January 17, 1995, at 5:46 and the most severely affected area was concentrated in a band from 1 to 2 km wide, 20 to 30 km long and running along the coastline and the active faults that played a big part in the formation of the Rokko Mountains and Awaji Island. Since most of the belt-shaped area consists of highly-populated urban areas, the earthquake caused more than 6,300 deaths, and estimates calculate the total amount of physical damage to exceed 10 trillion yen.

To protect and nurture people's lives is primarily the ultimate mission of architecture and the purpose of a city, and those people whose vocation is to achieve the mission's goal are architects. Despite such concepts, at the time of this earthquake, the city and its building architecture destroyed people's living environment and turned into a dangerous weapon which took many lives in just a few moments. It is the task of architects to face and respond to this grave reality.

It is essential for architects and engineers to analyze and incorporate the invaluable knowledge gained from the earthquake at the cost of the suffering of more than 300 thousand people and the loss of many precious lives.

Soon after the earthquake, the JIA Urban Disaster Committee of the Japan Institute of Architects deployed their best efforts to learn as many lessons from this destructive but natural event to discover what architecture and a city of the future ought to be, and signpost the way to the 21st century.

During its investigations, the Committee announced to the public its urgent "recommendations" on the issues. In October 1995, it held a conference on the Hanshin-Awaji Earthquake, and documented the content in a 191 page book. Around the same time, it held seminars on seismic retrofit for both architects and clients, and documented the content in a 160 page Q & A text. However, through rereading the records and the reports of earthquakes in recent decades, including the Great Kanto Earthquake of 1923, it was found that a considerable part of what were thought to be new facts revealed for the first time had been already reported before. Although there had been previous records and reports, they were only read by a limited number of people such as experts in the areas of earthquake and earthquake-resistant construction. We architects, who engage in the design and planning of architecture and cities, were urged to re-examine ourselves concerning our indifference to these earlier records and reports.

In the aftermath of the Great Hanshin-Awaji Earthquake, we found that our valuable past experience had not been effectively incorporated in the design and planning of architecture and cities. Architects, who bear a social responsibility as experts in these areas, have to keep such a fact firmly in mind. Looking back at the earthquake this time which produced many victims and refugees, architects are not allowed to repeat the same mistakes as previously. The JIA Urban Disaster Committee also came

to the conclusion that the compilation of the Great Hanshin-Awaji Earthquake's summary report did not mean the accomplishment of its role.

The Committee realized in order to utilize the precious lessons from the earthquake learned through the Committee's activities undertaken for over a year since the earthquake, it should compile them, from an architect's perspective, in an earthquake-resistant building design textbook for architects, and provide it as a reference to each JIA member.

This textbook is a first attempt not only in the history of JIA but also in that of architectural education in Japan. In addition, it was compiled in a very short period, and therefore, it is not perfect. Moreover, there are still many unknown aspects concerning earthquakes as natural phenomenon, and there are many issues in various fields which will have to wait for the results of future study. Japan is one of a few countries in the world that experiences frequent earthquakes, and there is no doubt that this textbook contains extensive content on precious issues that architects in Japan must study, understand and apply.

The Committee will continually revise the textbook and overtime expand it into a more extensive edition, in the hope that it will contribute to further our knowledge of earthquake-resistant design and architecture.

## Architects and earthquake-resistant design

### Narifumi Murao

Former president, the Japan Institute of Architects  
Former secretary of the JIA Urban Disaster Committee,  
the Japan Institute of Architects

A half century has already passed since the Second World War ended. During this time, Japan has risen from out of the ashes and achieved a miraculous recovery and extraordinary economic growth. It is well known that the building industry of Japan also contributed to and benefited from the prosperity of these times. Since the last decade of the 20th century, however, Japan has again faced radical changes. During the period, the international environment greatly changed, as seen by the end of the Cold War between the East and the West, and the economic rise of East Asia. The collapse of the bubble economy that characterized the 1980s in Japan and the following qualitative change in social, political, and economic structures all occurred in the same period. Moreover, global environmental problems became increasingly obvious, and triggered by the Great Hanshin-Awaji Earthquake and the Great East Japan Earthquake the need to basically review the role of building technology became increasingly important. Furthermore, the institutional fatigue of various systems which had supported economic growth for 60 years has attracted attention as an important issue. It seems that we have reached a turning point where we should humbly reconsider those concepts which we have taken for granted across many fields. Regarding architecture and architects, it has become necessary to carry out a basic review of the way architectural spaces should function. In other words, architects are held socially responsible for creating cities and architecture where people can live safely and securely.

Although there is a wide design field where an architect can carry out earthquake-resistant design alone, such as wooden houses and the like, most of today's sophisticated modern buildings are designed through team work involving various experts and with the leading role played by an architect. This is natural in order to incorporate the results of rapid technical progress and ensure the comprehensive quality of buildings as a distillation of many different disciplines. The creative activity of architecture through a team, works by members respecting each other's expertise and communicating and accumulating know-how among team members. Essential to the flow of such team work is the contact point with the client, the contact point is a person in charge of overseeing the whole team, suggesting and deciding the basic concepts of architectural spaces, fleshing out the details of everyday usability, developing the details for visual and spatial design and materialization, selecting a contractor and building a framework for construction phases, ensuring that construction is implemented in accordance with the design, and working on community development as appropriate. The person who fulfills this wide brief of skills is called an architect.

The architect's role to oversee the whole project, standing in the midst of many fields, is very important from a viewpoint of the comprehensiveness of architecture as an aggregate of a variety of many different kinds of expertise. An architect is

required to have awareness, judgment, and energy as the person responsible for the whole of the project architecture in such a way that they should see the issues in a variety of fields as they relate to the whole picture, and not just to each individual field. When an architectural defect occurs due to a loss of totality in the design team, the architect is primarily responsible for such an error, followed by the other experts who also bear responsibility. Anyone who believes that an architect is responsible for only narrowly-defined design work is not able to fulfill the social responsibility of an architect, and may be called a designer, but never an architect. Among the team, the earthquake-resistant design of structural frames is within the structural engineer's remit, and not within the architect's field. It is natural that a structural engineer plays an important role in improving the seismic capacity of buildings. However, seismic capacity of structural frames depends on the basic concepts of architectural spaces for which the architect plays the leading role. Moreover, earthquake-resistant design of structural frames alone does not ensure the safety of the living environment as a whole. An architect must oversee the whole team, and suggest and decide the basic concepts of architectural spaces, with sufficient understanding of both the way the safety of the living environment as a whole ought to be, and the present state and basic concepts of earthquake-resistant technology.

The Great Hanshin-Awaji Earthquake and Great East Japan Earthquake taught us that there are very many fields which should be considered other than earthquake-resistant technology itself when we think about architecture from a comprehensive perspective relating to the living environment as a whole. Particularly, these earthquakes made us realize the importance of active involvement in community development including the way densely populated districts of wooden buildings ought to be planned. In other words, they made us keenly feel that architects are expected to widely play an important role in the creation of the living environment across architecture and community as an aggregate of a district's buildings.

Earthquake-resistant technology is fated to be particular about certain hard aspects, and that is why the actual everyday life of people, the bettering of which is architecture's intended purpose, is apt to be forgotten. For example, we usually forget the fact that people's daily life continues even after an earthquake. It is thus strongly claimed that the function of cities, in addition to the quality of human life, should be emphasized. It is also clear that architecture and cities are more comprehensive when they are viewed from the perspective of people's lives. Considering only earthquake resistance of buildings is insufficient.

Architecture or cities are not created for safety alone; they are created to satisfy everyday functions and to provide a desired living environment. An architect is required to comprehensively create a space for these functions and environment as well as safety. An architect must consider earthquake resistance from such a compre-

hensive perspective.

In Japan, a country with frequent earthquakes, earthquake resistant technology is one of the specific areas of expertise of architecture that has been studied most deeply. It may be true that it is close to impossible for an architect, who is not an expert in earthquake resistant technology, to argue it in detail. However, the fact that the law defines nothing more than minimum standards for earthquake resistance is apt to be forgotten. Moreover, every time a great earthquake, tsunami, liquefaction, or malfunction of generating equipment occurs, even these legal standards have been amended. As such, there are a lot of unknown points about earthquake hazards. Under these circumstances, it is apparent that an architect, who has a social mission to protect people's lives and to create a life-enhancing environment, should not limit themselves to simply following the minimum standards. An architect is required to explain earthquake resistance in lay terms and engage in persuasive dialogue with their client. Moreover, an architect stands at the connecting point between the building industry and society.

There is no doubt that sophisticated expertise characterizes modern civilization. However, being too much influenced by conceptions of specialization and technological progress, an architect may not have realized that such sophisticated expertise is an important part of the comprehensive responsibility of the role of an architect. This "Earthquake-resistant Building Design for Architects" has been compiled based on such reflections. The idea of this textbook is a handing-on of wisdom from senior to mid-career architects. This textbook is also supported by an idea that architects themselves could write a more appropriate textbook for architects than experts of structural technology.

Based on these ideas, this textbook has been compiled with members of the Japan Institute of Architects and Japan Aseismic Safety Organization playing a leading role. I hope that many people including architects read it, utilize it, and criticize it.

Finally in the devastation suffered after the Great Hanshin-Awaji Earthquake and the Great East Japan Earthquake, being involved in the construction industry, we felt really helpless in the face of such destruction, and with this feeling as our starting point, we have addressed many activities and the completion of this textbook encourages us to feel we have made some progress along the road to creating a safer living environment.

## Architects and earthquake-resistant design

### Narifumi Murao

Former president, the Japan Institute of Architects  
Former secretary of the JIA Urban Disaster Committee, the Japan Institute of Architects

A half century has already passed since the Second World War ended. During this time, Japan has risen from out of the ashes and achieved a miraculous recovery and extraordinary economic growth. It is well known that the building industry of Japan also contributed to and benefited from the prosperity of these times. Since the last decade of the 20th century, however, Japan has again faced radical changes. During the period, the international environment greatly changed, as seen by the end of the Cold War between the East and the West, and the economic rise of East Asia. The collapse of the bubble economy that characterized the 1980s in Japan and the following qualitative change in social, political, and economic structures all occurred in the same period. Moreover, global environmental problems became increasingly obvious, and triggered by the Great Hanshin-Awaji Earthquake and the Great East Japan Earthquake the need to basically review the role of building technology became increasingly important. Furthermore, the institutional fatigue of various systems which had supported economic growth for 60 years has attracted attention as an important issue. It seems that we have reached a turning point where we should humbly reconsider those concepts which we have taken for granted across many fields. Regarding architecture and architects, it has become necessary to carry out a basic review of the way architectural spaces should function. In other words, architects are held socially responsible for creating cities and architecture where people can live safely and securely.

Although there is a wide design field where an architect can carry out earthquake-resistant design alone, such as wooden houses and the like, most of today's sophisticated modern buildings are designed through team work involving various experts and with the leading role played by an architect. This is natural in order to incorporate the results of rapid technical progress and ensure the comprehensive quality of buildings as a distillation of many different disciplines. The creative activity of architecture through a team, works by members respecting each other's expertise and communicating and accumulating know-how among team members. Essential to the flow of such team work is the contact point with the client, the contact point is a person in charge of overseeing the whole team, suggesting and deciding the basic concepts of architectural spaces, fleshing out the details of everyday usability, developing the details for visual and spatial design and materialization, selecting a contractor and building a framework for construction phases, ensuring that construction is implemented in accordance with the design, and working on community development as appropriate. The person who fulfills this wide brief of skills is called an architect.

The architect's role to oversee the whole project, standing in the midst of many fields, is very important from a viewpoint of the comprehensiveness of architecture as an aggregate of a variety of many different kinds of expertise. An architect is

required to have awareness, judgment, and energy as the person responsible for the whole of the project architecture in such a way that they should see the issues in a variety of fields as they relate to the whole picture, and not just to each individual field. When an architectural defect occurs due to a loss of totality in the design team, the architect is primarily responsible for such an error, followed by the other experts who also bear responsibility. Anyone who believes that an architect is responsible for only narrowly-defined design work is not able to fulfill the social responsibility of an architect, and may be called a designer, but never an architect. Among the team, the earthquake-resistant design of structural frames is within the structural engineer's remit, and not within the architect's field. It is natural that a structural engineer plays an important role in improving the seismic capacity of buildings. However, seismic capacity of structural frames depends on the basic concepts of architectural spaces for which the architect plays the leading role. Moreover, earthquake-resistant design of structural frames alone does not ensure the safety of the living environment as a whole. An architect must oversee the whole team, and suggest and decide the basic concepts of architectural spaces, with sufficient understanding of both the way the safety of the living environment as a whole ought to be, and the present state and basic concepts of earthquake-resistant technology.

The Great Hanshin-Awaji Earthquake and Great East Japan Earthquake taught us that there are very many fields which should be considered other than earthquake-resistant technology itself when we think about architecture from a comprehensive perspective relating to the living environment as a whole. Particularly, these earthquakes made us realize the importance of active involvement in community development including the way densely populated districts of wooden buildings ought to be planned. In other words, they made us keenly feel that architects are expected to widely play an important role in the creation of the living environment across architecture and community as an aggregate of a district's buildings.

Earthquake-resistant technology is fated to be particular about certain hard aspects, and that is why the actual everyday life of people, the bettering of which is architecture's intended purpose, is apt to be forgotten. For example, we usually forget the fact that people's daily life continues even after an earthquake. It is thus strongly claimed that the function of cities, in addition to the quality of human life, should be emphasized. It is also clear that architecture and cities are more comprehensive when they are viewed from the perspective of people's lives. Considering only earthquake resistance of buildings is insufficient.

Architecture or cities are not created for safety alone; they are created to satisfy everyday functions and to provide a desired living environment. An architect is required to comprehensively create a space for these functions and environment as well as safety. An architect must consider earthquake resistance from such a compre-

hensive perspective.

In Japan, a country with frequent earthquakes, earthquake resistant technology is one of the specific areas of expertise of architecture that has been studied most deeply. It may be true that it is close to impossible for an architect, who is not an expert in earthquake resistant technology, to argue it in detail. However, the fact that the law defines nothing more than minimum standards for earthquake resistance is apt to be forgotten. Moreover, every time a great earthquake, tsunami, liquefaction, or malfunction of generating equipment occurs, even these legal standards have been amended. As such, there are a lot of unknown points about earthquake hazards. Under these circumstances, it is apparent that an architect, who has a social mission to protect people's lives and to create a life-enhancing environment, should not limit themselves to simply following the minimum standards. An architect is required to explain earthquake resistance in lay terms and engage in persuasive dialogue with their client. Moreover, an architect stands at the connecting point between the building industry and society.

There is no doubt that sophisticated expertise characterizes modern civilization. However, being too much influenced by conceptions of specialization and technological progress, an architect may not have realized that such sophisticated expertise is an important part of the comprehensive responsibility of the role of an architect. This "Earthquake-resistant Building Design for Architects" has been compiled based on such reflections. The idea of this textbook is a handing-on of wisdom from senior to mid-career architects. This textbook is also supported by an idea that architects themselves could write a more appropriate textbook for architects than experts of structural technology.

Based on these ideas, this textbook has been compiled with members of the Japan Institute of Architects and Japan Aseismic Safety Organization playing a leading role. I hope that many people including architects read it, utilize it, and criticize it.

Finally in the devastation suffered after the Great Hanshin-Awaji Earthquake and the Great East Japan Earthquake, being involved in the construction industry, we felt really helpless in the face of such destruction, and with this feeling as our starting point, we have addressed many activities and the completion of this textbook encourages us to feel we have made some progress along the road to creating a safer living environment.



# Table of Contents

建築家のための耐震設計教本 改訂版

Earthquake-resistant Building Design for Architects Revised edition

## 1 Earthquakes and Earthquake Disasters

- 16 1-1 Earthquakes and earthquake disasters
- 18 1-2 Oceanic and terrestrial earthquakes
- 20 1-3 Hyogoken-Nanbu Earthquake
- 22 1-4 2011 Tohoku Earthquake
- 24 1-5 Earthquakes and tsunamis in history
- 26 1-6 Earthquake and seismic motion

## 2 Difference in Seismic Performance Depending on the Ground

- 28 2-1 Points to note concerning the ground
- 30 2-2 Quake behaviors vary depending on the characteristics of the ground
- 32 2-3 Sites prone to liquefaction
- 34 2-4 Countermeasures against liquefaction
- 36 2-5 Seismic ground failure of developed land
- 38 2-6 Addition to seismic force in structural calculations
- 40 2-7 Soil investigation as the basis of design

## 3 Damage from Tsunami

- 42 3-1 Cause and type of tsunami
- 44 3-2 Force of tsunami
- 46 3-3 Tsunami hazard map
- 48 3-4 Towns that withstood the tsunami
- 50 3-5 Buildings that withstood the tsunami

## 4 Required Performance Based Design

- 52 4-1 Formative design and everyday function vs. disaster prevention/earthquake resistant performance
- 54 4-2 Transition of seismic design method
- 56 4-3 Earthquake-resistant design methods abroad
- 58 4-4 Amendment of the law after the Great Hanshin-Awaji Earthquake
- 60 4-5 Earthquake resistant performance and structural frame costs

## 5 Different Earthquake Resistance Performance Depending on the Building

- 62 5-1 Buildings that protect human lives and functions
- 64 5-2 Securing functions and business continuity
- 66 5-3 Public requirement and client requirement
- 68 5-4 Importance level of a building
- 70 5-5 Ensuring consistency among the earthquake resistance performance of building

### Issues by building use

- 72 (1) Apartment buildings
- 73 (2) Super-high-rise apartment building
- 74 (3) Schools
- 75 (4) Museums and libraries
- 76 (5) Hospitals
- 78 (6) Halls, meeting places, and gymnasiums
- 79 (7) City hall
- 80 (8) Local disaster control centers
- 81 (9) Hotels
- 82 (10) Location of a disaster refuge

## 6 Diversification of Structural Systems and Choice

- 84 6-1 Planning earthquake resistant construction
- 86 6-2 Planning seismically isolated structures
- 88 6-3 Aiming for response controlled structures
- 90 6-4 Aseismic planning of high-rise buildings

## 7 Building Shape and Earthquake Resistant Performance

- 92 7-1 Well-balanced buildings and earthquake resistant performance
- 94 7-2 Buildings with good planar balance
- 96 7-3 A story with low rigidity in any part of a building should be avoided
- 98 7-4 Benefits of expansion joints and points to note
- 100 7-5 Benefits of basements and points to note
- 102 7-6 Other points to note

## 8 Earthquake-resistant Design of Non-structural Building Elements

- 104 8-1 Expanding the earthquake-resistant design from the building frame to non-structural building elements
- 106 8-2 Prevention of falling glass. e.g. windows, partitions, etc.
- 108 8-3 Design and performance of curtain walls
- 110 8-4 Earthquake-resistant design of ALC and paneled exterior walls
- 112 8-5 Prevention of ceiling collapse
- 114 8-6 Earthquake-resistant design of interior walls and interior finishes
- 116 8-7 Fixing and layout of furniture and fixtures

## 9 Earthquake-resistant Design of Equipment

- 118 9-1 Points of earthquake-resistant design of equipment
- 120 9-2 Earthquake damage examples and building elements and equipment prone to damage
- 122 9-3 Securing equipment functions after an earthquake
- 124 9-4 Points of equipment planning for seismically isolated buildings
- 126 9-5 Seismic countermeasures for elevators (1)
- 128 9-6 Seismic countermeasures for elevators (2)

## 10 Earthquake-resistant Design of Equipment

- 130 10-1 Earthquake-resistant design and construction methods of wooden houses
- 132 10-2 Seismic retrofit of wooden houses
- 134 10-3 Residential environments and disaster prevention in densely crowded areas of wooden buildings

## 11 Supervision of Construction and Follow-up after Completion

- 136 11-1 Quality of construction makes a difference in earthquake resistance performance
- 138 11-2 Points for the selection of a contractor
- 140 11-3 Supervision of architecture, structure and utilities works
- 142 11-4 Performance assurance at completion and information management
- 144 11-5 Maintenance and renewal
- 146 11-6 Seismic diagnosis of existing buildings
- 148 11-7 Seismic strengthening of existing buildings
- 150 11-8 Architect's role in disasters
- 152 11-9 Earthquake insurance and architect's liability policy

## 12 Cooperation with Structural Engineers and Facility Engineers

- 154 12-1 Leadership of the architect and teamwork
- 156 12-2 Architects, structural engineers and facility engineers
- 158 12-3 Role of structural engineers and facility engineers

## 13 Limitations of Urban Facilities and Self-sustaining Disaster Prevention Schemes

- 160 13-1 Limitations of urban infrastructure
- 162 13-2 Infrastructure improvement ensuring compatibility between disaster prevention and the environment
- 164 13-3 Ensuring self-sustaining functions
- 166 13-4 Limitations and utilization of information infrastructures

## 14 Community Development and Earthquake Disaster Countermeasures

- 168 14-1 Buildings and community as social wealth
- 170 14-2 Integrating disaster prevention functions into a community
- 172 14-3 Regional planning prepared against fire
- 174 14-4 Disaster prevention function of exterior space
- 176 14-5 Earthquake resistance of civil engineering structures and other structures
- 178 14-6 Philosophy of reconstruction plans

## 15 The Living Environment and Earthquake Disaster Countermeasures of the Future

- 180 15-1 Lifestyle and disaster
- 182 15-2 An advanced information society and disaster countermeasures
- 184 15-3 An aging society and disaster countermeasures

- 186 Appndix
- 184 Postscript

### About the indexes

These indexes are classified for referencing according to architectural phases in chronological order. Readers can carry on reading in chronological order as well as use them depending on their interest and by searching the necessary phase and content.

- Survey: the content of matters studied before planning
- Planning: the content of matters concerning the preliminary phases toward design
- Design: the content of design
- Construction: the content of construction
- Maintenance: the content of matters necessary after the completion of a building
- Other: the content including mechanisms of earthquakes, reports on disaster surveys, sophisticated expertise, cross-industry and public administration, and cooperation with members of the public

# 1 Earthquakes and Earthquake Disasters

## 1-1 Earthquakes and earthquake disasters

Earthquakes are a natural part of our planet's activities and have come to be understood by the study of plate tectonics. Earthquakes fall under several classifications according to their generating mechanism such as terrestrial, oceanic, volcanic, etc. Earthquakes cause enormous disruptions such as crustal deformations, slope failures, liquefactions, earthquake damages, fires, tsunamis, and fires caused by tsunami.

### Plate tectonics

The mechanisms involving the land masses of the entire Earth only began to be understood 50 to 60 years ago after analyzing data from seafloor bores obtained by the United States Navy during the Second World War. Analysis showed that even the oldest stratum is 200 to 300 million years old and does not match the age of the Earth, some 4.6 billion years. In addition it was found that the seafloor is constantly moving at a speed of 2 to 3 cm a year. It seems that the power sources of this movement are submarine ridge areas, and the seafloor drops down to a trench area. This theory advocates that the Earth's crust, a thin layer like an eggshell at the ground surface with a thickness of only 2 to 3 km, moves horizontally very slowly driven by the thermal convection of the underlying mantle layer. This theory is known as plate tectonics, and is a research area that advanced rapidly after the war, and reached some degree of comprehension in the 1960s. With this theory, the theory of continental drift put forward by Wegener was established in 1912, and also offered explanations for the height of the Himalayan Mountains or the depth of the Japan Trench and Philippine Trench (Figure 1). (Hanji Hattori)

### Plate structure of Japan

The Japan islands are separated at the Fossa Magna (Figure 2, Figure 3) into the northeast of Japan which is on the North American Plate and the southwest of Japan which is on the Eurasian Plate. There is also the Itoigawa-Shizuoka Tectonic Line at the western edge of the Fossa Magna, and the Kashiwazaki-Chiba Tectonic Line at the eastern edge.

The Pacific Plate, which is heavy, moves west from northeast Japan, and slides under the North American Plate, thus forming the Japan Trench. The Philippine Sea Plate moves northwest from southwest Japan, and pushes under the Eurasian Plate, thus forming the Suruga Trough and Nankai Trough.

At the south of Sagami Bay, the Philippine Sea Plate slides under the North American Plate, forming the Sagami Trough. The Pacific Plate goes under the Philippine Sea Plate at the Izu-Ogasawara Trench, forming the Shichito-Iwojima ridge at the eastern edge of the Philippine Sea Plate. The Izu Peninsula, which used to be a part of this ridge, moved north and as it could not go under directly with the Eurasian Plate, and pushed up the Fossa Magna, which used to be a sea leading to the Sea of Japan.

### Earthquakes of Japan

The Japan islands are located on these four plates, and are continuously moving due to plate activity. In the land area, there are a myriad of cracks called faults, where frictional force is holding the transformation of the land. When the frictional force reaches a limit, the land suddenly slides and with the

release of strain energy, an earthquake occurs. This is called a terrestrial earthquake.

An oceanic plate bends where it slides under a terrestrial plate and an intraplate earthquake occurs at this point. At the interfacial boundaries there is an adhered section, and when the frictional stress reaches a limit the plate slides and an earthquake occurs at the plate boundary (Figure 4). This is called an oceanic earthquake. This sudden sliding and/or transformation generates further transformation, and intermittent aftershocks occur until the ground settles down again.

### Earthquakes and disasters

Disasters at the time of earthquakes include destruction caused by crustal deformation, by man-made structures, and by tsunami.

Disasters caused by crustal deformation include strike slip, subsidence, uplift of the ground, slope failure, debris flow, liquefaction, and lateral flow. These may occur simultaneously on developed land. Ground subsidence at a coastal area may cause the ground to drop below sea level. Disasters caused by man-made structures include collapse and serious damage caused by seismic motion, and any consequent fires. Buildings with insufficient earthquake resistance or fire resistance may result in many victims.

Death and destruction by tsunami includes drowning and the outflow of houses. They occur over limited areas, and the inundation height of the tsunami will effectively decide the outcome and extent of damage. Fires are caused by the floating-up and overturning of oil tanks, and the outflow and combustion of oil, and then spread to ships, cars, rubble, and mountain forest.

### Naming of earthquakes according to the scale of the disaster

The name of an earthquake is decided by the degree and the location of damage, regardless of the intensity or the focus of the earthquake. A giant earthquake occurring in a sparsely populated region and causing little damage will not receive the adjective great. On the other hand, even a small- to mid-scale earthquake occurring in a densely populated area with much damage to many houses with insufficient earthquake resistance will be known as a great earthquake.

The Genroku Earthquake and the Great Kanto Earthquake are two earthquakes of the Kanto area. The Sanriku region was hit by the 1896 Meiji-Sanriku Earthquake and the 1933 Showa-Sanriku Earthquake. All of these earthquakes are also known as tsunami earthquakes because of the extreme damage caused by the tsunamis following the quakes. The 1995 Hyogoken-Nanbu Earthquake is also known as the Great Hanshin-Awaji Earthquake, and the 2011 Tohoku Earthquake is also known as the Great East Japan Earthquake. (Toshio Okoshi)

□ Sources of figures

- 1) Kiyoo Mogi, Chikyū Monthly, No. 13, Kaiyō Shuppan, 1995
- 2) Based on the website of the Oshika Museum of Japan Median Tectonic Line <http://www.osk.janis.or.jp/~mtl-muse/subindex03.htm>
- 3) Website of the Headquarters for Earthquake Research Promotion, Seismic Activity in Japan - Regional perspectives on the characteristics of destructive earthquakes, 2009 (electronic publishing only) [http://www.jishin.go.jp/main/p\\_koho05.htm](http://www.jishin.go.jp/main/p_koho05.htm)

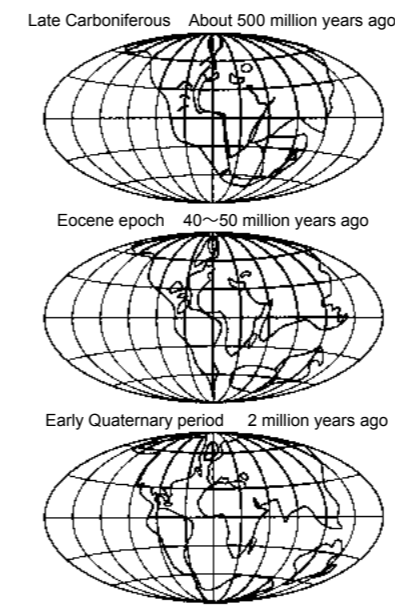

Figure 1. Observation diagram of continental mass transition by Wegener<sup>1)</sup>

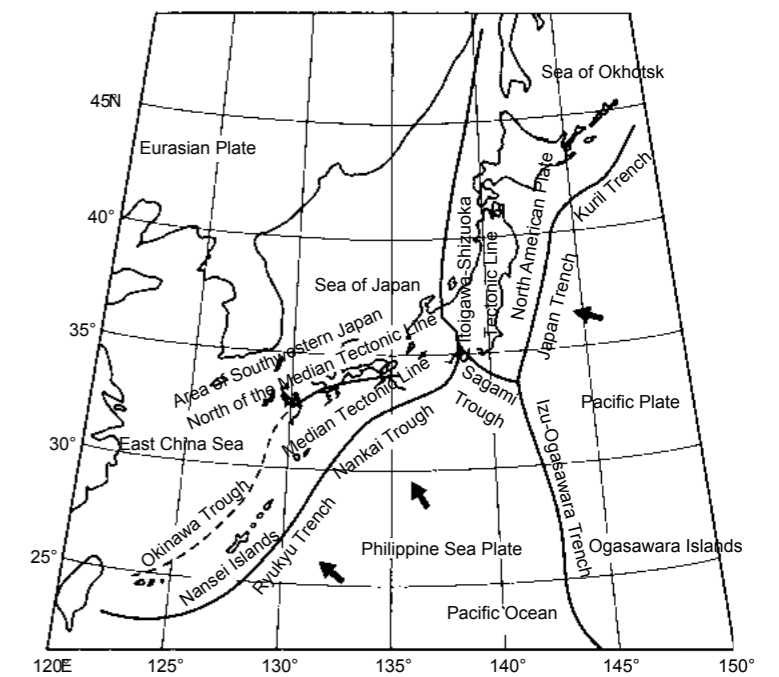

Figure 2. Boundaries and relative motions of the four plates around Japan islands<sup>2)</sup>

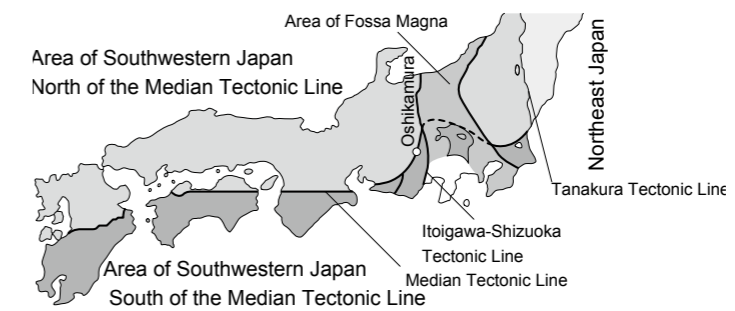

Figure 3. Median Graben and Median Tectonic Line<sup>2)</sup>

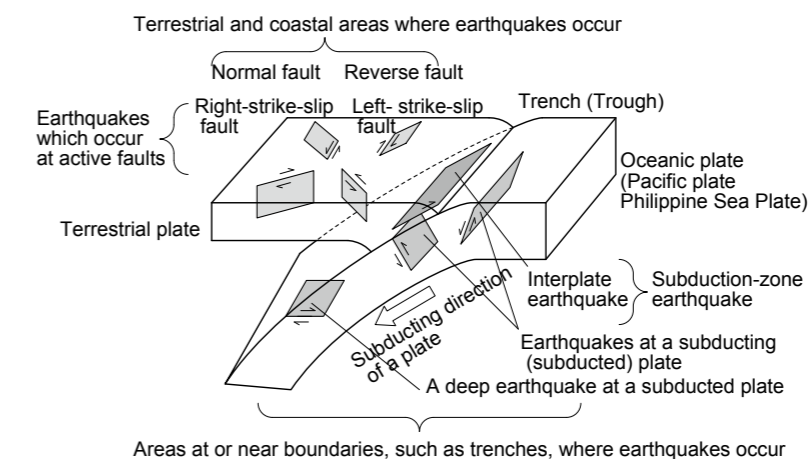

Figure 4. Types of earthquakes occurring in a subduction zone<sup>3)</sup>

## 1-2 Oceanic and terrestrial earthquakes

An oceanic plate bends as it goes under a terrestrial plate and earthquakes occur in the oceanic plate. Although an oceanic plate slides with a certain speed, interfacial boundaries adhere to each other, and at the moment when the frictional stress reaches its limit an earthquake occurs. A terrestrial plate is pressed and twisted, and generates faults, that cause earthquakes at the moment they slide.

### Plate activities and earthquakes

Northeast Japan has been pressed from both the east and west, and folded mountains have risen in a north-south direction. As part of this process, terrestrial earthquakes due to reverse faults (compression) have occurred. Southwest Japan has been pressed from north and west, and has been subject to shearing deformation in both east-west and north-south directions. The Median Tectonic Line has been formed in an east-west direction, and the Itoigawa-Shizuoka Tectonic Line and Noubi fault zone have been formed in a north-south direction, terrestrial earthquakes due to strike-slip faults have occurred. The Median Tectonic Line intersects with the Itoigawa-Shizuoka Tectonic Line at Lake Suwa (Figure 1).

In the Beppu-Shimabara Graben and Kagoshima Graben in Kyushu, a huge caldera has been formed, and terrestrial earthquakes due to normal faults (tension) have occurred.

### Terrestrial earthquakes of northeast Japan

The Pacific Plate is moving westward at about 10 cm a year, and is passing under the North American Plate. The interfacial boundary is sliding while forming a crushing belt, and is subject to frictional force. The North American Plate is dragged in and pressed at the interfacial boundary. Northeast Japan being pressed both eastward and westward has formed wrinkles (mountains) in the north-south direction, and shrunk. At the moment a crack (a reverse fault) occurs at any weak section and when it suddenly slides, an earthquake with about M7 occurs (Figure 2).

### Terrestrial earthquakes of southwest Japan

The Philippine Sea Plate is moving northwestward at about 3 cm a year, and is passing under the Eurasian Plate. As such the Eurasian Plate is pressed northwestward, and southwest Japan on this plate is pressed northwestward and is subject to deformation and twisting (shearing deformation), and strike-slip faults have occurred in the north-south direction (such as the Itoigawa-Shizuoka Tectonic Line) and in the east-west direction (such as the Median Tectonic Line). At the moment the fault suddenly slides, an earthquake with about M8 occurs (Figure 2).

### Oceanic earthquakes

Oceanic earthquakes include intraplate earthquakes and interplate earthquakes.

An oceanic plate is bent at the location where it goes under a terrestrial plate, and at the moment when strain stress reaches a limit, it slides and an intraplate earthquake occurs.

The surface of the oceanic plate has an adhered section (asperity) where it passes under the terrestrial plate, and at the moment when the frictional stress reaches a limit an interplate earthquake occurs. The focus of an interplate earthquake is called an assumed focal region, where earthquakes with about

M8 periodically occur, and usually followed by an earthquake with about M9.

The average depth of the ocean is about 4 km, and the depth of trenches are about 8 km. A trench of 6 km or less in depth is called a trough.

### Japan Trench

Figure 3 shows the assumed focal region of the Japan Trench.

The earthquakes which occur in the region have smaller seismic motions, but cause greater tsunami damage. They are known as tsunami earthquakes and include the Jogan-Sanriku Earthquake, 1896 Meiji-Sanriku Tsunami and 1933 Showa-Sanriku Tsunami.

### Sagami Troughs

The Northeastern edge of the Philippine Sea Plate is moving northwestward at about 3 cm a year, and pushes under the North American Plate which is moving southeastward, and formed the Sagami Trough. The Pacific Plate is moving northwestward at about 7 cm a year and slides under the Philippine Sea Plate to form the Izu-Ogasawara Trench. Around the Sagami Trough, four plates are related, as well as there being strike-slip faults, making this area famous as a frequent earthquake zone. This is the focal region of the 1703 Genroku Earthquake (M8.1, Nojimazaki), 1855 Ansei Edo Earthquake (M6.9), and 1923 Great Kanto Earthquake (M7.9, Sagami Bay).

### Nankai Trough

Figure 4 shows the assumed focal region of the Nankai Trough.

The 1605 Keicho-Nankaido Earthquake (M8.0) was a tsunami earthquake. The 1707 Hoei Earthquake (M8.4) was a Tokai-Tonankai-Nankai-linked earthquake, and the 1854 Ansei-Tokai Earthquake (M8.4, includes Nankai), combined with the Ansei-Nankai Earthquake (M8.4) which occurred about 32 hours later, are regarded as a series of Tokai-Tonankai-Nankai-linked earthquakes. (Toshio Okoshi)

□Sources of figures

- 1) Based on the website of the Japan Geotechnical Consultants Association, For management to establish ample and safe national land (Japanese)  
<http://www.zenchiren.or.jp/tikei/index.htm>
- 2) Based on the website of the Headquarters for Earthquake Research Promotion, A survey on earthquakes, Long-term evaluation of active faults (Japanese), 2006  
[http://www.jishin.go.jp/main/p\\_hyoka02.htm](http://www.jishin.go.jp/main/p_hyoka02.htm)
- 3) Based on the website of the Headquarters for Earthquake Research Promotion, Earthquake Research Committee, Regions for evaluation between the Northern part of Sanriku Offshore and Boso Offshore (Japanese)  
[http://www.jishin.go.jp/main/chousa/02jul\\_sanriku/f01.htm](http://www.jishin.go.jp/main/chousa/02jul_sanriku/f01.htm)
- 4) Kazuki Koketsu, Upcoming near field earthquakes and subduction-zone earthquakes, and destructive shaking in the metropolitan area of Tokyo (Japanese)  
[http://www.eri.u-tokyo.ac.jp/daidai/exabs\\_koketsu.htm](http://www.eri.u-tokyo.ac.jp/daidai/exabs_koketsu.htm) (description of "Earthquake Research Committee 2005" is included)

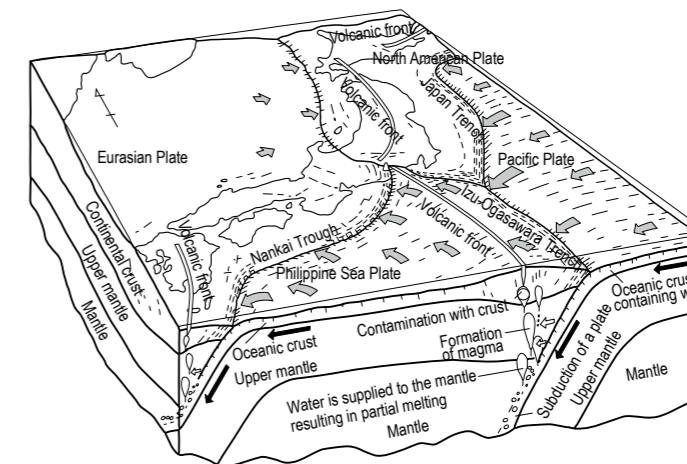

Figure 1. Cross section showing the underground of the Japan islands<sup>1)</sup>



Figure 2. Map of active faults in Japan<sup>2)</sup>

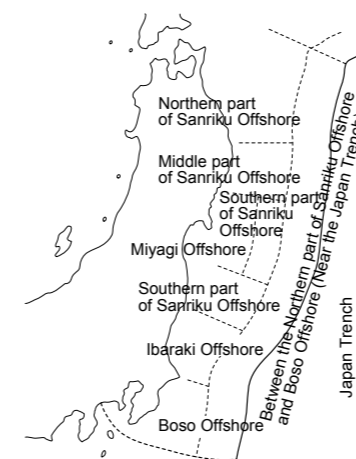

Figure 3. Assumed focal region of subduction-zone earthquakes around the Japan Trench<sup>3)</sup>

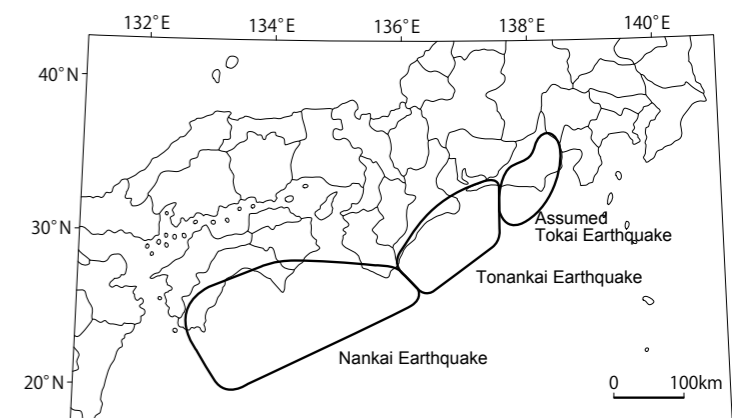

Figure 4. Focal region of subduction-zone earthquakes around the Nankai Trough<sup>4)</sup>

### 1-3 Hyogoken-Nanbu Earthquake

The Hyogoken-Nanbu Earthquake was an urban near field earthquake of M7.3 that occurred on January 17, 1995, with a focus at the Akashi Channel. On the same day a year before in 1994, the North Ridge Earthquake occurred at the West Coast of the United States of America and a freeway bridge collapsed. A researcher in the field of seismic engineering reported to the Japanese Diet that due to the incorporation of earthquake resistant technology such damage would never have occurred in Japan.

#### Great Hanshin-Awaji Earthquake

The Hyogoken-Nanbu Earthquake caused massive damage to Awaji Island and the Hanshin area as well as the Higashi-harima area, Hyogo prefecture. In particular, the urban areas of the City of Kobe suffered catastrophic destruction. In this earthquake, a seismic intensity of 7 hit part of the Hanshin area and Awaji Island for the very first time (Figure 1). The damage was characteristic of earthquakes occurring directly underneath urban areas.

#### Generating mechanism

This earthquake was caused by a rupture of a right-strike-slip fault belt extending from Kobe City to the northern Awaji Island (Figure 2).

In other words, a force in an east-west direction pressed on the crust, and caused a fault rupture in a diagonal direction. In the Kansai region, activities of these faults have created landforms including the Rokko Mountains and Osaka Bay. After the Hyogoken-Nanbu Earthquake, distinct uplift and subsidence of the ground were observed.

The fault rupture occurred first near the central part of the fault, then the rupture extended toward Awaji Island, and lastly toward the Kobe area. The total length of ruptured faults was estimated to be 50 km, and the focus of the earthquake was 16 km below ground in the Akashi Channel.

The area with a seismic intensity of 7 stretched not only to the Rokko Mountains but also toward the east of Kobe City, up to Nishinomiya City and Takarazuka City. The reason why the "disaster belt" extended to the east is assumed to be the directivity (Doppler effect) of seismic waves.

#### Seismic motion

Seismic motions characteristically have a peak at the period of around 1 second as observed in velocity response spectrums, which is called a killer pulse. The natural periods of wooden buildings are about 0.5 second, but they increase to more than 1 second as their plastic deformations progress. In terms of velocity response spectrums, the longer natural periods are, the greater inputs are, and when a deformation reaches about 1/10, buildings collapse due to the P-δ effect (Figure 3).

#### Damage

The Hyogoken-Nanbu Earthquake caused extensive damage with 6,434 deaths, 3 missing people, and 43,792 injured people. An estimated 105,000 buildings were completely destroyed, and approximately 144,000 buildings were partially destroyed. The number of houses burnt down reached 6,148, and the number of families affected reached 9,017.

This was the first great earthquake to hit a large city

area since the 1944 Tonankai Earthquake, and it caused the shredding and complete breakdown of utility lines including electricity, water, gas, and telephone and destruction of roads and railroads, across wide areas.

The total amount of damage was some 10 trillion yen.

#### Wooden houses and the overturning of furniture

About 5,000 people, 80% of the total deaths, were killed by the collapse of houses. In particular, many people were crushed to death while they were sleeping on the first floor. It is calculated that the number of deaths would decrease to 1/10 if there were no out-of-date wooden houses.

A survey estimated that about 600 people, equivalent to 10% of the total deaths, were crushed to death by the overturning of interior furniture.

#### Lessons of the Great Hanshin-Awaji Earthquake

The greatest lesson of the Great Hanshin-Awaji Earthquake was the risk to out-of-date wooden houses and for those buildings built to old earthquake resistance standards. In October 1995, the Act for Promotion of the Earthquake Proof Retrofit of Buildings was enacted. It imposed obligations on the national and local governments as well as citizens to ensure and improve building safety with regard to earthquakes.

Another lesson learned was that the standards for earthquake resistant design established after 1981 were adequate (not including pilotis). However, structural engineers became keenly aware of a different mindset among building owners, whereby damaged non-structural walls or exterior finishes became a justifiable reason for demolishing an essentially sound building.

#### From earthquake prediction to the elucidation of earthquakes

With the Hyogoken-Nanbu Earthquake as a turning point, the Japanese government established the Headquarters for Earthquake Research Promotion, and altered its policy from prediction of an impending Tokai Earthquake to the clarification of earthquake mechanisms. The new approach included the assessment of the long-term probability of occurrence, and the estimation of strong ground motions of earthquakes which would occur in active fault zones, as well as subduction-zone earthquakes. By integrating the results of these activities it was planned to produce national seismic hazard maps for Japan.

By setting up the High Sensitivity Seismograph Network Japan, elucidation of tsunami earthquakes and slow earthquakes, source characteristics of earthquakes, and propagation of seismic motions became possible (Figure 4). However, though the analysis of past earthquakes is possible, prediction of earthquakes is still not possible. (Toshio Okoshi)

□ Sources of figures

- 1) Based on the website of the Kobe City Fire Department, the Great Hanshin-Awaji Earthquake <http://www.city.kobe.lg.jp/safety/fire/hanshinawaji/index.html>
- 2) Kazuyuki Sato, Damage of erosion control facilities—Reporting session on landslide disasters triggered by the Hyogoken-Nanbu Earthquake, handout (Japanese), Japan Society of Erosion Control Engineering, 1995
- 3) Earthquake Research Institute, the University of Tokyo (Furumura) [http://outreach.eri.u-tokyo.ac.jp/eqvolc/201103\\_tohoku/](http://outreach.eri.u-tokyo.ac.jp/eqvolc/201103_tohoku/)
- 4) Hiroaki Yamanaka, Jishin No Yure O Kagakusuru (A Research on the Shaking of Earthquakes), University of Tokyo Press, 2006

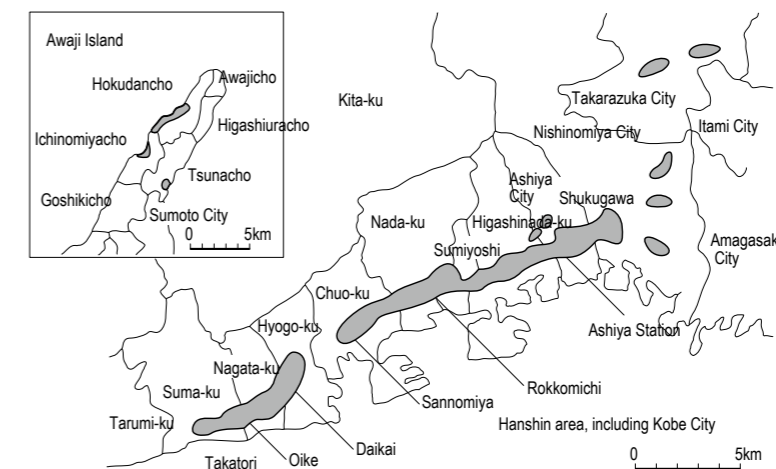

Figure 1. Distribution of areas with a seismic intensity of 7<sup>21)</sup>

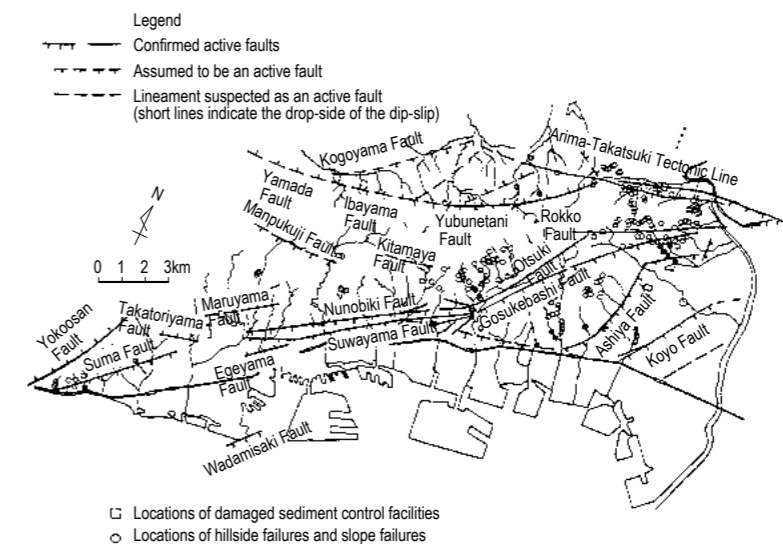

Figure 2. Distribution of failures and locations of faults<sup>22)</sup>

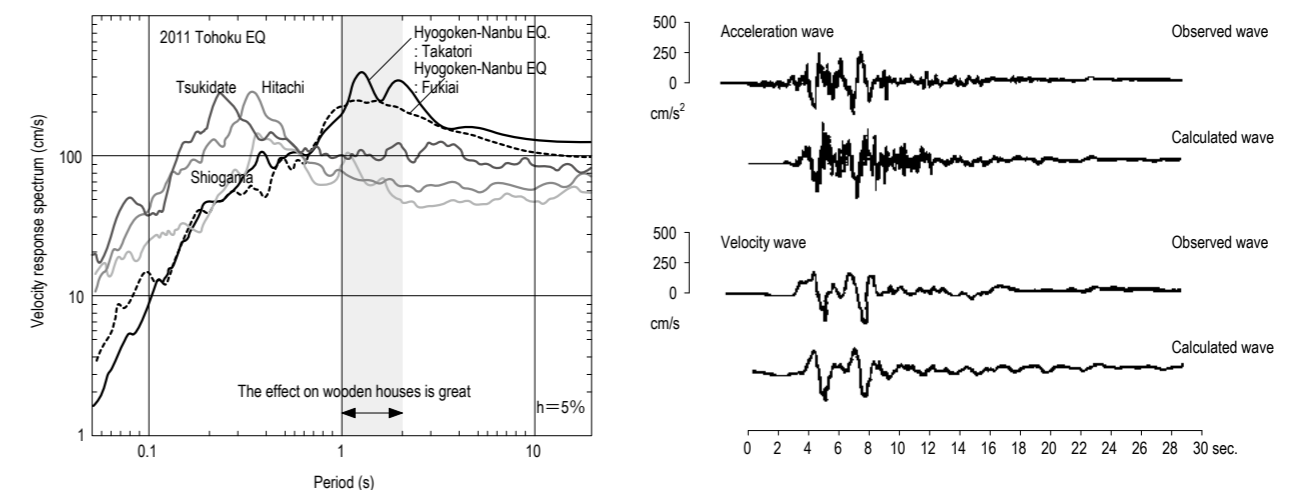

Figure 3. Velocity response spectrums of the Hyogoken-Nanbu Earthquake and 2011 Tohoku Earthquake<sup>23)</sup>

Figure 4. Seismic motion record of 1995 Hyogoken-Nanbu Earthquake reproduced by empirical Green's function method<sup>24)</sup>

## 1-4 2011 Tohoku Earthquake

The Tohoku Earthquake of March 11, 2011, with a focus offshore from Sanriku in the Pacific Ocean. Due to the following great tsunami and liquefaction as well as aftershocks, it caused extensive damage across East Japan from Tohoku to Kanto. In addition, the tsunami damaged the Tokyo Electric Power Company's Fukushima No. 1 nuclear power plant; this event was the first of its kind in history.

### Great East Japan Earthquake

Great tsunamis with a wave height of more than 10 m and a maximum runup height of up to 40.5 m swept across the Pacific coast of the Tohoku and Kanto regions causing catastrophic damage.

Other than the tsunami, the earthquake caused extensive damage, including shaking and liquefaction, ground subsidence, dam failures, and the shredding of utility lines.

The devastation included: approximately 20,000 people killed or missing; 270,000 buildings completely or partially destroyed, 22,000 ships damaged, 23,600 ha of agricultural land flooded, and the total amount of damage was estimated at 16 to 25 trillion yen.

At the Tokyo Electric Power Company's Fukushima No. 1 nuclear power plant, three nuclear reactors were unable to cool down, resulting in meltdown and a serious nuclear accident with the release of large amounts of radioactive substances through venting and hydrogen explosions. The subsequent spreading radiation forced the residents living around the plant and in Fukushima's Hamadori region to evacuate for a long period.

### Generating mechanism

The earthquake, which occurred with a seafloor focus 130 km offshore from the Ojika Peninsula, Miyagi prefecture, recorded M9.0, and its focal region ranged over a wide area of about 500 km in a north-south direction from offshore Iwate to offshore Ibaraki, and about 200 km in an east-west direction. The maximum slippage of faults was 30 m.

By placing the National Research Institute for Earth Science and Disaster Prevention's strong-motion seismograph recordings of the Pacific coast in order, the process of earthquake fault ruptures across 500 km were revealed directly, as well as in detail. The first great fault rupture occurred offshore at Miyagi, and a strong seismic wave was radiated to the whole of East Japan. Tens of seconds later, and farther out offshore from Miyagi a great fault rupture occurred again, and a strong seismic wave was radiated. Immediately after that, the third fault rupture occurred offshore nearer northern Ibaraki, and a strong motion was radiated to the Ibaraki and Tochigi prefectures(1) (Figure 1).

### Tsunami and strong motion

In the ground acceleration and ground displacement at Ishinomaki, Miyagi prefecture, where seismic motion was great, two pulses with a long period of 40 to 50 seconds were observed, and their amplitudes exceeded 50 to 100 cm (Figure 2). This long duration of the motion represents the long process of the fault rupture of a giant earthquake. It is assumed that strong seismic waves were radiated from two great asperities, that is, offshore from Miyagi and Iwate.(1)

According to the Japan Agency for Marine-Earth Science and Technology, it is likely that a crustal deformation of about 50 m southeastward to east-southeastward and about 7 m upward occurred. An uplift of such a vast extent of seafloor caused giant tsunamis with a height of more than 10 m to surge toward the coast.

At the Aneyoshi district of Miyako City, a runup height of 40.4 m was recorded. It was reported that in an area measuring 198 km north to south the maximum height of the water mark exceeded 30 m, in an area 290 km north to south it exceeded 20 m, and in a band some 425 km long the height exceeded 10 m.(2)

### Fires caused by tsunamis

At Yamadamachi and Otsuchicho, Iwate prefecture, large-scale fires blazed in the aftermath of the tsunami, and the central part of Yamadamachi was destroyed by fire. At Kesennuma City, Miyagi prefecture, marine heavy fuel oil spewing from a tank overturned by a giant tsunami caught fire and large-scale blazes spread across the whole of the city.(3)

### Long-period seismic motion

According to the velocity response spectrums recorded by the Earthquake Research Institute, the University of Tokyo, high velocity responses as fast as the 2004 Chuetsu Earthquake occurred at a wide periodic band of 0.5 to 20 seconds (Figure 3), and all kinds of buildings including wooden houses and skyscrapers were greatly shaken by the earthquake.(1)

Osaka's Prefectural Government Sakishima Building, which at 256 m is the highest skyscraper in West Japan and located 800 km from the focus, suffered great damage at a seismic intensity of 3. A rolling motion with a maximum amplitude of 1.36 m which was thought to be the effect of long-period seismic motion lasted about 10 minutes, and 360 points on walls, ceilings, fire doors, etc. were damaged.(3)

### Slope failure and liquefaction

Slope failures and liquefactions occurred over a wide area of the Kanto and Tohoku regions. At a housing development in Shiroishi City, Miyagi prefecture, slope failures, liquefactions, and damage of earth fills occurred (Figure 4). Great damage was observed in the reclaimed lands along Tokyo Bay and waterside areas, and especially, 85% of Urayasu City, Chiba prefecture was subject to liquefaction.

### Lessons of the Great East Japan Earthquake

The damage caused by the tsunamis extended over a wide area. Although tsunami heights and runup heights were the same level as the great tsunami of the Meiji-Sanriku Tsunami, the number of victims at 20,000, indicates the lessons of the past were not effectively used. Large-scale fires caused by tsunamis should be considered in reconstruction plans. On the other hand, reinforced concrete buildings and houses, except those built to old standards, suffered little damage, and demonstrated resistance to tsunamis. (Toshio Okoshi)

#### References

- Website of Earthquake Research Institute, the University of Tokyo, special site of the 2011 Tohoku Earthquake
- Research results of The 2011 Tohoku Earthquake Tsunami Joint Survey (TTJS) Group, April 26, 2012 <http://www.coastal.jp/ttjt/index.php?FrontPage>
- National Institute for Land and Infrastructure Management, Building

Research Institute, Quick Report of The Field Survey and Research on "the 2011 off the Pacific coast of Tohoku Earthquake," 2011

#### Sources of figures

- Earthquake Research Institute, the University of Tokyo (Noguchi and Furumura) [http://outreach.eri.u-tokyo.ac.jp/eqvolc/201103\\_tohoku/#gmsource](http://outreach.eri.u-tokyo.ac.jp/eqvolc/201103_tohoku/#gmsource)
- Earthquake Research Institute, the University of Tokyo (same URL as above)
- Earthquake Research Institute, the University of Tokyo (Furumura and Takemura, same URL as above)
- Edited by the Architectural Institute of Japan, Preliminary Reconnaissance Report of the 2011 Tohoku-Chiho Taiheiy-Oki Earthquake, 2011

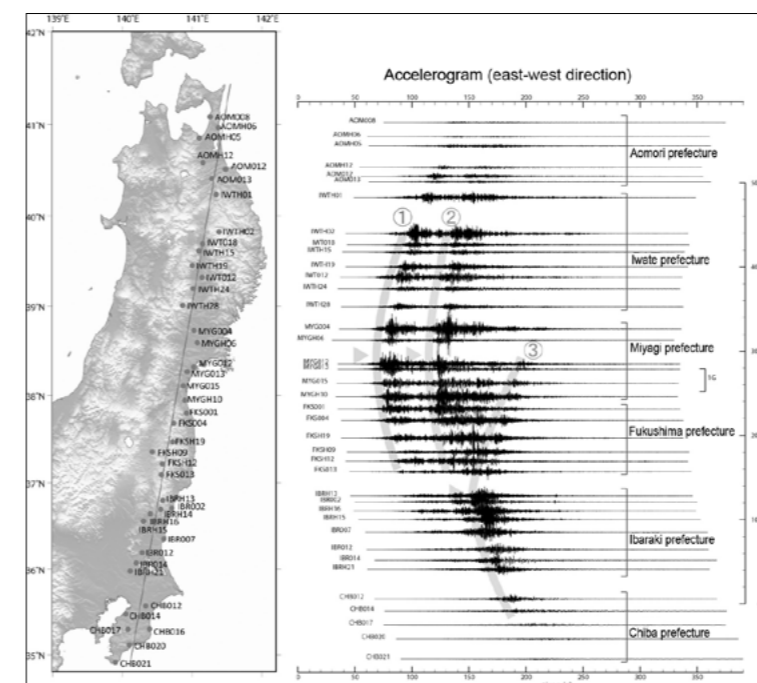

Figure 1. Process of fault ruptures at the focus directly observed in the distribution of seismic motions<sup>1)</sup>



Figure 2. Record of acceleration and displacement of seismic motion at Ishinomaki, Miyagi prefecture<sup>2)</sup>

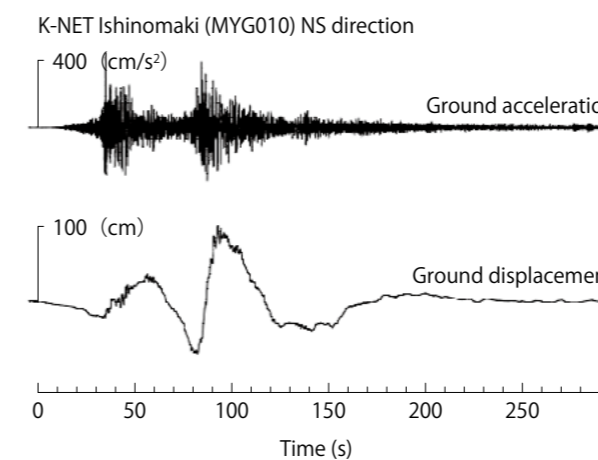

Figure 3. Velocity response spectrum recorded by Earthquake Research Institute, the University of Tokyo<sup>3)</sup>

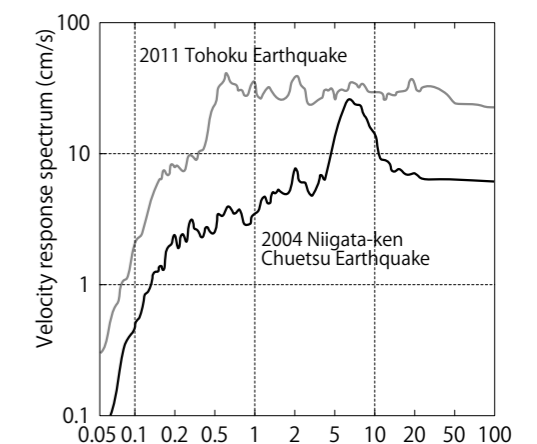

Figure 4. Damage observed at a housing lot development landsite in Shiroishi City, Miyagi prefecture<sup>4)</sup>

## 1-5 Earthquakes and tsunamis in history

Historically, the Japanese are a people who like to record events, both manmade and natural, and fortunately many of the earthquakes and tsunamis of the past have also been recorded. Moreover, the faults and tsunami traces have been excavated and the records of earthquakes and tsunamis have been examined. However, no one knows when, where, or at what scale an earthquake and tsunami will occur in the future.

### Earthquakes at the Japan Trench

Earthquakes that occurred in the Sanriku region include: 869 Jogan-Sanriku Earthquake (M8.3 to 8.6), 1611 Keicho-Sanriku Earthquake (M8.1 to 8.5, seismic intensity of 4 to 5), 1896 Meiji-Sanriku Earthquake (M8.5, seismic intensity of 4) and 1933 Showa-Sanriku Earthquake (M8.1, seismic intensity of 5). They generated little seismic motion but the resulting tsunamis caused great damage, and they are described as tsunami earthquakes, and therefore are also named the Meiji-Sanriku Tsunami and the Showa-Sanriku Tsunami (Figure 1). The 2011 Tohoku Earthquake (M9.0, seismic intensity of 7) occurred at a focal region with a length of 500 km, generated great strong motions and giant tsunamis, and caused extensive damage of the Great East Japan Earthquake.

### Earthquakes at the Sagami Trough

Great earthquakes that occurred along the trough include: 1703 Genroku Earthquake (M8.1, Nojimazaki), after which no great earthquake occurred for 220 years and the 1923 Great Kanto Earthquake (M7.9, Sagami Bay). Odawara earthquakes include: 1633 Kanei-Odawara Earthquake, 1782 Tenmei-Odawara Earthquake, and 1853 Kaei-Odawara Earthquake (M7). Great terrestrial earthquakes include: 1649 Keian-Musashi Earthquake (upper M7), 1855 Ansei-Edo Earthquake (M6.9), and 1894 Meiji-Tokyo Earthquake (M7.0, northern Tokyo Bay to eastern Tokyo metropolitan area) (Figure 2).

The Great Kanto Earthquake caused massive damage by tsunamis with a height of 10 m and by debris flows resulting in 63,600 buildings completely destroyed, 35,400 buildings destroyed by fires, 5,800 people crushed to death, and 25,200 people burnt to death in Kanagawa prefecture. However, the damage caused by fires in Tokyo attracted more attention because of the sheer scale of the devastation with 24,500 buildings completely destroyed, 176,500 buildings destroyed by fires, 3,500 people crushed to death, and 66,500 people burnt to death in Tokyo prefecture. Nevertheless, it was still an earthquake originating in Kanagawa prefecture.

### Earthquakes at the Suruga-Nankai Troughs

The 1604 Keicho-Nankaido Earthquake (M8.0) was a tsunami earthquake with small shakes and about 5,000 deaths by drowning. The 1707 Hiei Earthquake (M8.4) was a Tokai-Tonankai-Nankai-linked earthquake, and it has been assumed to be the greatest earthquake in the recorded history of Japan.

In 1854, the Ansei-Tokai Earthquake (M8.4, including Tonankai) with a seismic intensity of 7 and a tsunami height of 22.7 m hit; and about 32 hours later, the Ansei-Nankai Earthquake (M8.4) with a seismic intensity of 7 and a tsunami height of 16.1 m swept through. Both were giant earthquakes and regarded as a series of Tokai-Tonankai-Nankai-linked earthquakes. Two

days later, the Hoyo Channel Earthquake (M7.4) occurred. Furthermore, the Ansei-Edo Earthquake (M6.9, the mouth of the Arakawa River) occurred in the following year, 1855. They are known as the "Three Ansei Great Earthquakes" (Figure 3).

### Terrestrial earthquakes in the Shinetsu region

The Shinanogawa fault zone is located in the area from Niigata prefecture to the prefectural boundary with Nagano, and consists of 9 faults. Along the extended line in the northeast direction, many large-scale earthquakes have occurred including the 2011 Northern Nagano Prefecture Earthquake, and the Chuetsu, Sanjo, and Niigata earthquakes, the Chuetsu offshore earthquake, and the Middle Japan Sea Earthquake.

Historical documents record the following earthquakes: 1665 Echigotakada, 1714 Itoigawa, 1751 Takada (M7.0 to 7.4), 1828 Echigosanjo (lower M7), and the 1833 Dewa-Echigo-Sado Earthquake. The Echigosanjo Earthquake resulted in 12,900 buildings completely destroyed, 8,300 buildings partially destroyed, 1,200 buildings burnt, and 1,560 deaths.

The 1847 Zenkoji Earthquake (M7.4) left only 142 buildings standing in the city, 2,100 buildings were destroyed or burnt, and the death toll reached 2,486, concentrated in the Japanese-style hotel district where many visitors to the temple were staying. Throughout the region struck by the earthquake more than 8,600 people died, 21,000 buildings were completely destroyed, and about 3,400 buildings were burnt.

### Terrestrial earthquakes in southwest Japan

The 1891 Mino-Owari Earthquake (M8.0) was caused by activities on the Nobi fault belt, resulting in the creation of a fault with a total length of about 76 km, with a maximum vertical displacement of 6 m and 8 m in the horizontal direction. More than 7,000 people were crushed to death and in excess of 140,000 buildings were destroyed.

The 1948 Fukui Earthquake (M7.1) occurred at a left-strike-slip fault in the western part of the fault belt of the eastern marginal area of the Fukui Plain. A total of 930 people died, 12,000 buildings were completely destroyed, 2,069 buildings were burnt, with 79.0% complete collapse, the area burnt covered 641,000 tsubo (2,120,000 m<sup>2</sup>), and it took 5 days to finally bring the fire under control.

### Four great earthquakes

In the mid-1940s, four great earthquakes occurred: 1943 Tottori Earthquake (M7.2) which caused more than 1,000 deaths, 1944 Tonankai Earthquake (M8.0), 1945 Mikawa Earthquake (M6.9), and 1946 Nankaido Earthquake (M8.0).

The 1944 Tonankai Earthquake generated shaking with a seismic intensity of 6. In the Kinki and Chubu regions, a seismic intensity of 5 was observed, and long-period seismic motions lasted for more than 10 minutes in Tokyo.

In the immediate aftermath of the 1946 Nankaido Earthquake, tsunamis swept across the Pacific coasts of the Kii Peninsula, Shikoku, and Kyushu. The number of dead or missing reached 1,440, 11,600 buildings were completely demolished, 1,500 buildings were washed away, and 2,600 buildings were destroyed by fire.

□Reference  
(1) Tatsuo Usami, Nihon higai jishin sōran: Saishinban (A Compendium of Destructive Earthquakes of Japan: latest edition), University of Tokyo Press, 2003

- Sources of figures  
1) Website of Central Disaster Prevention Council, Countermeasures to Subduction-zone Earthquakes Around the Japan Trench and Kuril Trench (Japanese), handout  
[http://www.bousai.go.jp/jishin/nihonkaiko\\_chishima/pdf/gaiyou/gaiyou.pdf](http://www.bousai.go.jp/jishin/nihonkaiko_chishima/pdf/gaiyou/gaiyou.pdf)  
2) Website of Central Disaster Prevention Council, Expert Examination Committee for Countermeasures to Subterranean Urban Earthquakes (Japanese), handout  
<http://www.bousai.go.jp/kaigirep/chuobou/senmon/shutochokka-jishinsenmon/>  
3) Based on the website of the Museum of Fire Safety and Disaster Preparedness  
[http://www.bousaihaku.com/cgi-bin/hp/index2.cgi?ac1=B432&ac2=B43201&ac3=3791&Page=hpd2\\_view](http://www.bousaihaku.com/cgi-bin/hp/index2.cgi?ac1=B432&ac2=B43201&ac3=3791&Page=hpd2_view)

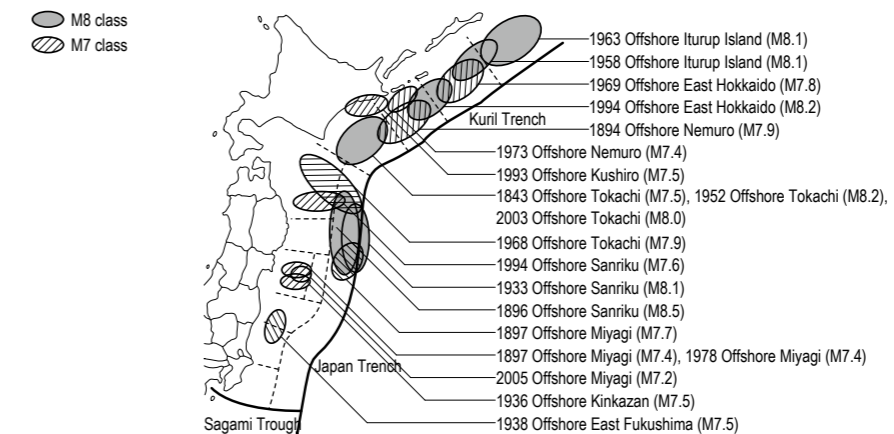

Figure 1. Earthquakes that have occurred at the Japan Trench-Kuril Trench<sup>3)</sup>

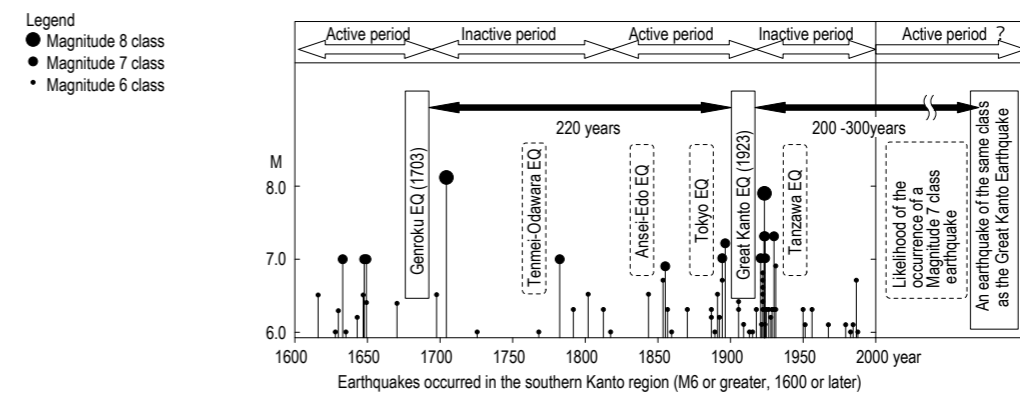

Figure 2. Earthquakes in the southern Kanto region<sup>2)</sup>

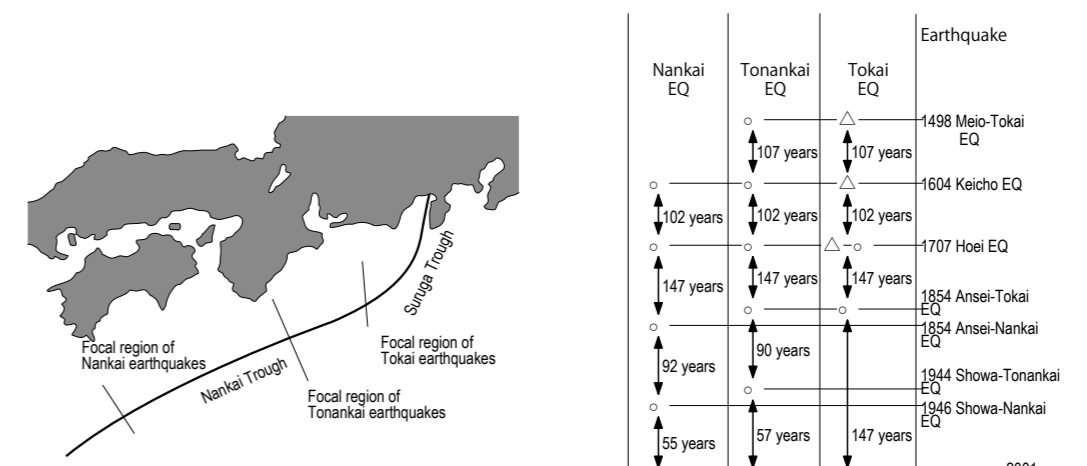

Figure 3. Earthquakes at the Nankai-Suruga Troughs<sup>3)</sup>

## 1-6 Earthquake and seismic motion

When an adhered surface as a part of a fault (asperity) reaches the limit of frictional stress, a sliding failure occurs and propagates along the fault's surface. The frictional energy changes to vibrational energy, and propagates from seismic bedrock to engineering bedrock and on to surface subsoil, and finally appears as seismic motions.

### Rock slip test

The generating mechanism of earthquakes can be simulated by a rock slip test. In the case of a typical sliding failure of brittle rock, the displacement of the rock increases, the rock slides at the peak value of the shear strength and stops at the residual frictional stress. This sliding displacement is called the amount of displacement at failure (Figure 1).

### Magnitude

An increase of the value of magnitude by 1 corresponds to a 32 times greater energy release by the earthquake. There are several scales of magnitude including Richter magnitude, moment magnitude, and the Japan Meteorological Agency magnitude.

The Japan Meteorological Agency magnitude is calculated by using the maximum amplitude recorded by a seismograph which measures strong shakes up to a period of 5 seconds. Calculation will be completed at about 3 minutes. On the other hand, in the case of a giant earthquake with more than magnitude 8, although seismic waves with longer periods show greater amplitudes, those with periods shorter than 5 seconds do not change greatly. In this case, a saturation of magnitude occurs and an accurate estimation of magnitude is not possible. At the time of the 2011 Tohoku Earthquake, as no accurate magnitude could be calculated, it was impossible to warn of the impending giant tsunamis.

### Understanding seismic waves

Seismic motions occur at the focus, propagate in the forms of P and S waves along the earth's crust, enter the deep soil and the surface subsoil, and then reach the ground surface (Figure 2). During the process, surface waves occur, repeat refractions, diffractions, and reflections, thus giving rise to complicated seismic waves at the ground surface.

Seismic waves are observed with accelerometers, velocimeters, and displacement meters. The integrating acceleration creates velocity, and the integrating velocity creates displacement (Figure 3).

As a seismic wave propagates along a continuum, it includes all periods, and they can be resolved into period components by using the Fourier transform. Longer period components show significant displacement and smaller damping, and reach farther. Shorter period components show significant acceleration and greater damping, and rapidly fade. Velocity indicates energy as well as destructive power.

### Seismic intensity

There are several seismic intensity scales including the Japan Meteorological Agency seismic intensity scale, the Mercalli intensity scale, the European macroseismic scale, and the China seismic intensity scale.

The Japan Meteorological Agency seismic intensity scale

is calculated by using acceleration waveforms, and the values of acceleration, periods and duration of shaking are all taken into account. The place with the greatest acceleration is not necessarily the place with the greatest seismic intensity.

The seismic intensity scale is designed to correspond to bodily sensations, the interior situation, wooden or reinforced concrete buildings, the extent of damage of infrastructure, and so on.

### Response spectrum

The specific characteristic of an earthquake is evaluated by using the response spectrum. Depending on the waves to be used, an acceleration response spectrum or a velocity response spectrum is obtained.

The response spectrum is a curve of period responses obtained for different damping factors. Destruction is evaluated by using the velocity response spectrum with a damping factor of 5%.

### Understanding the response spectrum

The natural periods of buildings change according to the displacement levels. In the case of wooden houses, the natural period is about 0.5 second against rare earthquakes, but against extremely rare earthquakes it exceeds 1.0 second. As the response spectrum becomes greater according to the increase of displacement, wooden houses collapse as seen in the Great Hanshin-Awaji Earthquake. In contrast, as it becomes smaller, wooden houses suffer only slight damage as seen in the Great East Japan Earthquake (Figure 4).

### Long-period seismic motion

The natural period of the ground depends on the periods of the surface subsoil and deep soil. The surface subsoil is evaluated by seismic amplification. In a plains area where seismic bedrock is several kilometers deep, long-period seismic motions occur. It is widely known that they are around 7 seconds in Tokyo, 3 seconds in Nagoya, and 5 to 7 seconds in Osaka.

In order for long-period seismic motions to occur, more than 10 seismic waves with the ground's natural period have to be input. Similarly, in order for long-period structures to respond, more than 10 long-period seismic motions have to be input. That is, long-period seismic motions for a certain stretch of time from a great earthquake have to be input. Such motions occurring for a short time will not cause any response.

At the time of the 2003 Hokkaido Earthquake (M8.0), an oil tank in Tomakomai was damaged and caught fire due to oil sloshing, and an oil tank on the coast of Tokyo Bay was also damaged. In the 2011 Tohoku Earthquake (M9.0), skyscrapers in Tokyo swayed for 10 minutes, and an oil tank on the coast of Tokyo Bay caught fire. Even in Osaka, some 800 km from the focus, skyscrapers swayed for about 10 minutes. (Toshio Okoshi)

□ Sources of figures

- 1) Based on Michiyasu Onaka and Mitsuhiro Matsuura, The Physics of Earthquake Generation, University of Tokyo Press, 2002
- 2) Written and edited by Hiroaki Yamanaka, Jishin No Yure O Kagakusuru (A Research on the Shaking of Earthquakes), University of Tokyo Press, 2006
- 3) Masato Motosaka, Actual condition of building damage caused by the 2011 Tohoku Earthquake (Japanese), A short course for JSCA structural engineers, 2011

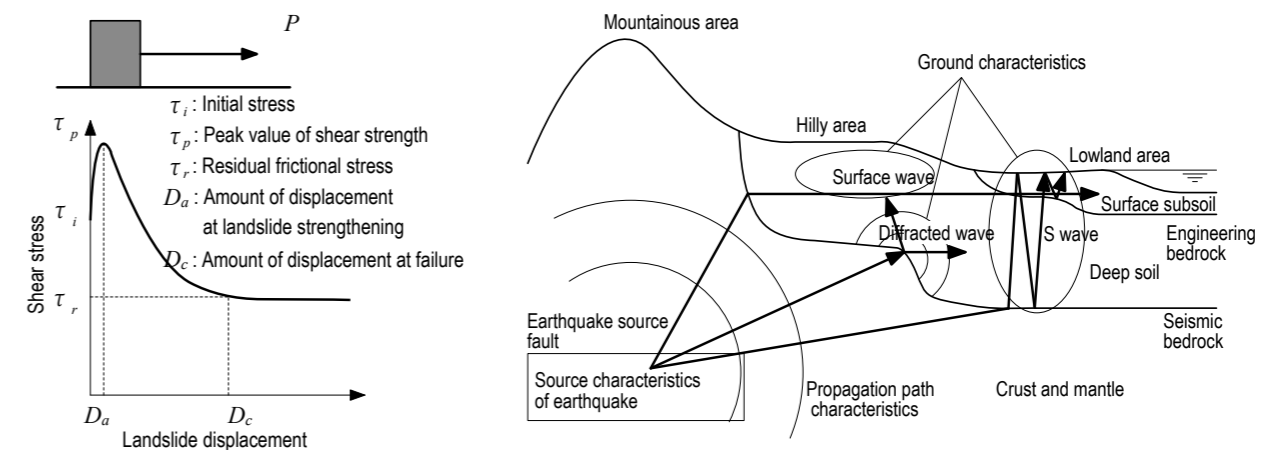

Figure 1. Relation between shear stress and landslide displacement by rock slip test<sup>1)</sup>

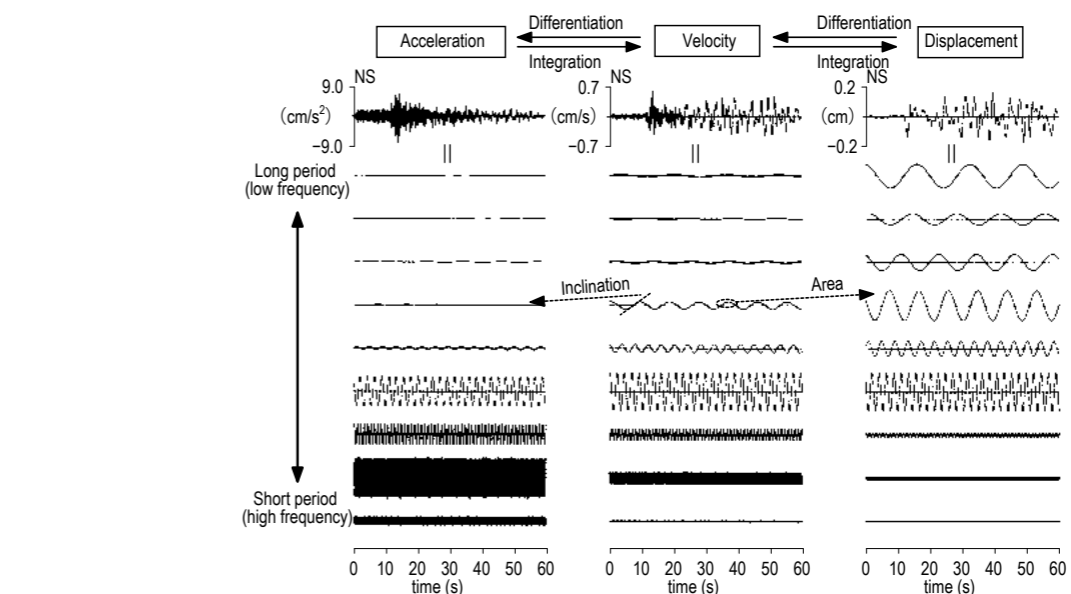

Figure 2. Concepts of seismic bedrock, engineering bedrock, deep soil, and surface subsoil<sup>2)</sup>



Figure 3. Representation of vibration by superposition of periodic functions<sup>2)</sup>

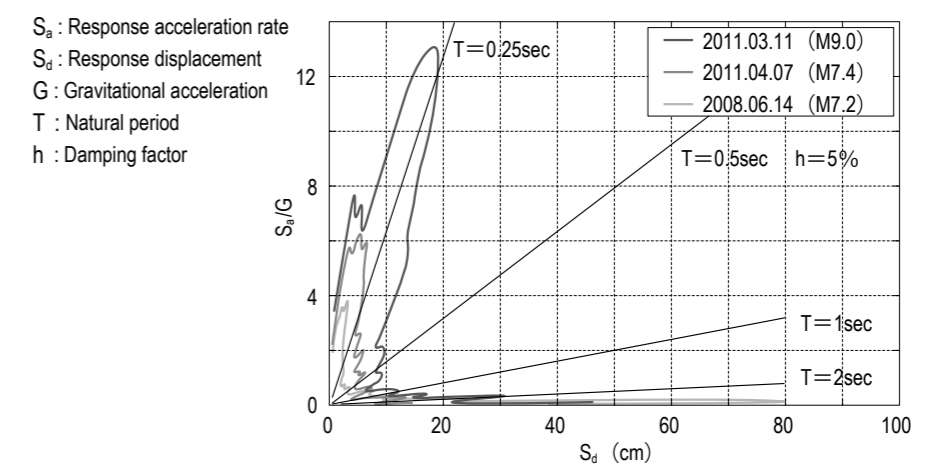

Figure 4. Sa-Sd graph of K-NET Tsukidate<sup>3)</sup>

## 2 Difference in Seismic Performance Depending on the Ground

### 2-1 Points to note concerning the ground

During the Great East Japan Earthquake, liquefaction of the ground occurred over unprecedentedly wide areas, accompanied by great damage with a focus on residential areas. In hilly areas, extensive ground deformation was found, and in addition, due to strong shakes, buildings were left leaning, possibly the result of suspected pile foundation damage.

#### Ground damage of the Great East Japan Earthquake

During the Great East Japan Earthquake, great ground deformation occurred and some damaged buildings collapsed. The ground damage can be summarized by two points.

1. The liquefaction of ground occurred over unprecedentedly wide areas.
2. Large-scale ground collapse occurred at developed housing sites in hilly areas.

During the Great East Japan Earthquake, only one location registered a seismic intensity of 7, and the seismic intensity of the affected areas was a mostly higher to lower 6. Several cases of pile foundation damage were reported. In the case of the very severe Great Hanshin-Awaji Earthquake, areas hit with a seismic intensity of 7 were known as the "disaster belt," and were also affected by the sedimentation conditions of surface subsoil; non-wooden buildings were also subject to great damage. Some building demolition due to pile foundation damage also resulted, and the importance of the earthquake-resistant design of foundations as a preventative measure against great earthquakes was re-acknowledged. Here, I present the topographical criteria for the type of ground and soil to which we should pay attention.

#### Liquefaction of reclaimed land on the coast and low hinterlands

The Great East Japan Earthquake showed evidence of considerable ground liquefaction of reclaimed land on the coast of Tokyo Bay, at a distance of several hundred kilometers from the focus, and a lot of damage including the leaning of houses and foundation damage due to the uneven settlement of the ground. Regarding non-wooden buildings, even though the building itself may have suffered no damage, the surrounding ground sunk and caused slip ups of pile foundations and great damage to exterior elements.

Inland areas of the Kanto region experienced a lot of damage in the areas surrounding rivers including the Tone River system. Possible reasons are that in those housing areas developed on former river beds and their flood plains, such as low hinterlands and marshlands, the original ground was loose sand, and the sand from river deposition layers was used for reclamation.

It used to be explained that liquefaction is "likely to occur at alluvial loose sandy ground with a high groundwater level." It is considered that, during the Great East Japan Earthquake, the very long duration of the earthquake with an intensity of M9 and the drastic increase of the number of actions by repeated shearing stress contributed to making the damage even greater.

#### Ground collapse at housing sites developed in hilly areas

In Sendai City during the Great East Japan Earthquake,

landslides and ground collapse occurred at developed housing sites in hilly areas. Figure 1 shows the patterns of damage to the ground of housing sites prepared by the Japanese Geotechnical Society. In the case of the Great East Japan Earthquake, landslides of natural ground (a) were few, but damage to "trough filled embankment areas," that is, areas developed with reclamation or by the filling of valleys and marshland (b) was great. Furthermore, because the duration of the earthquake was long, "cut and fill boundaries" (c) and "areas with inadequate compaction of embankment" (f) that were susceptible to shakes suffered a lot of damage including building collapse or damage due to settlement or inclination of the ground.

In addition, it is noteworthy that many of the damaged housing sites were non-conforming housing sites built before the 1962 Act on Regulation of Residential Land Development. (1) In response to several great earthquakes including the 2004 Chuetsu Earthquake, this act was amended in 2006 and introduced a two-stage seismic code that prescribes design seismic coefficients as 0.2 and 0.25. In parallel with this, publication of hazard maps for residential land and projects for promoting seismic strengthening of residential land were started by local governments. With regard to a housing site in a hilly area, it is important to understand when the site was developed and the topography before development.

#### Stratum and ground prone to quake amplification

The softer a surface subsoil, the greater a seismic motion input to a building is amplified, and the greater damage to the building including the foundations. The degree of the amplification of seismic motion of the ground can be evaluated by the stratum-specific shear wave velocity. When the ground is especially soft, it is less than 100 m/s. Generally speaking, the deeper from the ground surface, the older strata accumulate, the harder the ground, and the faster the seismic wave propagates. Throughout the long history of the earth, various topographies have been formed due to the folding of the ground and the rise and fall of the sea level. Based on such topography local governments are preparing a "Yureyasusa Map (Map of Weak Subsurface Layers)" to be used for earthquake disaster prevention. For example, Figure 2 shows the degree of amplification of surface subsoil as an increased value of seismic intensity as measured by the Japan Meteorological Agency.

Table 1 shows the relation between engineering geomorphologic classification and the hardness/softness of the ground. The softer the ground, the more it is likely to quake, therefore, this map indicates the degree of quake potential of the surface subsoil. Among these classifications, those from old geologic time, such as the Neogene period, correspond to the topographies of mountain and piedmont. The classifications such as gravel plateau and alluvial fan correspond to well-known "diluvium" areas which are good quality ground formed before the last glacial period. Such classifications as "alluvium" areas, artificial topography, and reclaimed land are more likely to quake. Here, "D" for delta/marsh refers to the distance from the coast (km).

#### Local topography such as hilltops and cliff-tops

Seismic motion is locally amplified at the edge of a cliff-top, hilltop, an uneven edge of basement stratum, etc. Concerning

the damage at Tohoku University which sits on a hillock, it has been pointed out that the ground motion intensity at that point reached twice the level of non-mountainous areas measured during the Great East Japan Earthquake, and it is speculated that some topographic effect was at work. In the earthquake-resistant design for a site with extreme topographical changes, we should err on the side of caution and consult with experts.

#### Sites near an active fault

In order to understand the risk of earthquakes which occur directly underneath urban areas, it is recommended to check a map of active faults. When the map is checked, an active fault may sometimes be found near the site. Some reference information is as follows. Following the Californian "Active Fault Law" which regulates construction within 50 feet of both sides of an active fault, for the first time in Japan, the local government of Yokosuka City introduced district planning

regulations concerning construction within 25 m of both sides of the Kitatake active fault in the city. The local government of Nishinomiya City supervised by local ordinance the implementation of a trench survey of active faults at the time of large-scale development. (Takashi Umeno)

- Reference  
 (1) Website of the Japan Science and Technology Agency, Science News Serial news: Great East Japan earthquake nce News/summary condition of the ground considered: The Japanese Geotechnical Society (Japanese), October, 2011 <http://sc-smn.jst.go.jp/playprg/index/3100>

- Sources of figures  
 1) The Japanese Geotechnical Society, Geo-hazards During Earthquakes and Mitigation Measures-Lessons and Recommendations from the 2011 Great East Japan Earthquake-, 2011  
 2) Cabinet Office, Government of Japan, Technical reference for the preparation of earthquake disaster prevention map (Japanese), March, 2005 <http://www.bousai.go.jp/kohou/oshirase/h17/pdf/050513siryou.pdf>

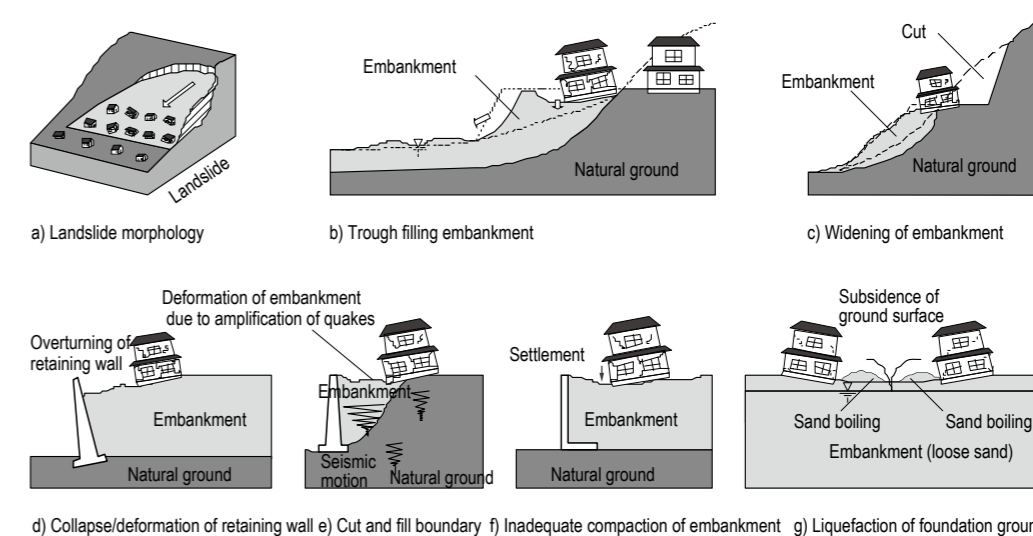

Figure 1. Pattern classification of foundation grounds of housing sites by damage mechanism<sup>1)</sup>

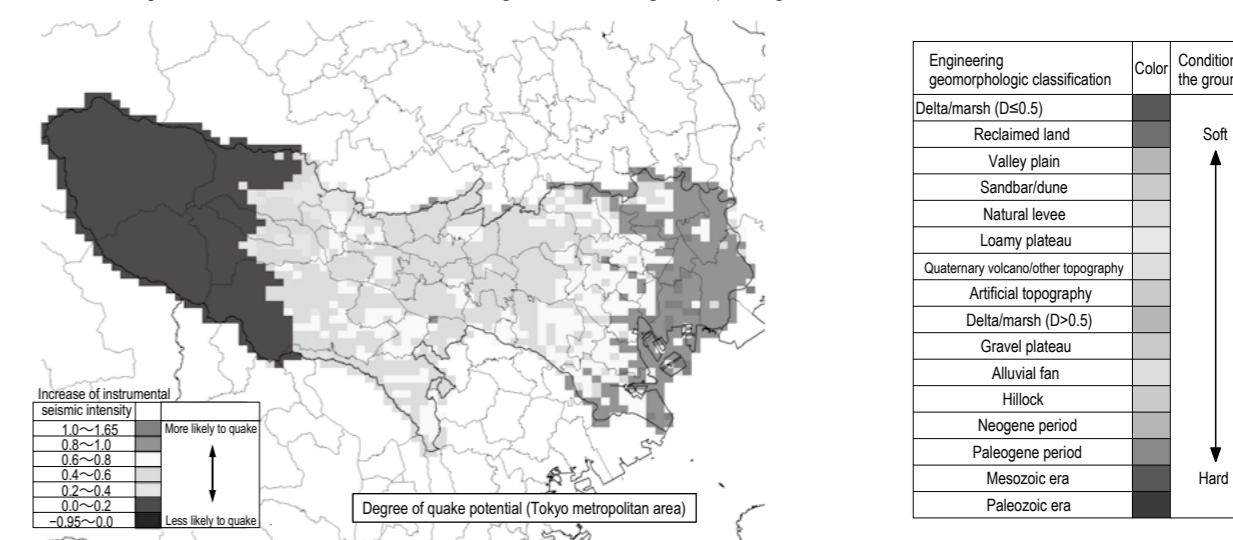

Figure 2. An example of a map of surface subsoil with the degree of quake potential (Tokyo metropolitan area: Distribution of the increase of seismic intensity of surface subsoil)<sup>2)</sup>

Table 1. Engineering geomorphologic classification and assumed condition of the ground considered in the map of surface subsoil with the degree of quake potential<sup>2)</sup>



## 2-2 Quake behaviors vary depending on the characteristics of the ground

The quake behavior of any ground surface is significantly affected by the topography and the geology of the surface, while bearing some relationship to focal mechanisms at the epicenter of an earthquake and the propagation characteristics of any seismic motion. The impact of seismic motion on buildings varies depending on the interaction between the quake characteristics of the buildings and the ground.

### Seismic motion of the ground surface

Seismic motion is caused and emitted by slippage along the faults of solid bedrock. The seismic motion propagates along the bedrock, reaches the ground surface composed of soft sediments, and shakes the surface ground and buildings. Generally, the magnitude of seismic motion becomes smaller the further the distance from the epicenter of the earthquake. However, quake behaviors differ greatly depending on the ground characteristics near the ground surface. This is because the ground surface quakes at the specific predominant period because the seismic motion includes various period elements. This is known as the 'ground amplification effect.' In the current Building Standard Law, the surface ground's amplification effect on the seismic motion is represented as the function of the building's period characteristics according to the classification of the ground right under the building (quake characteristics coefficient:  $R_t$ ). The characteristics of a seismic design motion are defined using the deep underground engineering bedrock (a stratum with a shear wave velocity:  $V_s \geq 400$  m/s), then the assessment of the amplification caused by the upper ground is prescribed. In addition, recent seismic observation and analyses demonstrate the necessity to consider the amplification from the seismic bedrock below the engineering bedrock (bedrock with  $V_s = 3,000$  m/s) in the case of those buildings with long natural periods (super high-rise buildings or base isolated buildings).

### Quake characteristics of buildings and ground

Seismic motion varies depending on the thickness and the degree of softness of the surface ground. The softer and thicker the surface ground, the greater the degree of amplification (Figure 1). Usually, it is the acceleration amplitude which increases; however, care should be taken because depending on the stratum the velocity may be amplified even when the acceleration decreases.

Regarding the relationship between the building and the ground, the seismic motion that has reached the ground surface (or the foundation bed) will divide into a wave which propagates into the building (input wave) and a wave which returns to the ground (emitted wave). The proportion of these two waves varies depending on the interaction between the building and the ground. Any building has a property to pick up and to resonate with the component of the seismic motion that matches to its quake characteristics. Therefore, it is important to understand the quake characteristics (basically, the natural periods) of the ground and the building.

### Ground classifications and Standard for Earthquake Resistant Design

In the Standard for Earthquake Resistant Design after 1981 in Japan, the value of the quake characteristics coefficient

( $R_t$ ) is specified in relation to the predominant period of the ground ( $T_c$ ) and the natural period of the building, in the relational expression for the calculation of the seismic shear coefficient of the building (the rate of the seismic design force against the weight of the building) (Figure 2). The horizontal axis of the figure represents the building's primary natural period ( $T$ ), and the vertical axis represents the quake characteristics coefficient ( $R_t$ ). The figure shows that the maximum value of  $R_t$  is 1.0, and the harder the ground, the smaller the value of  $R_t$ , that is, the smaller the seismic force applied to the building. The ground falls into the following three classifications:

1. Type I ground: bedrock, hard gravel layer, and other strata, which were mainly formed in or before the Tertiary period.
2. Type II ground: those grounds other than Type I ground and Type III ground.
3. Type III ground: alluvia of humus or mud with a thickness of about 30 m or more, or reclamation layers less than 30 years.

### Earthquake response and resonance

Regarding the Great Kanto Earthquake of 1923, it has been estimated that the acceleration was around 300 to 400 gal in the old town areas of Tokyo with a soft ground, and was around 100 gal in the uptown areas with a hard ground. It has been considered that the difference in quake magnitude due to the surface ground characteristic difference caused such a variance in the accelerations. In the old town area, wooden buildings with relatively long periods accounted for a high percentage of the damaged buildings, while in the uptown area, earth wall buildings with relatively short periods accounted for the highest percentage. And it has been considered that such building damage difference is correlated to the natural period (the primary period) of the buildings (Figure 3).

As an example, Figure 4 shows the relation between typical seismic waves and the response of buildings as the parameter of natural periods ( $T$ ). A low-rise building with a shorter period ( $T=0.5$  sec.) shakes the most with a greater acceleration. The super high-rise building with a longer period ( $T=2.0$  sec.) shakes gently with a smaller acceleration. The medium-rise building with a medium period ( $T=1.0$  sec.) shakes moderately with a moderate acceleration. The building response is not determined simply in relation to the primary period of the building because the period characteristics of the seismic motion are complicated. However, the figure shows that the building with a shorter period responds more to the seismic motion of a relatively short period, while the building with a longer period responds less to the same seismic motion. When the predominant period of the building is close to the building's natural period, the building shakes very much due to the resonance. In earthquake-resistant designs, therefore, it is important to avoid the occurrence of resonance phenomena.

In the Tokachi-oki Earthquake of 2003 and the earthquake of 2011 off the Pacific coast of Tohoku, long period seismic waveforms were observed and due to resonance long period structures swayed back and forth even at a distance of several hundred kilometers from the epicenters. The effects of resonance phenomena on super high-rise buildings and base isolated buildings in such cases are also a matter of concern.

(Mitsugu Asano)

□ Sources of figures

1) Edition by the JIA Urban Disaster Committee, the Japan Institute of Architects, "Earthquake-resistant Building Design for Architects," Shokokusha, 1999

2) Edition by Masataka Ando and Toshikatsu Yoshii, "Jishin: Rika nen-nyo-dokuhon (Earthquake :a Chronological Scientific Tables' reader)," Maruzen, 1993

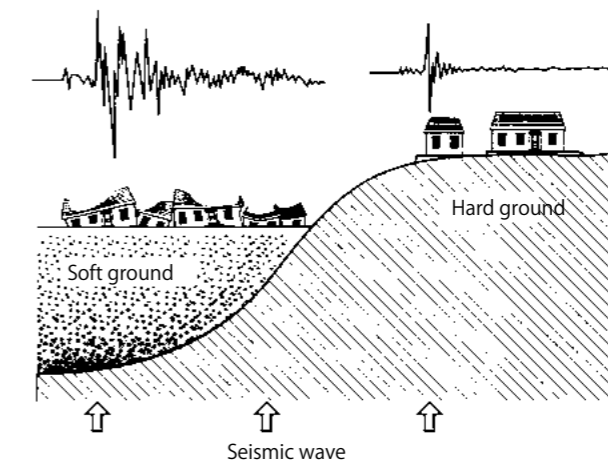

Figure 1. Seismic wave<sup>1)</sup>

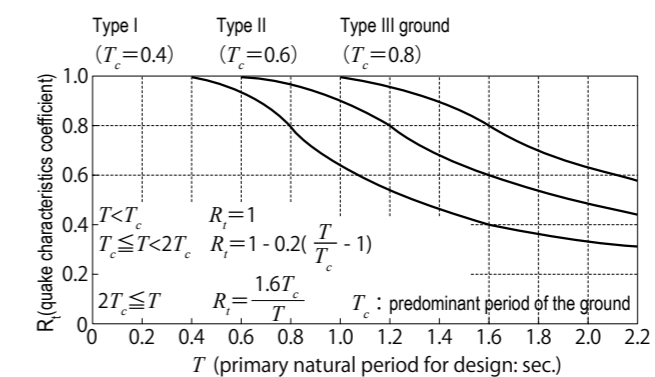

Figure 2. Quake characteristic coefficients specified in Standard for Earthquake Resistant Design after 1981 in Japan<sup>1)</sup>

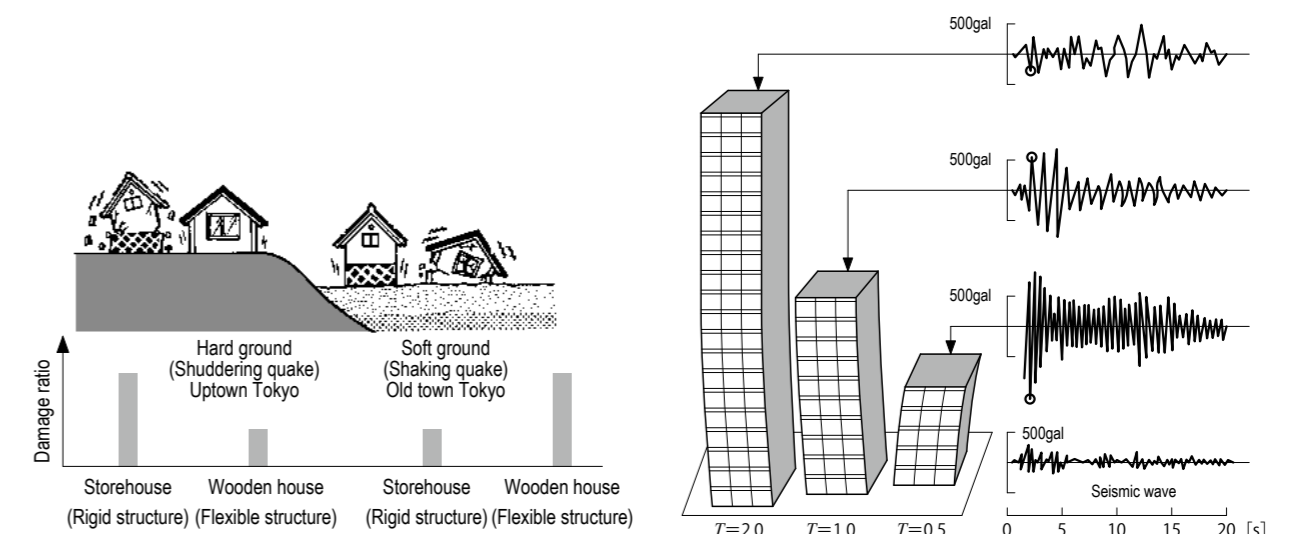

Figure 3. Building damage caused by the Great Kanto earthquake of 1923<sup>1)</sup>

Figure 4. Relationships between the natural periods of buildings ( $T$ ) and the earthquake response<sup>2)</sup>

## 2-3 Sites prone to liquefaction

Liquefaction usually occurs at places with loose sandy soil and a high groundwater level, including the reclaimed land of bay areas, large-scale lowlands along a river, and land created by reclaiming such lowlands. Liquefaction maps and liquefaction occurrence histories are also useful. In addition, it is necessary to check ground surface subsidence and lateral flow with a more detailed evaluation of potential liquefaction following architectural guidelines.

### Sites prone to liquefaction

Liquefaction usually occurs at alluviums with loose sandy soil and a high groundwater level, where relatively little time has passed since its sedimentation; even so, in geologic time, this means some 20,000 years ago.

The soils that meet such conditions include the reclaimed land of bay areas, large-scale lowlands along a river (especially, meander scars and former marshland), and land created by reclaiming such lowlands. This information is available on old maps and land condition maps provided by the Geospatial Information Authority of Japan. When a site corresponds to these conditions, there is some risk of liquefaction (Figure 1).

Furthermore, many local governments (including prefectures and ordinance-designated cities) have prepared and are disclosing liquefaction maps (Figure 2). However, disclosure is varied, some are available on websites such as the Hazard Map Portal Site of the Ministry of Land, Infrastructure, Transport and Tourism, and others only from government offices.

Liquefaction maps have been prepared for the potential earthquakes in an area, and therefore, there are plural liquefaction maps provided by one local government. In most maps, the subject area is divided into 50 to 500 m grids and the liquefaction risk evaluated for the typical topography/stratum of each cell is shown. In some cases, within an individual grid cell there are great differences of topographical conditions and/or situations of developed sites. Therefore, evaluating the liquefaction risk of a specific building site requires great caution.

In addition, ground subject to liquefaction is likely to liquefy again at the next earthquake. Commercially available "Maps for Historic Liquefaction Sites in Japan" may also be used as a reference.

### Simple assessment of liquefaction

The "Recommendations for the Design of Building Foundations" (Recommendations for Building Foundations, hereafter) published by the Architectural Institute of Japan, which is used by architectural structure engineers, gives a simple method for assessing the risk of liquefaction based on the results of a bore survey and an indoor soil test (FL method). This is a method for assessing the liquefaction risk of alluvium up to a depth of 20 m, using indicators including the standard penetration test result (N value), the content of percentage of fine particles in sandy ground, the groundwater level, as well as the anticipated magnitude and duration of seismic motion.

On the other hand, the "Recommendations for Designing of Small Buildings Foundations" (Recommendations for Small Buildings, hereafter) published by the Architectural Institute of Japan gives a method for evaluating the effect of liquefaction on the ground surface of item 4 buildings (small buildings such as detached houses) based on the result of the Swedish weight

sounding test (Figure 3). This method is based on the concept that when a non-liquefied surface layer with some thickness exists on the ground surface, there is little effect from sand boiling, etc., even if a layer underneath is liquefied (Figure 4). However, the method used by the Recommendations for Small Buildings does not cover all of the seismic motions and ground conditions with their many variable characteristics, because only simplified conditions are included. Using this method requires caution concerning the difference in applied conditions.

### Subsidence/horizontal displacement of the ground due to liquefaction

Even if any liquefaction risk of a site is assessed as high by the above-mentioned FL method, it is still not possible to decide the design of foundations and the needs of countermeasure construction methods, if the extent of risk is not clear.

The Recommendations for Building Foundations gives a prediction method for the amount of ground surface subsidence when liquefaction occurs. When the predicted amount of ground surface subsidence is great, some form of liquefaction countermeasures should be considered. When it is small, it may be permitted and symptomatic responses may be taken on the structure side. The amount of ground surface subsidence based on the method of Recommendations for Building Foundations is not necessarily highly accurate because ground surface subsidence occurs due to not only ground surface subsidence, but also other factors. However, it is adequate as a rough guide.

When liquefaction occurs, not only ground surface subsidence but also the lateral flow of the ground occurs at sites near rivers and coasts. During the 1964 Niigata Earthquake, it was recorded that the revetment of the Shinano River was horizontally displaced to a maximum of 10 m (Figure 5). Attention should be paid because horizontal displacement of a revetment can affect an area as far as 100 m in an inland direction.

(Tetsuo Tabei)

□ Sources of figures

- 1) Website of Kawasaki City
- 2) Edited by the Architectural Institute of Japan, Recommendations for Designing of Small Buildings Foundations, 2008
- 3) Masanori Hamada, Susumu Yasuda, Ryoji Isoyama, and Katsutoshi Emoto, Observation of Permanent Ground Displacements Induced by Soil Liquefaction, proceedings of the Japan Society of Civil Engineers, No. 376, III-6, 1986

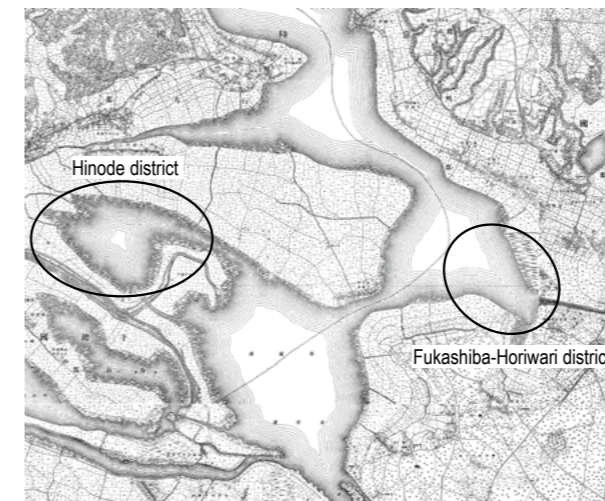

Figure 1. An old map of the Meiji era (Areas including Hinode district of Itako City, Ibaraki prefecture, where liquefaction occurred at the time of the 2011 Tohoku Earthquake, were land reclaimed from the sea.)

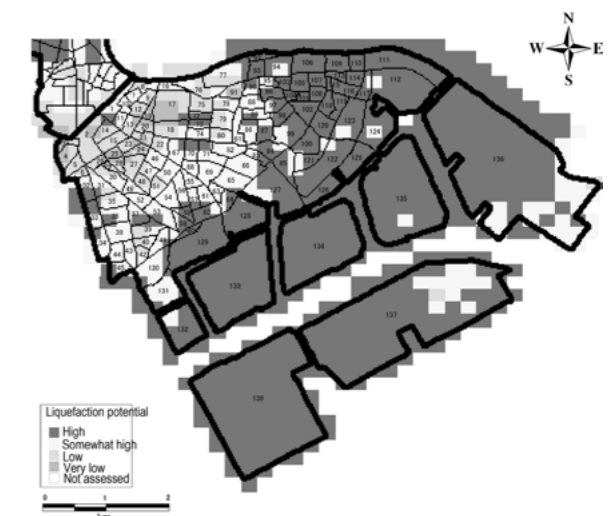

Figure 2. Liquefaction map (Kawasaki-ku, Kawasaki City, Kanagawa prefecture)<sup>1)</sup>

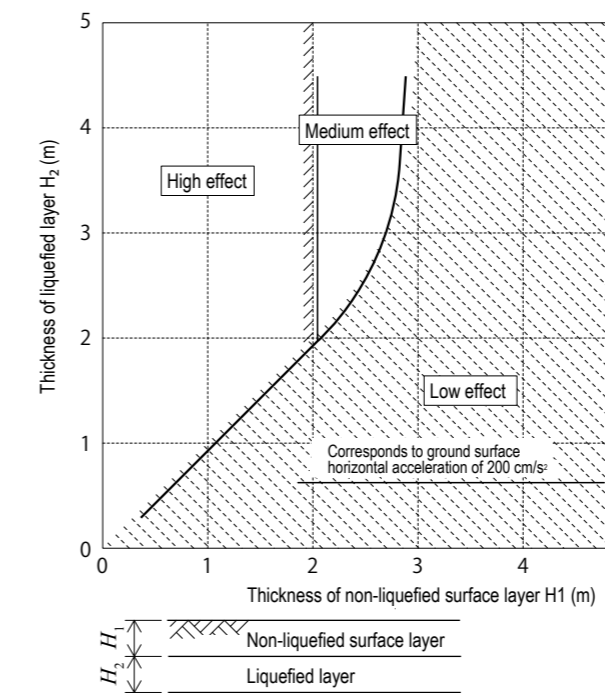

Figure 3. Extent of the effect of liquefaction on the ground surface<sup>2)</sup>

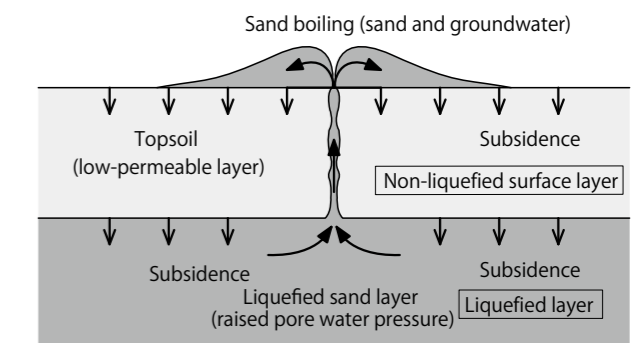

Figure 4. Image of sand boiling

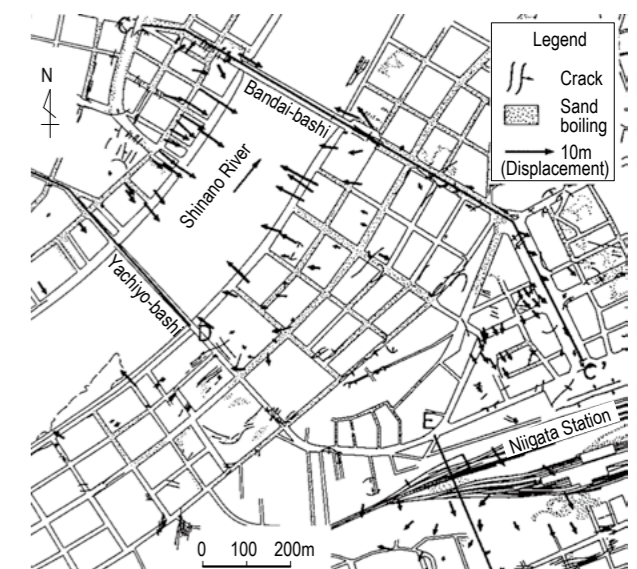

Figure 5. Lateral flows of the ground around a river (1964 Niigata Earthquake)<sup>3)</sup>

## 2-4 Countermeasures against liquefaction

Although the structures which are subject to countermeasures against liquefaction include buildings, utilities, outdoor facilities, and other structures, the construction methods for liquefaction countermeasures also depend on conditions and such factors as whether a building is newly-built or already existing, or if an area is an individual site or an integrated improvement involving the surrounding roads. Furthermore, minimizing uneven settlement on the structure side while allowing liquefaction, or taking no countermeasures while taking out earthquake insurance are also options.

### Mechanism of liquefaction

Sandy soil consists of sand particles and groundwater which fills the gaps. Because sand particles originating from hard rock usually contact and support each other, ground surface subsidence seldom occurs, and it is classified as supporting soil of good quality.

When shear stress caused by an earthquake acts repeatedly on the ground, the movement of sand particles in loose sandy ground occurs, and the ground transforms to a more compact state. Then, gaps between sand particles shrink, and pore water pressure is raised following Boyle's law (Figure 1). At this state, contact forces between sand particles decrease according to the increase of water pressure, and when the water pressure reaches the weight of soil above at each depth (overburden stress), contact forces between sand particles fall to zero, and the sandy soil as a whole starts to behave like soft mud. This is the essential mechanism of liquefaction.

### Basic principles for liquefaction countermeasures

In order to prevent liquefaction, countermeasures based on the following principles are taken (Table 1):

1. By compacting loose sandy ground in advance, suppress the decrease of volume and the increase of pore water pressure during the earthquake.
2. Solidify pore water by replacing with cement milk, etc.
3. Dissipate raised pore water pressure in some way.
4. Suppress the increase of pore water pressure by mixing air or micro bubbles in pore water.
5. Suppress horizontal displacement (shear deformation) of the ground during the earthquake.

### Classification of construction methods for liquefaction countermeasures

Liquefaction countermeasures are divided roughly into three categories:

1. Reduce risk of the occurrence of liquefaction with liquefaction countermeasures.
2. Respond with work on the foundation structure of the building.
3. Take no countermeasures.

1 includes various construction methods based on the above-mentioned basic principles for liquefaction countermeasures.

2 includes various methods that can minimize uneven settlement when liquefaction occurs, or those methods that enable easy repairs even if liquefaction occurs. Specifically, the following countermeasures are taken:

- A) Cast pile foundations to an adequate depth below the liquefied ground.
- B) Adopt a mat foundation structure that suppresses uneven settlement.
- C) Install jacks below the foundation in advance (Figure 2), or build the foundation so that jacks are able to be installed after the earthquake has struck.

3 involves taking out earthquake insurance, and implementing liquefaction countermeasures or subsidence correction after the earthquake has struck. This approach is rational when considering the life of a building and the probability of liquefaction, and in the case of a detached house, the fact that liquefaction countermeasure costs are considerably high compared to construction costs.

### Subject and scope of liquefaction countermeasures

Buildings vary from skyscrapers to detached houses and from large buildings to small ones. For the provision of utilities, there are buried pipes including those for water, sewage, electricity, and gas. Furthermore, there are outdoor facilities and other structures including passages, fire prevention water tanks, pit type parking lots, and inclined retaining walls in a housing complex. Liquefaction countermeasures should be selected in consideration of their scale and importance, the degree of effect of liquefaction damage, the degree of difficulty in repairing, etc.

In addition, buildings, utilities, outdoor facilities, and other structures consist of both newly-built ones and existing ones. Therefore, it is necessary to select appropriate construction methods for liquefaction countermeasures according to the individual construction environment.

During the 2011 Great East Japan Earthquake, in the Urayasu area of Chiba prefecture, roads also suffered great damage. In this area, even where houses were not affected by liquefaction, daily life was disrupted because utilities were seriously damaged. Based on such cases, discussion has started concerning countermeasures, such as integrated improvements including the surrounding roads or an area as a whole.

The Urayasu area had suffered wide-area subsidence before the 2011 Great East Japan Earthquake. Therefore, buildings with foundation piles were equipped with flexible joints at their connection points for water, sewage, and gas pipes, taking into account the anticipated difference in level between buildings and the peripheral ground. However, at some sites in the area, the peripheral ground sank more than 50 cm due to liquefaction, causing connecting parts to break, and earth and sand flowed into the pipes causing restoration problems. Connecting parts require countermeasures such as adding elasticity to the flexible joints, or as much as possible reducing the number of connecting parts (Figure 3). (Tetsuo Tabei)

□ Sources of figures

- 1) Yoshiaki Yoshimi and Kiyoshi Fukutake, Jiban ekijoka no butsuri to hyoka taisaku gijutsu (Physics of ground liquefaction and evaluation/countermeasure technology), Gihodo Shuppan, 2005
- 2) Edited by the Architectural Institute of Japan, Guideline for Designing Foundations of Small Buildings, 1988

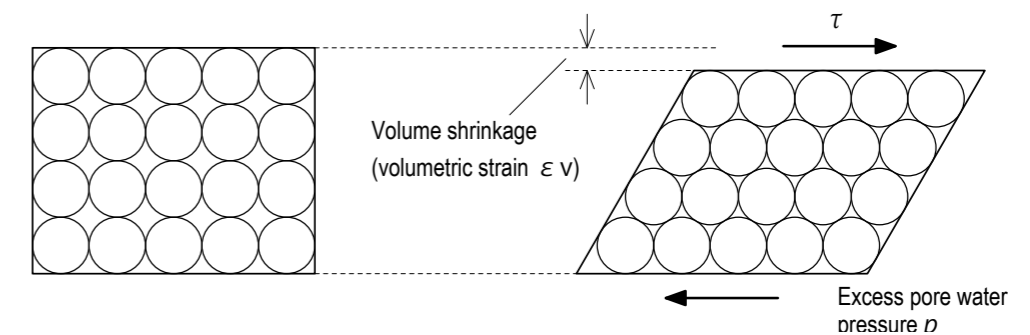

Figure 1. Volume shrinkage due to shearing of loose sand<sup>1)</sup>

Category of construction method	Typical construction method	Summary of construction method	Construction results (effect confirmation)	Applicable structure	Applicability to existing building
Increase of density (compaction)	Sand compaction pile	Compact loose sand by enforced press fitting of sand piles and vibration.	Many results and effects have been confirmed.	Appropriate for liquefaction countermeasure of large suburban areas, because vibrations are generated.	Inappropriate, because soil improvement directly under a building is difficult.
	Vibroflotation	Compaction by vibration rod and crushed stone grouting. Has drainage effect.	Same as above. Few results in recent years.		
	Compaction grouting	Grouting low-fluidity soil mortar. Compaction of sandy ground through the process of continuously constructing bulb-like solidified substances.	Many results, especially airports, etc. Effects have been confirmed.	Appropriate for construction at sites including airports, general buildings, and narrow sites of warehouses.	Soil improvement directly under a building is possible by making holes in floor slabs.
Solidification	Deep mixing	Mixing solidification material (ex. cement) with soil and constructing soil-cement columns.	Some results and effects have been confirmed.	Apply together with foundations of general buildings.	Inappropriate, because soil improvement directly under a building is difficult.
	Chemical grouting	Grouting chemical liquid into loose sandy ground with low pressure and replacing pore water.	Many results and effects have been confirmed.	Used for narrow sites, because material cost is high.	Soil improvement directly under a building is possible by oblique grouting from outside the building.
Dissipation of pore water pressure	Graveled lane	Forming crushed-stone columns underground using auger casing.	Few results and effects are unclear.	Buildings that allow subsidence (subsidence will occur after an earthquake).	Inappropriate, because soil improvement directly under a building is difficult.
	Peripheral drainage lining	Placing artificial drainage material into holes formed by using an auger at predefined distances.	Some results, especially manholes, and effects have been confirmed.	Small outdoor facilities that allow subsidence of manholes.	Effective for small structures such as manholes.
Decrease of saturation	Micro bubble injection	Injecting air or micro bubbles from a well and desaturating the ground under structure.	No results because the method is under development.	Small buildings	Soil improvement directly under a building is possible by injecting on both sides of the building and establishing a well for pumping.
Suppression of shearing deformation	Grid-shaped improvement	Mixing solidification material (ex. cement) with soil and constructing grid-shaped improved ground.	Many results and effects have been confirmed.	Item 1 - item 3 buildings	Inappropriate, because soil improvement directly under a building is difficult.
	Closing by sheet piling	Placing sheet piles around a building and connecting their heads with tie rods.	Many results, especially road and railway embankments. Effects have been confirmed.	Long and narrow embankment structure such as that of roads and railways.	Inappropriate, because connecting the heads of sheet piles is difficult.

Table 1. List of typical construction methods for liquefaction countermeasures

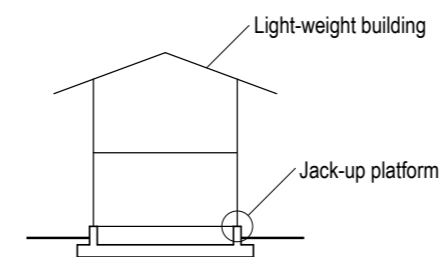

Figure 2. Mat foundation with jack-up platform<sup>2)</sup>

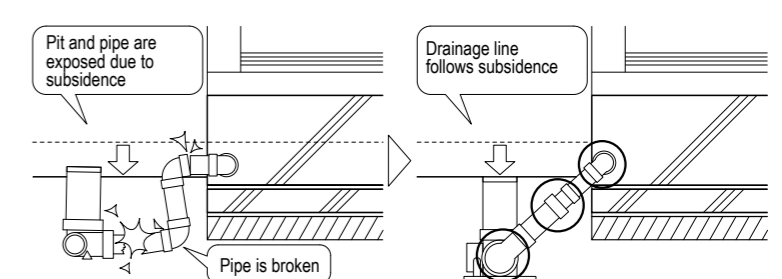

Figure 3. Universal joint and expansion joint

## 2-5 Seismic ground failure of developed land

During great earthquakes large-scale developed lands made by cutting ridges and filling the valleys of hilly areas and those lands made by reclaiming lowlands (especially, former river beds, marshlands, and deltas, etc.) repeatedly suffer the sliding of slopes and damage due to liquefaction. Although the state has instituted subsidy systems for countermeasure works, they are not implemented very well because the individual expense is too great. Countermeasures against illegal retaining walls are also needed.

### Seismic ground failure of developed land on hillsides

In suburban areas, building lots have long been made by developing hillside areas. In many cases, valleys were simply filled with earth and sand cut from ridges (called cut and fill development), and tiered platform lots were made along the slope.

During the 1978 Miyagi Earthquake, older tiered platform lots in Sendai City and Shiroishi City, Miyagi prefecture suffered damage (Figure 1). Especially, valley filled parts were subject to landslides, and the subsidence of landslide heads and forming of scarps, swelling of edges, and side cracks were all observed. These areas suffered ground transformations again during the 2011 Tohoku Earthquake. During the 1995 Great Hanshin Earthquake, landslides of valley filled parts occurred at many places, especially in Kobe City and Ashiya City. Moreover, during the 2004 Chuetsu Earthquake, the collapse of valley filled parts as well as shear failures of building foundation piles were verified (Figure 2).

Why does damage to valley filled parts repeatedly occur during earthquakes? It is considered that topographically valleys are apt to collect water, and as the groundwater level inside the filled section raises, the weight of the filling increases. It would also seem that the boundary area between the filling and the original ground loosens and shearing resistance (skid resistance) decreases. Another reason is that horizontal acceleration during the earthquake is greater at a sloped part compared with a flat part. It should also be noted that in those cases where sand was used at the lower part of a filling, liquefaction occurred during the earthquake and this section was prone to slide, and the filled part slid some way down.

### State measures for large-scale developed land

During the 1995 Hyogoken-Nanbu Earthquake, seismic damage occurred extensively to large-scale developed land in hilly areas including valley filled parts, and the issue of their poor earthquake resistance drew attention. In response to this, the Act on the Regulation of Residential Land Development was reviewed in 2006, and the following two subsidized projects were instituted:

1. Transformation estimation of large-scale filled land (preparation of building land hazard maps to be implemented by local government)
2. Prevention of the sliding and collapse of large-scale filled land projects (sliding and collapse prevention work to be implemented by local government and landowners)

Most preparation work for hazard maps (1) has been completed by local government. As for the sliding and collapse prevention work (2) shown in Figure 3, very few projects have been implemented because of problems including the finan-

cial difficulties of local governments and the expenses borne in principle by landowners.

### Seismic ground failure of reclaimed lowland

In suburban areas, building lots are being developed by reclaiming marshlands, former river beds, and deltas near coasts which were previously unusable for building. In many cases sand, which is easy to be compacted and does not experience subsidence, and thus may be expected to have an adequate bearing capacity, is used as material for reclamation. During the 2011 Tohoku Earthquake, loose sandy ground which had been deposited on lowland together with filling sand experienced liquefaction, and extensive seismic damage. Damage due to liquefaction in the Tokyo Bay area included Urayasu City of Chiba prefecture as a representative example. In addition, in the Fukashiba district of Kamisu City, Ibaraki prefecture, a building lot which had been developed by filling a former rice field and constructing an L-shaped retaining wall with a height of about 1 m experienced liquefaction, and the detached house built on it was subject to inclination and sinking (Figure 4).

### Damage of retaining walls vulnerable to earthquake

During the 1995 Great Hanshin-Awaji Earthquake, the 2004 Chuetsu Earthquake, and the 2007 Chuetsu Offshore Earthquake, extensive damage to retaining walls was noted, particularly to masonry and concrete-block retaining walls and leaning concrete retaining walls. It was thus verified that these types of retaining walls have low earthquake resistance.

Dry masonry retaining walls (spaces between stones are not filled with cement, etc.), increased retaining walls (wall height is increased by stacking concrete blocks, etc. directly onto a retaining wall), and double retaining walls are all unstable and illegal (Figure 5). They suffered a lot of damage during the above-mentioned earthquakes, and it is better to consider replacing or reinforcing them to increase their earthquake resistance.

(Tetsuo Tabei)

□ Sources of figures

- 1) Edited by the Architectural Institute of Japan, Preliminary Reconnaissance Report of the 2011 Tohoku-Chiho Taiheiyō-Oki Earthquake, 2011
- 2) Urban and Regional Safety Affairs Division, City and Regional Development Bureau, Ministry of Land, Infrastructure and Transport, Working to Build Safe and Secure Communities, 2006
- 3) City Planning Division, City and Regional Development Bureau, Ministry of Land, Infrastructure and Transport, Engineering Manual for the Reconstruction of Residential Areas Damaged by Natural Disasters (Tentative Edition), December, 2004



Figure 1. Damage to a valley filled building lot (Yamamoto-cho, Watari-gun, Miyagi prefecture, photo by Kazuya Mitsuji)<sup>1)</sup>

Figure 2. Shear failure of pile foundation at a cut and fill boundary (Yamakoshi-mura, Niigata prefecture)

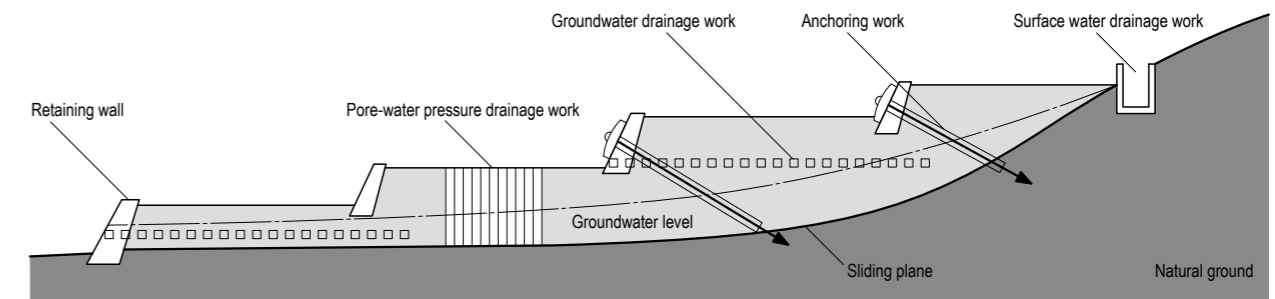

Figure 3. Image of earthquake-proof conversion of large-scale developed land<sup>2)</sup>

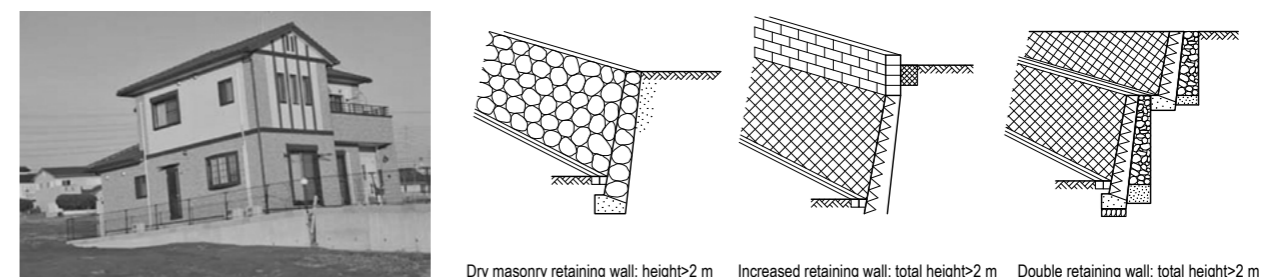

Figure 4. Inclination of a house caused by subsidence of land reclaimed from the sea (Fukashiba district of Kamisu City, Ibaraki prefecture, photo by Koji Tokimatsu)<sup>1)</sup>

Figure 5. Illegal retaining walls with very low earthquake resistance<sup>3)</sup>

## 2-6 Addition to seismic force in structural calculations

The maximum intensity of seismic motion may be estimated by evaluating the given recurrence interval and generating mechanism of an earthquake. The relative representation of such an expectation value by region is called a zoning factor. It should be noted that the effect of local topography is not considered here.

### Seismic hazard

The basic indicator for defining a building's seismic load is the magnitude of seismic motion which is thought might occur at the building's location. Earthquakes occur due to fault activity at the inner-plate or plate-interface crust. The seismic motion propagates to the bedrock and then to the ground surface under the building. A part of the seismic motion becomes the building's seismic load. Therefore, it would be highly useful if the seismic hazard (seismic risk) at the building's location could be predicted. However, it is not possible to definitively determine the risk because of a high degree of uncertainty. Seismic hazard stochastically represents the magnitude of seismic motion which may occur due to an earthquake at the ground or deeper seismic bedrock, and the maximum acceleration or maximum velocity which will occur within a given recurrence interval is used in the calculation (Figure 1). The "Kawasumi map" (1951) was an early study of seismic hazard, after which a number of methods have been developed including research using an earthquake catalogue which is a compilation of seismic focus data of previous earthquakes, and research based on earthquake mechanisms at plate-interfaces or active faults.

### How to define the zoning factor

The zoning factor of an earthquake is basically consistent with seismic hazard (Figure 2). It defines the expected value of the maximum seismic motion which will occur within a given recurrence interval by region with a relative valuation, and was established in consistency with the former Building Standard Law of Japan and based on administrative decision making. Moreover, because it deals with a wide region, specific conditions of narrower areas are not considered. Looking at a seismic hazard map, the values are greater at the Pacific Ocean side because of subduction-zone earthquakes at plate-interfaces. On the other side, the values are smaller on the inland side, and they are even smaller at the Sea of Japan side. However, it should be noted that an inland earthquake may cause great seismic motion locally even if its magnitude is small, because in most cases such an earthquake would occur directly underneath with a shallow focus at an active fault.

### Value of the zoning factor

Seismic zoning factor ( $Z$ ) defined in the existing Building Standard Law of Japan and Enforcement Order directly affects the story shear force for calculating the seismic load to buildings.

The story shear coefficient is calculated by the following formula.

$$C_i = Z \cdot R_i \cdot A_i \cdot C_0$$

$C_i$ : shear coefficient of layer  $i$

$R_i$ : vibration characteristic coefficient

$A_i$ : vertical distribution coefficient

$C_0$ : standard shear coefficient

It is a characteristic of the zoning factor  $Z$  that its value is given with no relation to either building or ground characteristics. The zoning factor is a reduction coefficient in accordance with the probability of the non-occurrence of an earthquake and its value ranges from 1.0 to 0.7. Even so, local governments are independently reviewing and setting zoning factors. For example, Shizuoka prefecture adopted a zoning factor of 1.2 in principle, because the possibility of Tokai earthquakes in the near future are of great concern. Fukuoka City ( $Z=0.8$ ) has set a guiding zoning factor of 1.0 (1.25 times of original value) depending on the area because the Fukuoka Earthquake occurred in 2005 (seismic intensity was 6 in Fukuoka City).

### Setting a seismic motion level

Earthquakes have occurred at those locations where the zoning factor is smaller, such as the 2000 Tottori Earthquake, 2001 Geiyo Earthquake, 2004 Chuetsu Earthquake, 2005 Fukuoka Earthquake, and the 2007 Chuetsu Offshore Earthquake all of which caused great seismic motions. Under the existing Building Standard Law of Japan and Enforcement Order, the extent of amplification of seismic motion caused by local topography or the scale of an active fault is not considered for the seismic motion level (seismic design load). Therefore, seismic motion may be under estimated even within one zoning factor area or in a lower zoning factor area.

In the earthquake-resistant design of buildings, the intensity of seismic motion should be set at the start. For this, the above-mentioned seismic hazard is used. For reference, the "National Seismic Hazard Maps for Japan" is published by the government established Headquarters of Earthquake Research Promotion, and seismic motions based on any specific focus faults and Probabilistic Seismic Hazard Maps have been compiled (Figure 3). Their research results are disclosed at the "Japan Seismic Hazard Information Station (J-SHIS)," a disclosure system of the National Research Institute for Earth Science and Disaster Prevention. Regarding the amplification characteristics of the ground, a "geotechnical engineering map," which describes an outline of the soil structure of each area has been prepared by the prefectures. After evaluating these references, an increase to the seismic load will be made. Although at present the usual earthquake-resistant design does not require using these references, it is desirable to popularize these methods in order to achieve a more rational design of buildings.

(Mitsugu Asano)

□ Sources of figures

1) Edited by the Architectural Institute of Japan, Seismic Loading -State of the Art and Future Development, 1987

2) Website of the Japan Seismic Hazard Information Station (J-SHIS), National Research Institute for Earth Science and Disaster Prevention <http://www.j-shis.bosai.go.jp/maps-pshim-prob-t30i55>

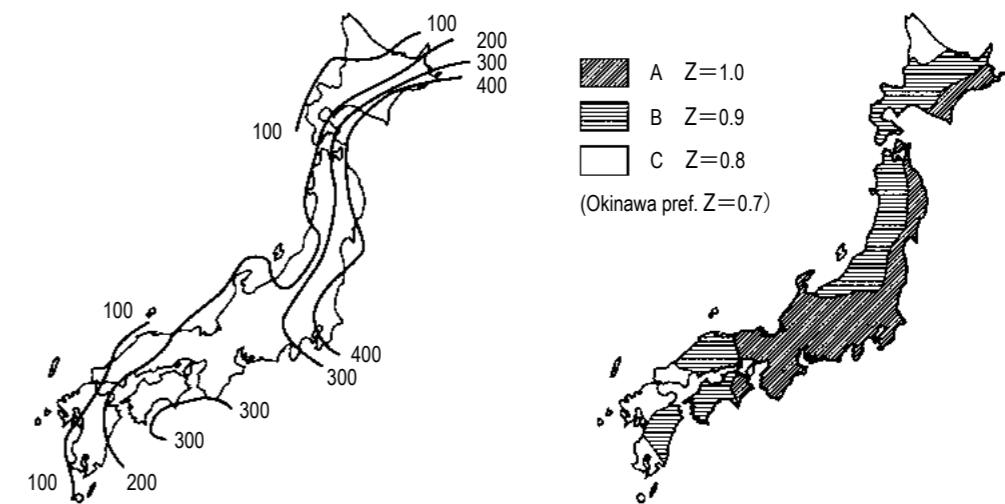

Figure 1. Value associated with return period of 100 years for acceleration<sup>1)</sup>

Figure 2. Seismic zoning factor defined in the Building Standard Law of Japan<sup>1)</sup>

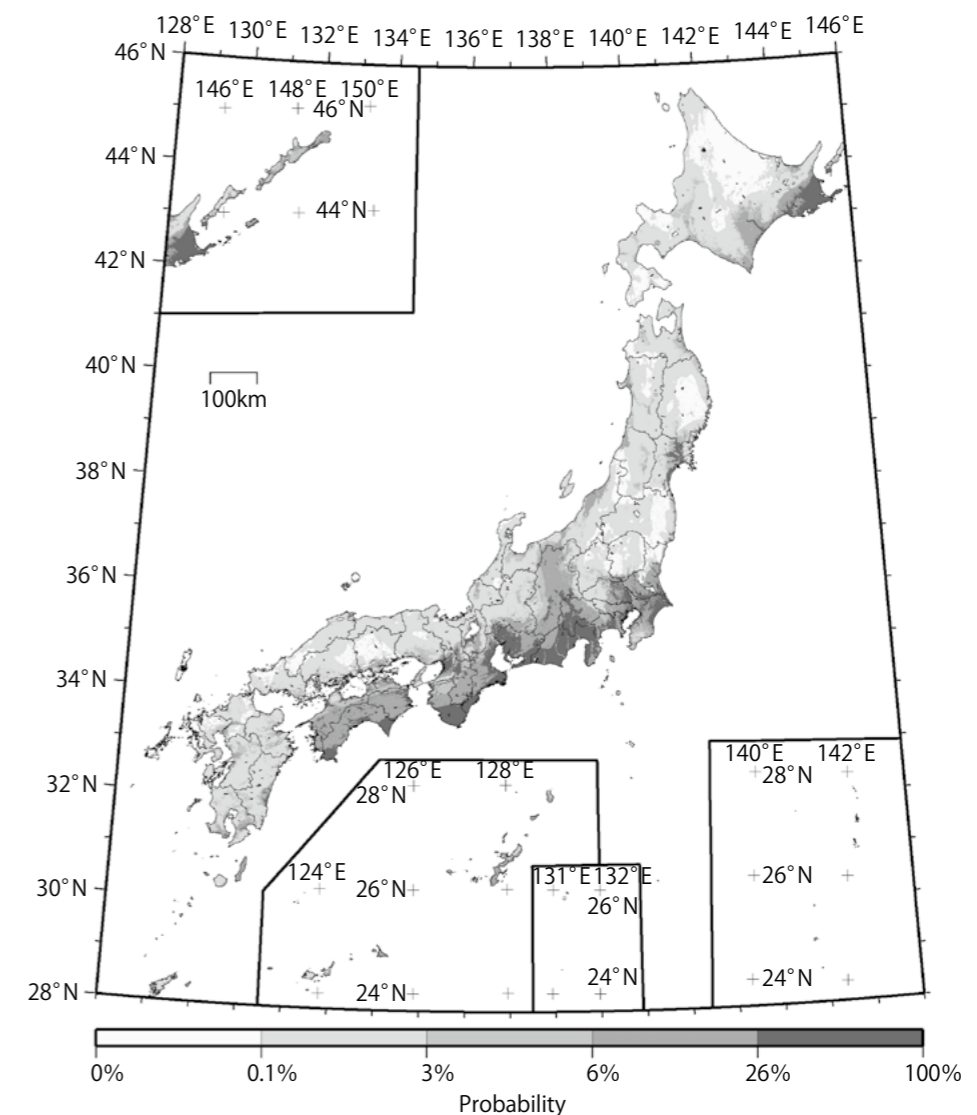

Figure 3. Probability of an earthquake with a seismic intensity of 6 or more over the next 30 years<sup>2)</sup>

## 2-7 Soil investigation as the basis of design

Implementation of soil investigation forms the basis of design, and it is desirable for architects to understand its general outline and purpose. In addition, architects need to acknowledge that the first step for architectural design is to draw up effective investigation plans and be involved in their thorough implementation in cooperation with structural engineers.

### Necessity of architect's involvement in soil investigation

Paragraph 1 of Notice No. 1113 of Building Standard Law of Japan specifies the method of soil investigation required for foundation design. Implementation of soil investigation is required not only for structural design but also stipulated by law. Therefore, any architect, who plays a leading role in discussions with clients, should understand the general outline and purpose of soil investigation.

An architect must conduct a site survey at the time of starting to design, and thoroughly understand the overall site situation including topographic features, surroundings, and neighboring buildings. The first step for architectural design is to draw up effective investigation plans and in cooperation with structural engineers be involved in their thorough implementation for the purpose of collecting all information about the ground and the site required for the architectural design and construction scheme.

### Basics of investigation items

Soil investigation items should be selected in accordance with ground conditions, structural requirements for the assumed building, etc. Basics are as follows.

1. In order to understand the ground composition, carry out a bore survey to obtain in-situ test soil samples.
2. Implement a standard penetration test and obtain a geological columnar section which shows distribution of "N-values."
3. In the cases of a sandy layer or sandy gravel layer, the bearing capacity of the ground is calculated by using N-values. On the other hand, in the case of a clay/silt layer, obtain an "undisturbed sample" and implement mechanical tests, such as a "uniaxial compression test" as an "indoor soil test" to find the shear strength of the ground.

Table 1 is an example of the specification of soil investigation used for the design of a seismically isolated building built on liquefiable ground. By using this table, the investigation items necessary for the evaluation of the earthquake resistance of the ground and foundations as well as the input seismic motion to buildings are explained as below.

### Investigation items necessary for the examination of liquefaction

Figure 1 shows the outline of a simple assessment method for the liquefaction potential of an area of ground. This method, which is commonly used in construction work, is called the FL method, and the liquefaction potential is evaluated by a FL-value, having as a denominator the shear strength which occurs within the sandy layer due to an earthquake, and as a numerator the liquefaction resisting force of the ground. When the FL-value is lower than 1.0, the ground is assessed as having liquefaction potential.

Roughly speaking, it is assumed that the subject of inves-

tigation is a loose alluvial sandy layer below groundwater level, and the depth investigated is from the ground surface to 20 m below the surface. Items required for soil investigation include the standard penetration test to evaluate the resisting force of the ground, as well as the test to calculate the percentage of clay/silt content (fine grain fraction) and the unit weight of soil. These are shown in the "Collection of disturbed sample" column of Table 1 as "Soil particle density test" and "Particle size test." Figure 2 is an example of a table for simple assessment of the liquefaction potential. It shows three items of safety factors (items of FL-value: , , and ). The examination of liquefaction requires an assumption of the maximum acceleration of seismic motion, and in this example, three levels at 200 gal, 250 gal, and 500 gal are assumed. However, maximum acceleration of 200 gal for a medium earthquake, and 350 gal for a great earthquake are usually used. The groundwater level is high (about GL-1.7 m), and the N-value is continuously about 10. Therefore, this is typical liquefiable ground.

### Earthquake resistance examination of filling and retaining walls

To evaluate slope failure due to seismic motion and an increase of earth pressure on a retaining wall during an earthquake, the "shear strength" as a strength parameter in addition to the unit weight of the soil are required. It is estimated using the "N-value" from the standard penetration test in the case of sandy ground. On the other hand, in the case of clay/silt ground, the above-mentioned "mechanical test" by obtaining an "undisturbed sample" is needed.

### Investigation items necessary for the evaluation of input seismic motion

In many cases, input seismic motion to buildings is amplified by ground vibration. Vibration analysis of high-rise buildings and base-isolated buildings as well as the seismic calculation route, such as the limit strength calculation, require to know the extent of such amplification and the specific period to which each soil layer is prone to quake (natural period of ground).

"PS logging," whose test method is shown in Figure 3, is a test to measure the propagation velocity of any oscillatory wave which propagates in soil layers by generating a longitudinal wave (stretching wave, P wave) and transverse wave (shear wave, S wave) on site.

Figure 4 is a result of PS logging. It shows that the value of waves changes at each soil layer. During an earthquake transverse waves affect buildings more greatly than longitudinal waves. The natural period of the ground's transverse vibration is calculated by using the S wave velocity.

On the other hand, Figure 5 is a result of "microtremor measurement," which is an in-situ test for estimating vibration characteristics of the ground including the natural period, by measuring microtremors of the ground and conducting a spectral analysis.

□ Sources of figures

- 1) Yoshiaki Yoshimi, Suna jiban no ekijoka (Liquefaction of sand ground): second edition, Gihodo Shuppan, 1991
- 2) Edited by the Architectural Institute of Japan, Recommendation Procedures for Planning Soil Investigations for Design of Building Foundations, 2009

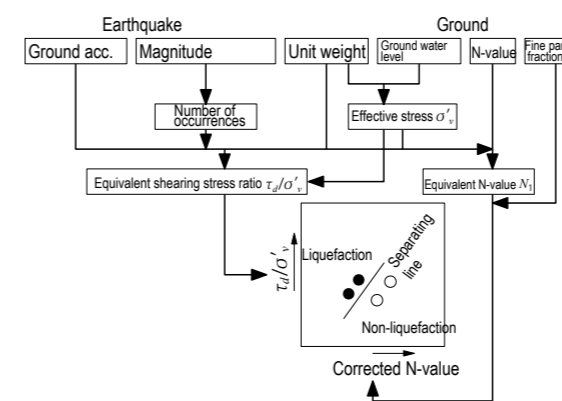

Figure 1. Outline of the method for simple assessment of liquefaction potential<sup>1)</sup>

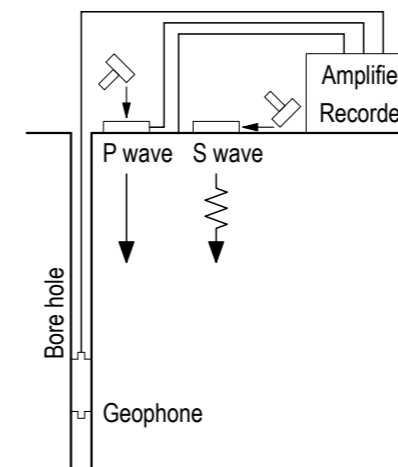

Figure 3. Example of test method for PS logging<sup>2)</sup>

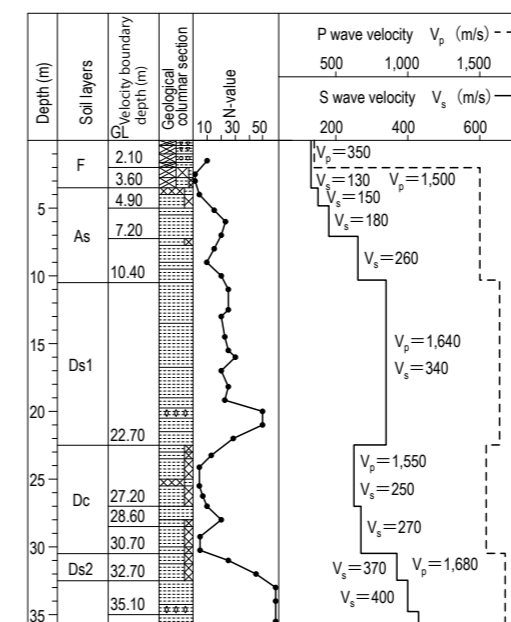

Figure 4. Display example of PS logging result

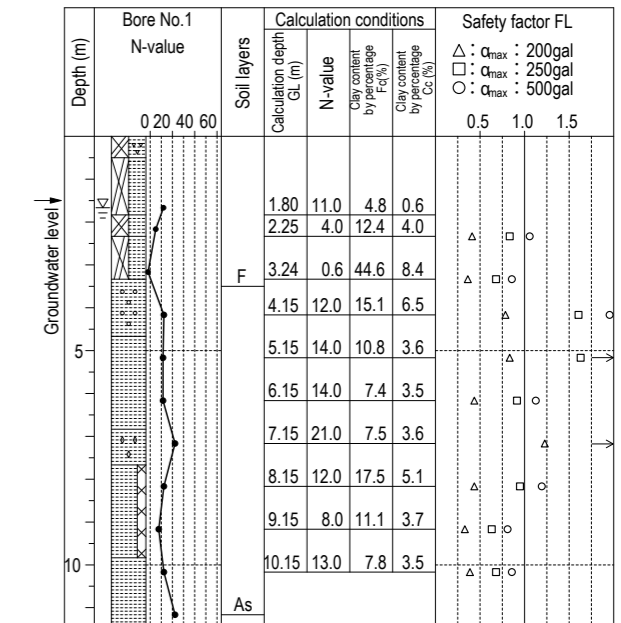

Figure 2. Example of table for simple assessment of liquefaction potential

Item	Bore depth (m)	66		86		116		Total					
		Num.	Total length	N-value Points	Num.	Total length	N-value Points	Num.	Total length	N-value Points			
Boring and standard penetration test	No.1				1	70	70			1	70	70	
	No.2	1	8	8				1	42	37	1	50	45
	No.3	1	40	40	1	10	10				1	50	50
	No.4	1	50	50								1	50
	m												
total		3	98	98	2	80	80	1	42	37	4	220	215
Collection of disturbed sample (points)	No.1, No.4 Soil particle density test and particle size test, to a depth of GL-20 m, at every 1 m										20		
Collection of undisturbed sample (points)	Thin-wall sample										5		
	Triple sample										5		
Microtremor judgment	3 components, 2 points on ground surface, 3 points underground Measurement with 1 second seismograph. For ground surface, long-period seismograph for more than 5 seconds.												
Artesian pressure measurement													
Borehole loading test											2		
PS logging	To a depth of GL-70 m, at every 1 m										70		
Dynamic triaxial test	4 points										4		

Table 1. Example of descriptions of soil investigation specifications

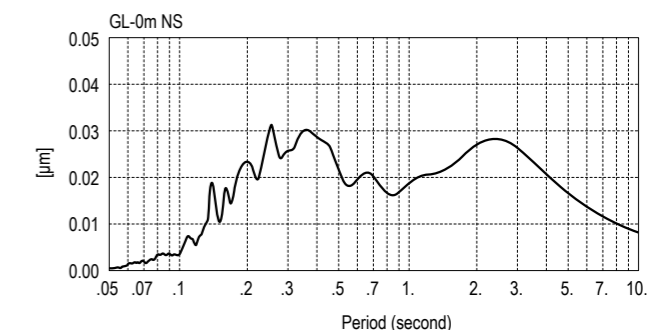

Figure 5. Example of Fourier spectrum as the result of microtremor measurement

### 3 Damage from Tsunami

#### 3-1 Cause and type of tsunami

When oceanic plates are subject to subduction, the edge of the terrestrial plate is dragged by the oceanic plate and is subducted, while the bending part of the terrestrial plate is subject to upheaval. The part with asperity slides, and the terrestrial plate slides in conjunction, before snapping back into shape. At that moment, the edge of the terrestrial plate in the sea is subject to upheaval and a tsunami occurs, while the upheaved part is subducted.

##### Interplate earthquake

When an oceanic plate is subducted, it drags the terrestrial plate and then its edge is subducted. When frictional stress reaches a limit at an adhered part (asperity), the terrestrial plate suddenly slides and a great earthquake with about M8 occurs, as the plate snaps back into shape.

At that time, the edge of the terrestrial plate is lifted up and snaps back into shape. This upheaval of the seafloor raises the sea water above and generates a tsunami (Figure 1). This location is called the source area of a tsunami. Until the whole plate returns to its original shape, repeated aftershocks occur, until the ground gradually stabilizes.

When residual frictional stress is great, a broad section of interplate slides in conjunction with the slide of an area with asperity, and a giant earthquake of about M9 occurs, it then becomes a state with low frictional stress (Figure 2 and Figure 3).

##### Height and velocity of tsunami

Though the height of a tsunami is 2 to 3 m in the ocean, the change in sea level appears as very small because the wave length can exceed 100 km. Frequently fishermen on boats offshore do not notice the wave, and when they return to their home port they have found massive devastation and everything washed away. In Japanese, tsunami means "wave at port."

Out on the ocean with a depth of 4 km, the velocity of a tsunami can reach 720 km per hour; by the time it nears the coast with a depth of 10 m it has slowed to 46 km per hour with a wave height of 6 m.

##### Ordinary waves and tsunami waves

Just as sound waves do not mix, each sea wave travels independently and keeps its own waveform, with no mixing. The wave period relates to the wavelength, for example with a period of 10 seconds, the wavelength is 156 m. Under these conditions, seawater measured from the surface to the depth of a half wavelength moves. In this example with a wave period of 10 seconds, half a wavelength of 156 m gives about 80 m, meaning seawater deeper than about 80 m does not move.

On the other hand, when the wave period of a tsunami is tens of kilometers, and the depth of the ocean is only about 4 km, then, seawater ranging from the surface to the seafloor as a whole moves horizontally a few hundred meters back and forth. It throws up sand and mud deposited on the seafloor and rushes to shore.

##### Types of tsunami

Some earthquakes generate a tsunami without generating a strong motion; this happens when a wide part of a plate slides slowly with no relation to asperity. They are known

as tsunami earthquakes. Earthquakes known as slow earthquakes do not generate seismic motion or a tsunami because a plate slides more slowly.

When the distance from the shore to the epicenter is 600 km or less, the tsunami caused by the earthquake is referred to as a tsunami of near-by origin, and when the distance is more than 600 km, a tsunami of distant origin.

When the height of a tsunami exceeds 2 m, damage increases sharply, and such a tsunami is known as a great tsunami.

##### Tsunami region

The Sanriku coast is a region of East Japan which frequently suffers tsunamis not only because its deeply indented coastline amplifies tsunamis but also because the Japan Trench off the coast has a submarine topography that leads to the concentration of tsunamis.

In this region, since a tsunami slowly damps and reaches a considerable distance, the Sanriku coast suffered a tsunami due to the 1700 Cascadia Earthquake which occurred off the coast of Seattle, as well as a tsunami resulting from the 1960 Chilean Earthquake (Table 1). The tsunami from the Chilean Earthquake took 22.5 hours to travel 17,000 km across the ocean.

Historically, however, West Japan has been more affected by tsunamis. The characteristic of tsunamis of this region is its occurrence immediately after an earthquake.

##### Meiji-Sanriku Tsunami

In 1896, a giant earthquake with M8.5 occurred. Mild quakes with seismic intensity of 2 to 3 lasted for about 5 minutes, and caused no damage. However, about 30 minutes after the earthquake, a huge tsunami with a height of 20 m hit the region and caused 22,000 deaths. This was a classic tsunami earthquake. A maximum runup height of 38.2 m was recorded at Ryori (present Ofunato City). At Taro-mura (present Miyako City), 83% of the residents were killed by the tsunami. After the disaster, changes of residence to higher places were implemented at 43 places. However, most residents returned within 10 years of the move because of the inconvenience of living on higher ground.

##### Showa-Sanriku Tsunami

In 1933, a giant earthquake with M8.1 occurred. It was a strong earthquake with seismic intensity of 5, but caused little damage. However, about 20 to 30 minutes after the earthquake, a giant tsunami with a height of 7 to 8 m hit the region, and caused 3,000 deaths. The tsunami was repeated about 6 times. Especially at Taro-mura, where 20% of the residents were killed by the tsunami, and 63% of houses were completely destroyed or washed away. Comparing with the Meiji-Sanriku Earthquake, the scale of the tsunami and the number of damaged houses were about 75%. On the other hand, the number of deaths was about 15% of the Meiji-Sanriku Earthquake. Observation and rapid evacuation by making use of the experience of 37 years earlier probably contributed to the lower number of deaths.

(Toshio Okoshi)

□Sources of figures

1) Based on the website of the Earthquake Research Institute, the University of Tokyo, Generating mechanism of tsunami <http://outreach.eri.u-tokyo.ac.jp/charade/tsunami/mechanism/>

- 2) Based on Fumio Yamashita, Tsunami tendenko, Shinnihon Shuppansha, 2008
- 3) Website of the Japan Agency for Marine-Earth Science and Technology, Press release on April 28, 2011 [http://www.jamstec.go.jp/j/kids/press\\_release/20110428/](http://www.jamstec.go.jp/j/kids/press_release/20110428/)
- 4) National Institute for Land and Infrastructure Management, Building Research Institute, Quick Report of The Field Survey and Research on "the 2011 off the Pacific coast of Tohoku Earthquake," May 2011

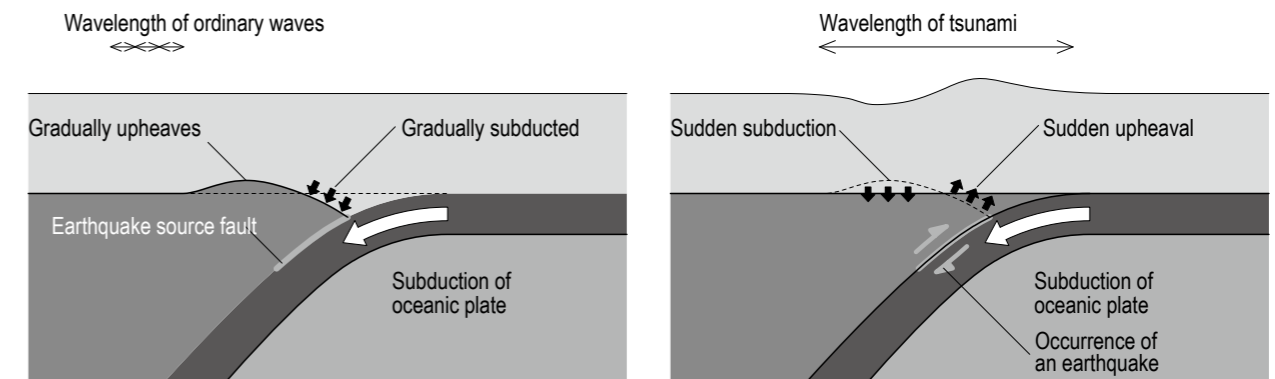

Figure 1. Occurrence of earthquake and tsunami due to subduction of the plate<sup>1)</sup>

Year	Name of earthquake	Magnitude	Runup height	Number of dead and missing
869	Jogan-Sanriku Earthquake and Tsunami	8.3		1,000
1611	Keicho-Sanriku Tsunami	8.1		5,000
1677	Enpo-Sanriku Tsunami	7.5		
1700	Cascadia Earthquake and Tsunami	9		
1763	Horeki-Sanriku Tsunami	7.4		
1856	Ansei-Sanriku Tsunami	7.5	6.0 m	
1896	Meiji-Sanriku Tsunami	8.5	38.2 m	21,959
1933	Showa-Sanriku Tsunami	8.1	28.7 m	3,064
1960	Chilean Earthquake and Tsunami	9.5	4.9 m	139
2011	Tohoku Earthquake and Tsunami	9	40.4 m	20,381

Table 1. History of tsunamis that have occurred on the Sanriku coast<sup>2)</sup>

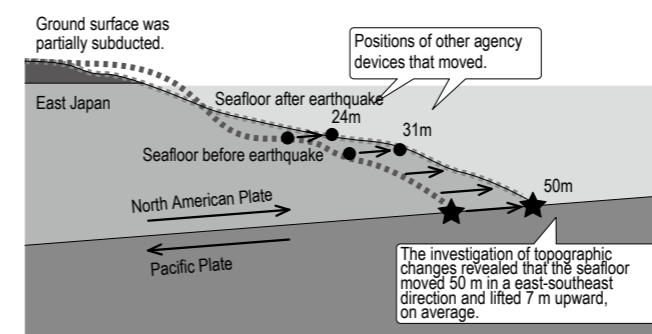

Figure 2. Movement of the North American Plate at the time of the Tohoku Earthquake<sup>3)</sup>

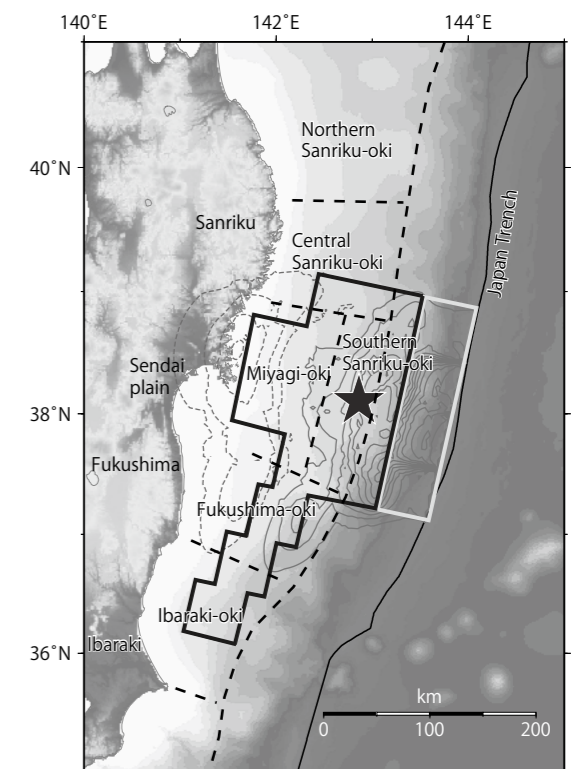

Figure 3. Seafloor crustal deformation calculated from the Tohoku Earthquake. Solid line shows the upheaval part (contour interval: 1 m), dashed line shows the subducted part (contour interval: 0.5 m), the area with a black border shows the source area of the first tsunami, and the area with a white border shows the source area of the second tsunami.<sup>4)</sup>

### 3-2 Force of tsunami

Tsunami force is calculated, in the same way as wind pressure, from the Navier-Stokes equation, but is 1,000 times greater than wind pressure. It is calculated with an assumption that its velocity is constant regardless of the depth. Tsunami force depends on velocity. The horizontal strength of a building is decreased by buoyancy. Floating wreckage acts in the same way as a missile or projectile and smashes into buildings and destroys them.

#### Inundation height and velocity

When a tsunami hits the shore, two different heights are distinguished: the height above sea level is called the runup height, and the height above ground level is called the inundation height.

At the time of the 2011 Tohoku Earthquake, the velocity of the runup flow of the first tsunami wave at Onagawa-cho, Miyagi prefecture reached 6.3 m/s at an inundation height of 6 m, then reached a maximum inundation height of 15 m in 15 minutes, and the velocity of the returning flow accelerated by gravity reached 7.5 m/s (shooting flow) at an inundation height of 6 m.<sup>(1)</sup>

At the time of the 2004 Indian Ocean Tsunami, the flood velocity reportedly reached 4 m/s at an inundation height of 2 m, and 8 m/s at that of 10 m.

#### Tsunami force

Tsunami force is calculated, as in the case of wind pressure, by solving the Navier-Stokes equation. It is 1,000 times greater than wind pressure, and is calculated with an assumption that its velocity is constant regardless of the depth. Therefore, the degree of damage caused by a tsunami depends on its velocity rather than depth (Figure 1). A high-velocity tsunami is called a shooting flow, and when it hits obstacles high waves occur. Just as the wind pressure is lower at the leeward side of a building, the tsunami force is lower at the downstream side of a large building and damage to the building will also be less.

#### Floating wreckage and buoyancy

At the time of the 2011 Tohoku Earthquake tsunami, the amount of floating wreckage was far greater than the 2004 Indian Ocean Tsunami. Floating wreckage with a high velocity has great kinetic energy, if it collides with a building it acts as if it were a missile, and destroys it in moments. The amount of floating wreckage per victim reached 1,000 tons, and many of the victims suffered injuries.

Buoyancy due to a tsunami decreases the vertical stress and horizontal strength of a building, buoying it up, and causing it to break free and drift.

Windbreak forests and seawalls decrease the velocity of a tsunami and the tsunami force. However, even though such structures do decrease the damage to buildings, they do not greatly decrease the number of victims because they do not affect the height of the tsunami.

#### Seawalls

Despite the fact the Taro district of Miyako City, Iwate prefecture had a giant X-shaped seawall with a total length of 2,433 m and a height of 10 m, its town area suffered catastrophic damage and 4.5% of the district's residents died

(Figure 2).

At Fudai-mura of Iwate prefecture, due to the foresight of the mayor, Mr. Wada, a giant seawall with a height of 15.5 m, making it higher than the 15 m height of the Meiji-Sanriku Tsunami, and a length of 155 m had been built; this defense saved the village with no flooding or loss of life, and one person missing.

#### Tsunami damage to wooden buildings

At those places where a tsunami has hit with a height of 4 m or more, most wooden buildings are washed away or completely destroyed. On the other hand, at those places where a tsunami with a height of less than 2 m has hit, the survival rate of wooden buildings was close to 100%, with little structural damage (Figure 3). Wooden buildings do have a disadvantage because they are given greater buoyancy by the tsunami. However, as the standards for pulling resistance were enhanced in 2000 the pulling resistance of wooden buildings greatly differs depending on the year of construction. Three story buildings, which are more closely designed and supervised, had due bearing capacity, and damage seemed to be less.

Damage due to the missile effect of floating wreckage was devastating, regardless of the year of construction (Figure 4).

#### Tsunami damage to reinforced concrete buildings

The percentage of washed away or completely damaged two story buildings was about 50%, but that of three story buildings or higher was 28.6%.

Strong main shocks of the earthquake lasted for a long time, and liquefaction occurred. Then, they were hit by a giant tsunami 30 minutes after the earthquake. It is thought that the tsunami generated great buoyancy for closed spaces under floors and building frames, and building movement or overturning was due to buoyancy and tsunami force (Figure 5).

Damage of structural frames and exterior walls of recently built buildings was not great. However, the tsunami smashed through windows, and damage to the inside of buildings was commensurate with the velocity of the tsunami (Figure 6).

#### Tsunami damage to steel frame buildings

It was difficult to differentiate damage due to the tsunami from those due to the main shocks. However, buildings overturned or swept away due to story collapse or breaks of exposed column bases, and welded sections of square steel pipes were observed. Moreover, great residual deformations were noticeable even in the remaining buildings.

Both interior and exterior materials of steel frame buildings were broken or washed away in a wide area, and many buildings with only steel frames remained standing (Figure 7). In the case of buildings with heavy-duty exterior materials, the whole building was lifted up due to buoyancy and moved or overturned.

(Toshio Okoshi)

#### Reference

(1) Koshimura, flow regime and building damage caused by the tsunami that hit the Tohoku region (Japanese); briefing session for Great East Japan Earthquake held by Tohoku University 3 months later

#### Source of figure

1) The data including background map data of this figure obtained from the Denshikokudo Web System of the Geospatial Information Authority of Japan.

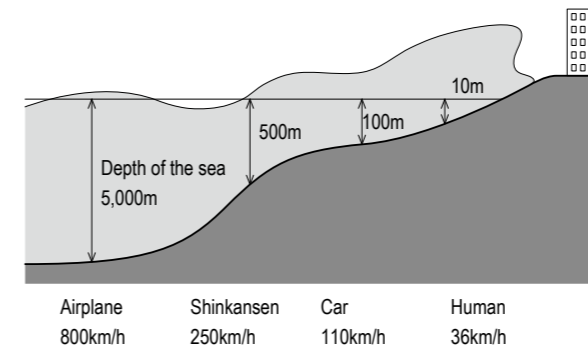

Figure 1. Velocity of tsunami



Figure 2. Flooded area and seawall of the Taro district of Miyako City, Iwate prefecture<sup>1)</sup>



Figure 3. The wooden houses in the old city area were completely destroyed, as were most of the remaining wooden houses in the new city area.



Figure 4. A mixed structure building with the ground first floor made with a reinforced concrete structure and the second and the third floors made with a wooden structure. Part of the second floor has been damaged by floating wreckage.



Figure 5. An old three story reinforced concrete building which was floated by the water, moved, and overturned, and a new reinforced concrete building with minor damage



Figure 6. Exterior wall of relatively new reinforced concrete building which was destroyed by floating wreckage



Figure 7. This steel-frame tough building is still standing, but the second floor has been destroyed.



### 3-3 Tsunami hazard map

It is widely known that seismic motion occurs from a focal region. With recently developed high density seismograph networks, it has been found that a tsunami also has a source area. An earthquake which occurs without a tsunami has only a focal region, and a tsunami earthquake has only a source area of the tsunami. Tsunami hazard maps are made based on the assumed source area of a tsunami.

#### Assumed source area of tsunami

Focal regions are assumed at plate boundaries. These boundaries usually slide independently, and great earthquakes of about M8 occur. The fracture velocity that causes strong motions is about 3 km/s. However, these assumed focal regions do not necessarily slide independently. In some cases a few regions slide in conjunction with each other, and a giant earthquake with about M9 occurs. Not all regions slide with the same velocity or have the same frictional stress (Figure 1 and Figure 2).

When sliding is slow and a number of regions slide in conjunction with each other, seismic motion is smaller and its period is longer. The edge of a plate spanning a wide region is dragged and snaps back into shape, and upheaves a tremendous volume of sea water, thus generating a giant tsunami. This is called a tsunami earthquake.

#### Tsunami height

At the time of the 2011 Tohoku Earthquake, sea level changes were recorded by the cable-type ocean-bottom seismometer located at offshore Kamaishi. Main shocks propagated to water-pressure gauges, and the sea level gradually rose at TM1. It first rose by about 2 m, and 11 minutes later suddenly rose by another 3 m or so, giving a total sea level rise of about 5 m. At TM2, which was positioned about 30 km landward from TM1, a similar sea level rise to TM1 with a delay of about 4 minutes was recorded (Figure 3).

#### Tsunami travel time

During the 2011 Tohoku Earthquake, the first wave arrived at the Sanriku coast about 10 to 20 minutes after the occurrence of the earthquake, followed by the arrival of the greatest wave. This greatest wave, looked similar to the first wave, but at such locations as the tip of a peninsula, cape, or island, waves of different timings and routes interfere with each other due to refractions, reflections, diffractions, etc. Therefore, the derivation of a tsunami becomes complicated, and some greatest waves are delayed, and others are damped very slowly.

A tsunami usually hits a coast, reflects there, and moves offshore. However, in the case of a long bowed beach, it generates refractions and reflections, and becomes an edge wave and lasts longer.<sup>(1)</sup>

#### Tsunami height at a coast

Tsunami height is inversely proportional to the fourth root of the sea depth and the square root of the waterway width. Therefore, a shallower sea does not necessarily make the tsunami height much higher. However, in the case of a bay, where the waterway is narrower, the tsunami height may become a lot higher. Where a tsunami arrives at the mouth of a bay with a sea depth of 160 m and a waterway width of 900 m, when

it reaches a point in the bay with a depth of 10 m and a width of 100 m, the tsunami height doubles due to a decrease of the depth, and coupled with a decrease of the width triples as well, giving a 6-fold total height increase.<sup>(1)</sup>

#### Runup height of tsunami

During the 2011 Tohoku Earthquake, the runup height of the tsunami was comparable with that of the 1896 Meiji-Sanriku Earthquake, but the tsunami hit a broader area (Figure 4).

A runup height of 40.4 m, the highest since observations began, was recorded at Aneyoshi district of Miyako City, Iwate prefecture. It was reported that, centering on the Sanriku coast, in an area measuring 198 km north to south the maximum height of the water mark exceeded 30 m, in an area 290 km north to south it exceeded 20 m, and in an area ranging 425 km it exceeded 10 m. In the Hokkaido and Kanto regions, the tsunami height was amplified near capes. <sup>(2)</sup>

#### Tsunami hazard map

Traditionally, tsunami hazard maps have been simulated from the assumed focal region of seismic motion, and disclosed by local governments. However, since the 2011 Tohoku Earthquake, tsunamis have been estimated from the assumed source area of a tsunami and have been reviewed. Tsunami hazard maps covering the country are available at the Tsunami Hazard Map in the Hazard Map Portal Site of the Ministry of Land, Infrastructure, Transport and Tourism.

#### Fire caused by tsunami and fire at industrial complexes

At the time of the 2011 Tohoku Earthquake, large-scale fires caused by the tsunami occurred at Kesennuma City and Ishinomaki City, both of which suffered great damage from the tsunami. Fires occurred at 131 places across three prefectures, and the total area destroyed by fire was 5,650,000 m<sup>2</sup>. Storage tanks had been placed on sand, resulting in their floating, and the fuel oil flowing out catching fire. Fires spread to ships, vehicles, and houses, and also into forests, and it took up to two weeks to regain control and put them out.

Fire at industrial complexes occurred at more than five locations including Tagajo and Sendai Cities of Miyagi prefecture, Ichihara City of Chiba prefecture, and Kawasaki City of Kanagawa prefecture. Fire in tanks occurred from damage caused by the sloshing of oil due to long-period seismic motions. <sup>(Toshio Okoshi)</sup>

#### References

- (1) Yoshiaki Kawata, Tsunami saigai (Tsunami hazard), Iwanami-shinsho, 2010
- (2) Research results of the 2011 Tohoku Earthquake Tsunami Joint Survey Group, April 26, 2012  
<http://www.coastal.jp/tjt/index.php?FrontPage>

#### Sources of figures

- 1) Website of the Central Disaster Management Council, Committee for technical investigation on countermeasures for the Trench-type Earthquakes in the Vicinity of the Japan and Chishima Trenches, handout of figures, 2006  
[http://www.bousai.go.jp/kaigirep/chuobou/senmon/nihonkaiko\\_chisimajishin/index.html](http://www.bousai.go.jp/kaigirep/chuobou/senmon/nihonkaiko_chisimajishin/index.html)
- 2) Website of the Central Disaster Management Council, Investigative commission on a great earthquake model of the Nankai trough, handout, 2011  
<http://www.bousai.go.jp/jishin/nankai/model/index.html>
- 3) Website of the Earthquake Research Institute, the University of Tokyo  
[http://outreach.eri.u-tokyo.ac.jp/eqvolc/201103\\_tohoku](http://outreach.eri.u-tokyo.ac.jp/eqvolc/201103_tohoku)
- 4) Yoshinobu Tsuji (Earthquake Research Institute, the University of Tokyo), Prof. B. H. Choi (Sungkyunkwan University), Dr. Kyeong Ok Kim (KORDI), Mr. Hyun Woo (Marin Info Tech Co), et al.

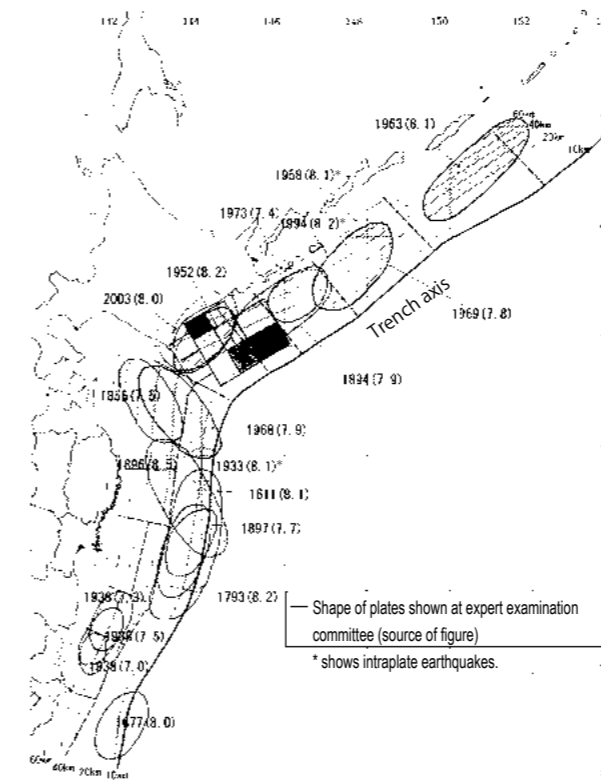

Figure 1. Distribution of source areas of tsunami along the Kuril Trench-Japan Trench<sup>(1)</sup>

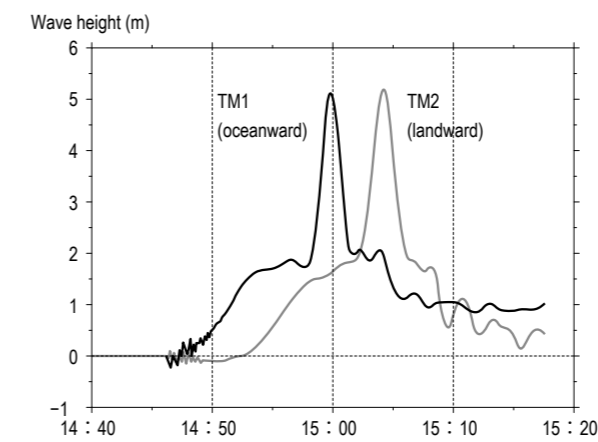

Figure 3. Sea level changes measured with water-pressure gauges<sup>(3)</sup>

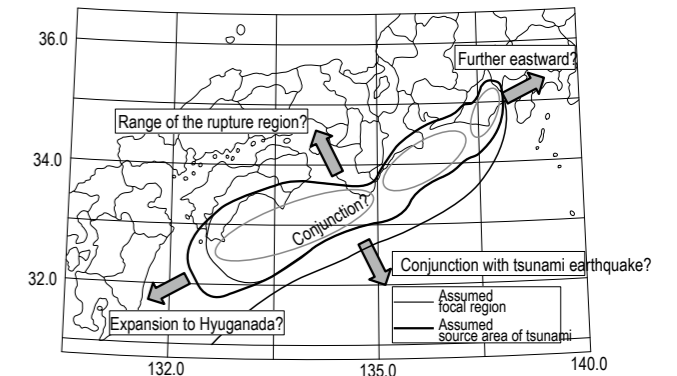

Figure 2. The assumed source area of tsunami at the Nankai Trough<sup>(2)</sup> Later, the source area of the tsunami was expanded to be twice as large as the focal region.

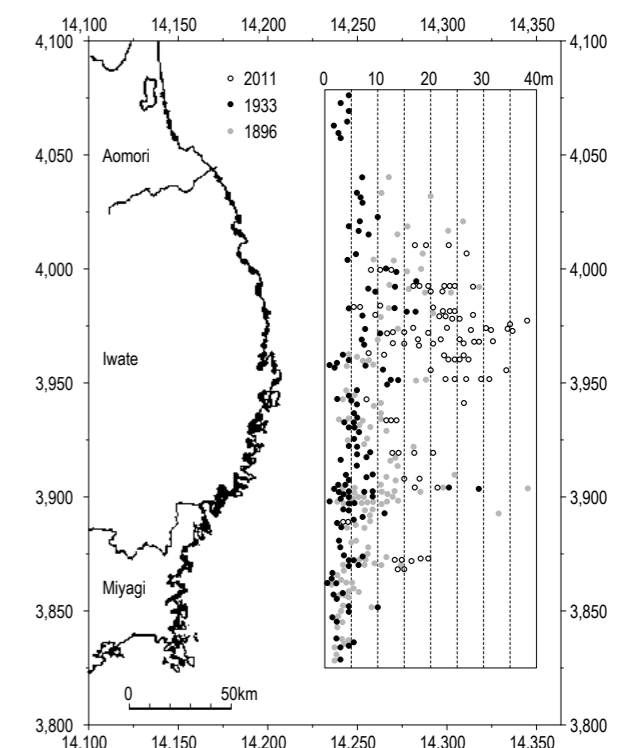

Figure 4. Runup height of tsunami<sup>(4)</sup>

### 3-4 Towns that withstood the tsunami

The national land of Japan has been developed by fighting against and coexisting with nature and disaster. However, this begs the question: are there any effective countermeasures against a 1-in-1,000 year disaster? The answer must be sought from now on, but it is quite sure that “multiple protection” including both hard and soft measures will be necessary.

#### Act on regional development in tsunami disaster came into force in December 2011

This law stipulates that the governors of prefectures should assess and set assumed areas of tsunami flooding, and local governments should prepare promotion plans for regional development taking into account the possibility of a tsunami disaster. Within an area for a promotion plan, projects including the “creation of a tsunami disaster prevention housing construction district,” “mitigation of floor area ratio for a tsunami refuge building,” “preparation of plans for promoting group relocation projects by prefecture,” and the “city planning of a group facility for forming a core town area” can be implemented. In addition, governors of prefectures or mayors must implement new construction, improvement, and maintenance of tsunami protection facilities. Moreover, governors of prefectures can designate a restricted area of tsunami disaster and a special restricted area of tsunami disaster to regulate development and building activities.

Other than legislation, we must put the lessons of the Great East Japan Earthquake to good use.

#### A town where a seawall helped

The seawall at the mouth of Kamaishi, Iwate prefecture, which had been the tallest seawall in the world with a height of 63 m, was destroyed by the tsunami. Rubble on the seafloor on the land side were washed and scoured away by the tsunami, and the wall blocks overturned and wrecked. However, it was noted that the wall did weaken the power of the tsunami, and thus delay the arrival of the tsunami at a town area by 6 minutes; it bought precious time for evacuation. Though the surface of a seawall is concrete, the inside is made of earth. At Taro-cho the newest seawall was destroyed. Firmer safety measures including reinforcing the land side or piling may be effective. However, until now the adoption of such measures has been decided based on cost effectiveness. It is now necessary to argue and draw on our hard won wisdom about how they should be built in the future (Figure 1). Obviously reliable civil engineering structures are desirable, but we should never be over confident in the safety they provide (Figure 2).

#### A town where residents could evacuate

All of the 570 students of the Kamaishi-higasi Junior High School and the Unosumai Elementary School in the Unosumai-cho district of Kamaishi City were able to evacuate with no incident. This was because they put the maxim of “Tsunami tendenko” to good use; basically the students immediately ran to shelter, and then onto a hill and teachers and staff did not make the children wait or try to hand them over to their parents. At these schools, disaster prevention training had been carried out on a regular basis, in cooperation with experts on tsunami evacuation including those from Gunma University.

An evacuation drill had been held once a year, and risk management against a disaster which was greater than assumed had been implemented.

#### A town which maintained its community

Babanakayama village in the Utatsu district of Minamis-anriku-cho, Miyagi prefecture, is a small fishing village with less than 100 families, and suffered catastrophic damage from the tsunami. 200 residents were isolated for two weeks. The residents evacuated to a meeting place and with community leaders collected food stocks, where they kept warm by burning scrap wood and survived the aftermath of the tsunami. Without waiting for slow public administration works, they asked for volunteers across the nation, set up meeting facilities and baths, and acquired fishing boats. In order to avoid the dispersion of residents, they decided on group relocation to the hills, and looked for potential locations by themselves. They also made roads. Their toughness did not bow before the aftermath of the tsunami. It is very likely this was because they had a strong community spirit.

#### A town which maintained government facilities

Kesennuma City suffered great damage from the tsunami. The city hall, which was on a hill in the Yokamachi district, did not suffer flooding except for the ground first floor. As a result, in the immediate aftermath of the earthquake, risk management staff kept transmitting information via Twitter from the parking area on the fourth floor. Switching from PC to cell-phone, from 14:55 to 22:37 until the battery ran down, the staff transmitted 62 tweets. The content of these tweets included warning of the tsunami, magnitude of the tsunami, occurrences of fire, and appeals for evacuation.

Whether the administration office, which should be a core of community at the time of disaster, remains functioning or not makes a great difference to the extent of damage. Immediately after an earthquake, the roles which administrative authorities should play are many, including giving evacuation orders, transmitting information about the fate of residents, arranging rescue, and providing receiving stations for support. Administrative authorities have to address not only maintaining government facilities including a seismic retrofit and equipment replacement but also ensuring safe site locations (Figure 3).

#### A town which maintained a hospital

Ishinomaki Red Cross Hospital is located inland and had several advantages to combat the effects of a tsunami. The hospital building had a seismically isolated structure, but best of all, the staff of the hospital including doctors and nurses were of a high caliber, and in addition, they had organized a system for disaster response. Emergency response teams with a leading role played by doctors were functioning immediately after the earthquake. While administrative authorities were still unable to know the disaster situation of the surrounding area, the doctors themselves went around the area, requisitioned goods and supplied them in cooperation with volunteers, and carried out medical activities. This was a kind of miracle that happened in a situation where many hospitals were unable to respond due to lack of any one of the following: a safe location, a safe building, or disaster trained staff (Figure 4).

#### A town which maintained a fish market

The building of Kesennuma-shi Uoichiba (fish market) was a steel frame structure, and the roof was an open space intended for evacuation in the event of a tsunami. Though the management office on the first floor was washed away by the tsunami, the structure remained sound enabling speedy restoration. Fish were landed and the market was soon reopened. Then, ice plants and packaging plants resumed operations. Industries revived, people returned and their lives restarted. In this way, key industrial facilities need to be buildings enabling speedy functional recovery. In addition, it is also necessary to prepare disaster prevention plans which can maintain the key industrial facilities of a town.

(Kazuo Adachi)

□Source of figure  
1) Nobuo Shuto, Tsunami kyodo to higai (Tsunami intensity and damage), Tsunami Engineering Laboratory report, No. 9, 1992

Tsunami intensity	0	1	2	3	4	5
Tsunami height (m)	1	2	4	8	16	32
Features	Gentle slope	Rising at coast	Offshore waterwalls Second wave breaks	Those with breaking waves at the tip increase	The first wave also causes a plunging breaker	
	Steep slope	Fast tide				
Sound				Continuous sound due to front breaking wave (sea roar, storm)		
				Loud sound due to plunging breaker (thunder, unrecognizable when distant)		
				Loud sound due to crashing against a cliff (distant thunder, blasting, audible from a distance)		
Wooden house	Partially destroyed	Completely destroyed				
Masonry house	Durable		n/a	Completely destroyed		
Steel, R/C building	Durable			n/a	Completely destroyed	
Fishing boat	Occurrence of damage		Damage ratio 50%	Damage ratio 100%		
Tide-water control forest	Slight damage Mitigate tsunami Block wreckage		Partial damage Block wreckage	Complete damage Ineffective		
Aquaculture	Occurrence of damage					
Coastal village	Occurrence of damage		Damage ratio 50%	Damage ratio 100%		
Runup height (m)	1	2	4	8	16	32

Note: The tsunami height (m) in the table means the height of the tsunami at the shoreline for floating objects on the sea including ships and rafts, and the inundation height measured from the ground surface for structures and items on the ground including houses and tide-water control forests. In the bottom row, the description for a village as a whole is given, and the relation between the maximum runup height (m) that occurred within the flooded area of the village and the degree of damage as a house damage ratio within the flooded area as a whole is indicated.

Figure 1. Tsunami height and degree of damage<sup>1)</sup>



Figure 2. Broken seawall at Taro-cho. The wall was overturned due to scouring at the base. In contrast, some seawalls and floodgates such as those at Fudai-mura, Iwate prefecture functioned with no damage.



Figure 3. Damaged government building at Otsubuchi-cho (Iwate prefecture). The tragic loss of the mayor and staff was a far greater loss than any building damage.



Figure 4. Shizugawa Public Hospital (Miyagi prefecture), which had finished a seismic retrofit, suffered from the tsunami which was much stronger than the Chilean Tsunami.

### 3-5 Buildings that withstood the tsunami

The purpose of earthquake disaster prevention has changed from simply saving life to now include the maintenance of functions. On the other hand, the purpose of tsunami disaster prevention has just focused on saving life, with evacuation being given the highest priority. However high a seawall is built and however strong a building is constructed, a tsunami greater than expected will come. Speedy evacuation to higher places is essential. Ensuring evacuation routes for the interior and exterior of buildings should be given serious consideration.

#### Countermeasures start from the selection of location

Tsunami damage varies greatly in the same area, with some buildings being saved from the tsunami by just a little difference in ground height. The Aneyoshi district of Miyako City, Iwate prefecture, prevented tsunami damage by following a somber warning, "Never build a house below this level," carved on a gravestone after the 1896 Meiji-Sanriku Tsunami. As importance factors are used in earthquake-resistant design, there should also be an importance factor for tsunami resistance, and the safety of important buildings must be ensured from the stage of location selection. Regarding houses, relocation to higher places after an earthquake is recommended. However, a system is needed that keeps people from building on the seashore in the decades after an earthquake, even if their memory of the disaster is fading. Important buildings such as administration offices, schools, hospitals, and police stations should not be built on reclaimed land etc. but on places free from flooding. Countermeasures by means of the design of the building's structure should be considered only after considering the location and finding little flat land, as in rias coastlines (Figure 1).

#### RC buildings withstood well, but they were not perfect

According to a report by the Ministry of Land, Infrastructure, Transport and Tourism on the buildings damaged by the Great East Japan Earthquake, in terms of percentage by construction method, wooden buildings accounted for 73% of damaged buildings, reinforced concrete buildings (RC buildings) 2%, steel frame buildings 5%, and others (light steel frame, storehouse with thick mortar walls, concrete block) 7%. As is clearly seen wooden buildings make up the great majority, and most of them were damaged by the tsunami. In the areas affected by the earthquake, only concrete continuous footings of wooden buildings remained. When the tsunami height exceeds 2 m, wooden buildings are partially damaged and begin to be washed away; in the case of steel frame buildings, ALC panels and wall finishes are washed away, and only the steel frame remained (Figure 2). Although most small-sectioned steel frames collapsed, large-sectioned steel frames were strong.

Most RC buildings remained standing. Buildings with pilotis suffered little damage even when the upper floors were flooded, they mitigated the effect of the powerful tsunami water. However, it should be noted that the seismic period of the Great East Japan Earthquake was not a killer pulse for buildings with pilotis. Although some RC buildings drifted at Onagawa-cho, it can be said that in general the weight and strength of RC buildings enabled them to withstand the tsu-

unami (Figure 3).

Regarding the remaining buildings, walls and openings were damaged. Many of them escaped complete collapse by allowing the tsunami water to flow through, not by resisting the tsunami. Some buildings suffered foundation damage due to scouring by back wash. At any rate, RC buildings performed well in those areas flooded by the tsunami. A number of buildings with floors higher than expected flood levels and usable for evacuation saved human lives.

#### Layout and protection of equipment is important

It is necessary for function maintenance and functional recovery to review the planning of equipment systems. Within the area flooding is expected, mechanical rooms and electronic rooms should be located above the expected flood level, not as is more common in the basement. A lot of the equipment positioned on roofs or penthouses could survive. It is possible to recover the functions of equipment in response to restoration of the infrastructure. Watertight division of pipe shafts, trunk lines of electricity, shafts, etc. is also necessary. Moreover, by raising the height of water tanks and cooling towers installed on the ground level and protecting them with fences, damage due to floating wreckage would decrease (Figure 4). At the time of the Great East Japan Earthquake, many fires caused by the tsunami were observed. One of the causes of these fires was outflow from propane gas cylinders. It is necessary to improve the storage and anchoring of such cylinders.

#### Forest surrounding a residence worked

In the Tohoku region, forest surrounding a residence is known as igune and protects a house against seasonal winds and solar radiation. In this case, igune also prevented houses from being washed away as well as from damage by floating wreckage. In addition to large-scale tide-water control forests along coasts, trees planted in building sites are effective against tsunamis. At facilities with large area such as schools and factories, it is desirable to plant rows of trees such as cedars to fulfill the double functions of CO2 reduction by greening and disaster prevention.

#### Roofs of tsunami refuge buildings are important; crime prevention and disaster prevention conflicts

A public housing building at the Shizugawa district of Minamisanriku-cho, Miyagi prefecture, which was designated as a tsunami refuge building, saved 50 people. This four-story RC building was behind and facing a seawall. The tsunami height exceeded 15 m and reached the roof. However, the roof had a sturdy stainless-steel balustrade with a height of 1.8 m. It saved the lives of people who were standing up to their chests in water (Figure 5). The door to the roof had a key and it was critical that the door was unlocked. Some people who evacuated to the roof of a hospital in the same district were killed by cold. Blankets and emergency supplies should be prepared in the penthouses of tsunami refuge buildings. In addition, a management system which automatically unlocks doors to roofs at the time of a disaster is necessary. Electrically managed security systems are becoming popular and it is becoming important for these systems to be able to unlock doors at the time of disasters. Controlling the floors at which elevators stop is a similar issue. There is a conflict between

daily crime prevention measures and disaster prevention.

In November 2011, technical recommendations on the structure of tsunami refuge buildings and the height of evacuation spaces were set forth by the Ministry of Land, Infrastructure, Transport and Tourism. They deal with considerations concerning tsunami load, overturning due to buoyancy, scouring by back wash, clashing with floating wreckage, etc.

#### Requirement for reusable structures is that they do not cause deaths

In stricken areas, the structure of many buildings suffered

no damage even if they were submerged in the water, but even so many of them will be demolished. After the Great Hanshin Earthquake, regrettably many buildings were demolished even though they were structurally sound. The reason for the demolition was largely due to a system that completely compensated the demolition costs if owners agreed to demolish within a certain period. However, the true reason was that owners or local people did not want to relive the memory of the dead and the injured, tragically reaffirming the essential requirement of any reusable building to enable safe evacuation and not be the cause of loss of life (Figure 6). (Kazuo Adachi)



Figure 1. Housing sites on sloping land. Just a few meters of difference means a great difference in damage.



Figure 2. The exterior finish of the steel frame building was washed away, and wreckage was trapped by the structure.



Figure 3. An overturned building in Onagawa-cho. The piles of a steel frame building with ALC panels were pulled out by buoyancy and side force of the tsunami, resulting in the building overturning and drifting.



Figure 4. Equipment protected by fencing. The equipment had been located on the ground, but the devices suffered no damage.



Figure 5. Balustrade on the roof of a building in the Shizugawa district served as a refuge from the tsunami. The sturdy balustrade with a height of 1.8 m saved the lives of 50 people.



Figure 6. A building marked as "Search Finished". Members of the Self-Defense Force and foreign assistance teams search for victims in buildings.

## 4 Required Performance Based Design

### 4-1 Formative design and everyday function vs. disaster prevention/earthquake resistant performance

The formative design of architecture used to be closely related to structure, but with the development of structural engineering it has gained considerably more freedom, although of course it still needs to be rational. We sometimes find incompatibility between everyday function and disaster prevention performance. Methods for designing modern high-rise buildings have developed to achieve a good balance between these two competing factors.

#### Formative design of architecture independent of structure was not possible

Formative design is an essential factor in the creative activities of architecture. In the past when the level of building technology was relatively simple, the formative design of architecture independent of structure was not possible. Many of the ubiquitous architectural spaces rooted in tradition are made possible by depending on structural systems which have been fostered in response to history and the needs and climate of a region. It is also well known that many of those buildings highly evaluated as great architecture have enhanced a basic structure to the level of formative art.

Such architecture includes the simple wooden structure form of the Ise Shrine with a raised floor and munamochi-bashira (ridge-supporting pillars) (Figure 1), the wooden frames of half-timber construction developed in Britain and northern Europe, and the masonry construction of Gothic cathedrals which appear to soar free of the weight of stone.

#### Modern architecture had based its formative design on structural form

The works of many modern great architects were inseparably related to the structural forms they pursued. Such works include the Domino system of Villa Savoye designed by Le Corbusier, the reinforced concrete cantilevered structure of Fallingwater designed by Frank Lloyd Wright, and the steel frames and metal works of the Seagram Building designed by Mies van der Rohe (Figure 2).

#### Relationship between the information function of architectural form and structure as a basis of architectural space is a great issue facing the creation of architecture today

Together with the increase of design freedom due to the increasing sophistication of building technology, the information function of architectural forms has advocated its own value. This was especially true of the postmodern designs that appeared in the 1980s; an eclectic and superficial architectural form borrowing its inspiration from earlier styles. It gradually weakened as a leading fashion after the bursting of the Japan bubble economy. However, in many countries including China and those in the Middle East, there is a great need to express meaning and advocate individuality through architectural forms.

Even in Japan, where earthquake resistant and disaster prevention performance are more strongly required after the Great Hanshin-Awaji Earthquake and the Great East Japan Earthquake, it is true that the development of structural engineering has greatly increased the freedom in exterior design. Today "No limits" design is cropping up all over Japan,

but in contrast, together with the increasing emphasis on environmental conservation and saving energy and resources of recent years, forms have become more and more dependent on environment-oriented facility planning. Architects need to design with humility, and understand that though their design freedom has increased, there is no technology that enables all they can imagine; in addition, a sense of balance is needed to fully grasp that forms lacking rationality will be abandoned with the passing of time.

#### Everyday function and disaster prevention/earthquake resistant performance are inseparable

As long as they are not disaster prevention bases or evacuation facilities, buildings are mainly designed in order to fulfill everyday functions. Fulfillment of everyday functions and disaster prevention/earthquake resistant performance are inseparable as the goal of architectural creation. A well-balanced configuration of seismic elements including bearing walls and braces, in addition to columns and beams, although effective for improving earthquake resistant performance, often reduce everyday ease-of-use. Furthermore, in most cases, everyday ease-of-use will change over time; and the impact of such contradictions are not negligible, as seen during a typical building rearrangement, for example, walls and columns often prove obstacles to new functions.

Safe evacuation from a fire requires an appropriate configuration of fire compartments and a safe and well-balanced arrangement of fire escape stairs, all of which often conflict with everyday ease-of-use.

Thus, it is not easy to ensure the compatibility between disaster prevention/earthquake resistant performance and the improvement of response capability with everyday ease-of-use and future changes in layout, etc. In order to ensure such compatibility, a variety of structural systems and planning methods for buildings have been developed. Especially when designing a building which will be used over the long term as a company's assets, it may be said that understanding the basic structures of timeless architectural spaces and creating such spaces is the greatest creative endeavor. Old Japanese style houses are a kind of wooden building megastructure and tend to live out their natural lives over generations. On the other hand, sukiya (tea ceremony room) architecture is intended to provide enjoyment of the special details of spaces assuming configurations in accordance with ease-of-use for the present moment.

#### Methods for designing high-rise buildings

Technology for constructing high-rise office buildings is highly symbolic within the framework of the above-mentioned meaning. Naturally the leading actor spotlighted "out front" who has enabled high-rise building was the development of structural engineering. However, the hidden supporting actor "out back" without whom no soaring skyscraper was possible was the development of the elevator technology, and the technology of non-structural elements, supplemented by environment-oriented facilities.

Against this background, rational architectural design methods for high-rise office buildings with simple repetition of a typical floor were devised. One of the most common methods is to combine a center core system and an outer envelope, based on core planning that utilizes vertically-stacked com-

mon use space including stairs, elevators, lavatories, shafts for facilities, and common corridors as seismic and wind-resistant elements. The separate core and open core systems are also well-established methods. These are the fruits of the tree of wisdom that have made everyday function and disaster prevention/earthquake resistant performance compatible (Figure 3, Figure 4).

(Narifumi Murao and Kazuo Adachi)



Figure 1. Shinmei-zukuri of Ise Shrine  
An architectural style with a raised floor and munamochi-bashira (ridge-supporting pillars) originated from a storehouse. Hafu (gables) supporting the roof penetrate and become chigi (forked roof finials).



Figure 2. Fallingwater (designed by F. L. Wright)  
Cantilever protruded above a fall strongly emphasizes the horizontal lines.

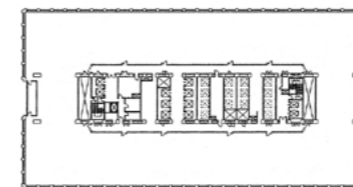

Figure 3. Typical floor of an office building with a center core system (Kasumigaseki Building, designed by Yamashita Sekkei)

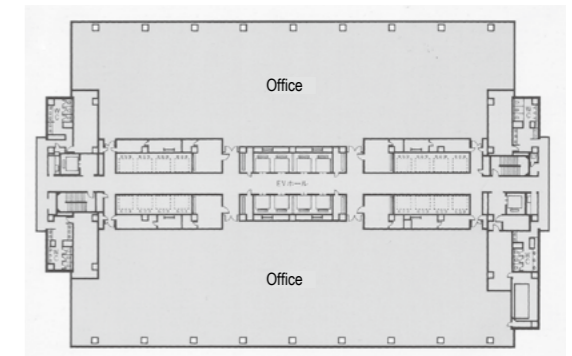

Figure 4. Typical floor of an office building with an open core system (Building B and C of Shinagawa Intercity, designed by Nihon Sekkei)

## 4-2 Transition of seismic design method

The seismic design method started with the enactment of the Building Standard Law of Japan in 1950. It was the allowable stress design method with a design seismic coefficient of 0.2. In 1981, a horizontal load-carrying capacity calculation method was added, and a two-stage design method was adopted. And in 1998, the performance-oriented design method was adopted, followed later by the addition of the limit strength calculation method and energy method.

### Rigid floor assumption and lumped mass model

In 1914, Toshikata Sano proposed the seismic coefficient method in his "Kaoku Taishin Kozo-ron (earthquake-resistant structure of buildings)." In the paper, the rigid floor assumption and lumped mass model were adopted. Since then, this assumption has been a key principle in Japan, and remains a unique method to Japan.

### Allowable stress design method

This method considers a safety factor from the strength of material, defines attenuation coefficients by engineering assessment, regulate the allowable stress of material, and ensures the safety and usability of structures. The plastic design method is desirable since the seismic force is so powerful. However, by using the allowable stress design method with a design seismic coefficient of 0.2, it was considered that the structure can resist a double to triple seismic force.

### Limit state design method

The European Committee for Concrete, established in 1953, developed the ultimate strength design method as an alternative to the allowable stress design method. This method carries out proportioning of section by multiplying the member stress from the elastic analysis of load combination and considering the load factor based on the probability of each load by the strength reduction factor of the member in consideration of the reliability of the strength of material, uncertainty of calculation formula, importance of member, etc.

The ultimate strength design method includes the load factor design method and the limit state design method. The limit state design method was proposed in 1964 by adding the structural regulation of the serviceability limit state and the durability limit state. Since then, it has become a standard design method. However, it is not intended to verify the performance of a designed frame or structure.

### Time history response analysis

Time history response analysis is intended to evaluate earthquake resistant performance by making a vibration model of a designed building, inputting seismic waves, and calculating the maximum ductility factor and maximum displacement response. The vibration model includes the lumped mass model which is unique to Japan and a model which directly uses a frame. For level 1, allowable stress design and a distortion angle of 1/200 or smaller is required, and for level 2, a story ductility factor of 2 or smaller and a distortion angle of 1/100 or smaller is required. There is no performance verification design method outside Japan.

### Horizontal load-carrying capacity calculation method

The Enforcement Order of the Building Standard Law of Japan was amended in 1980, and enforced in 1981. It included a two-stage verification method, consisting of an allowable stress calculation method as the first-stage and a horizontal load-carrying capacity calculation method as the second-stage.

Seismic force was now given as the story shear force, meaning the internal force at each story, instead of the external force by the seismic coefficient method (Figure 1). The standard shear coefficient is 0.2 or greater for the first-stage design, and 1.0 or greater for the second-stage design. The vibration characteristic coefficient indicates the response acceleration for the period of building according to the class of soil. The required horizontal load-carrying capacity is calculated by reduction with a structural characteristics factor according to ductility and by addition of a modulus of eccentricity and a story rigidity ratio. The horizontal load-carrying capacity is calculated by the load incremental method.

### Amendment of the Building Standard Law of Japan

The Building Standard Law of Japan was amended in 1998, and the performance-oriented design method was adopted (Figure 2). Deformation was defined and the degree of damage was calculated for the first time.

Seismic force was defined for the free engineering bed-rock surface, and evaluation of the amplification factor of surface subsoil became important (Figure 3).

### Limit strength calculation method

The limit strength calculation method was adopted in 2000. This is a response spectrum method which statically calculates the response value of the time history response analysis, and is a two-stage verification method with the damage limit strength and safety limit strength. The natural period and damping factor of a building change according to the degree of damage, and the deformation value is calculated (Figure 4).

### Notification of seismic isolation

Also in 1980, the technical standards for seismically isolated structures were established. This is a simplified calculation method equivalent to the limit strength calculation method. The shearing force that works on the building and the displacement of the seismically isolated layer are calculated by evaluating the seismically isolated layer with a bilinear characteristic, substituting the building by one mass system, and using the response spectrum of the ground surface.

### Seismic calculation method based on energy balance

The energy method was adopted in 2005. It is a method to evaluate the safety of a building with an energy-mediated response prediction of the building's seismic characteristics, and is a two-stage verification method with damage limit strength and safety limit strength.

(Toshio Okoshi)

□Reference

(1)Architectural Institute of Japan, Evaluation Procedures for Performance-Based Seismic Design of Buildings, 2009

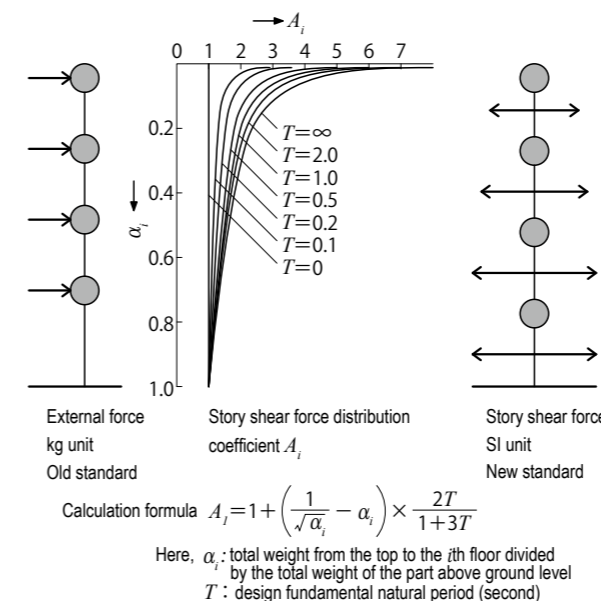

Figure 1. Seismic intensity load and story shear force

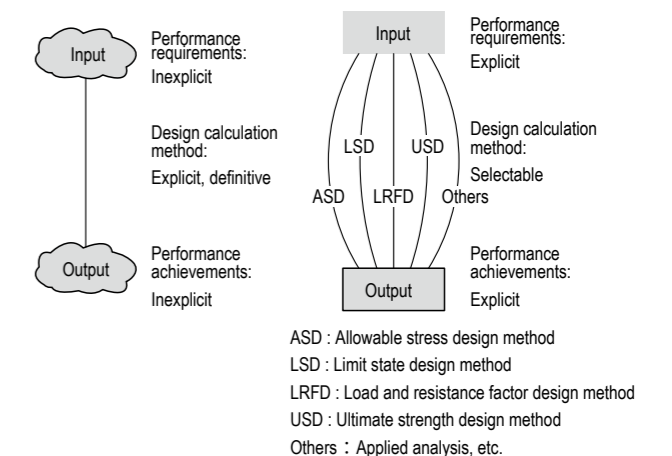

Figure 2. Performance-oriented design methods (by Hiroyuki Yamanouchi)

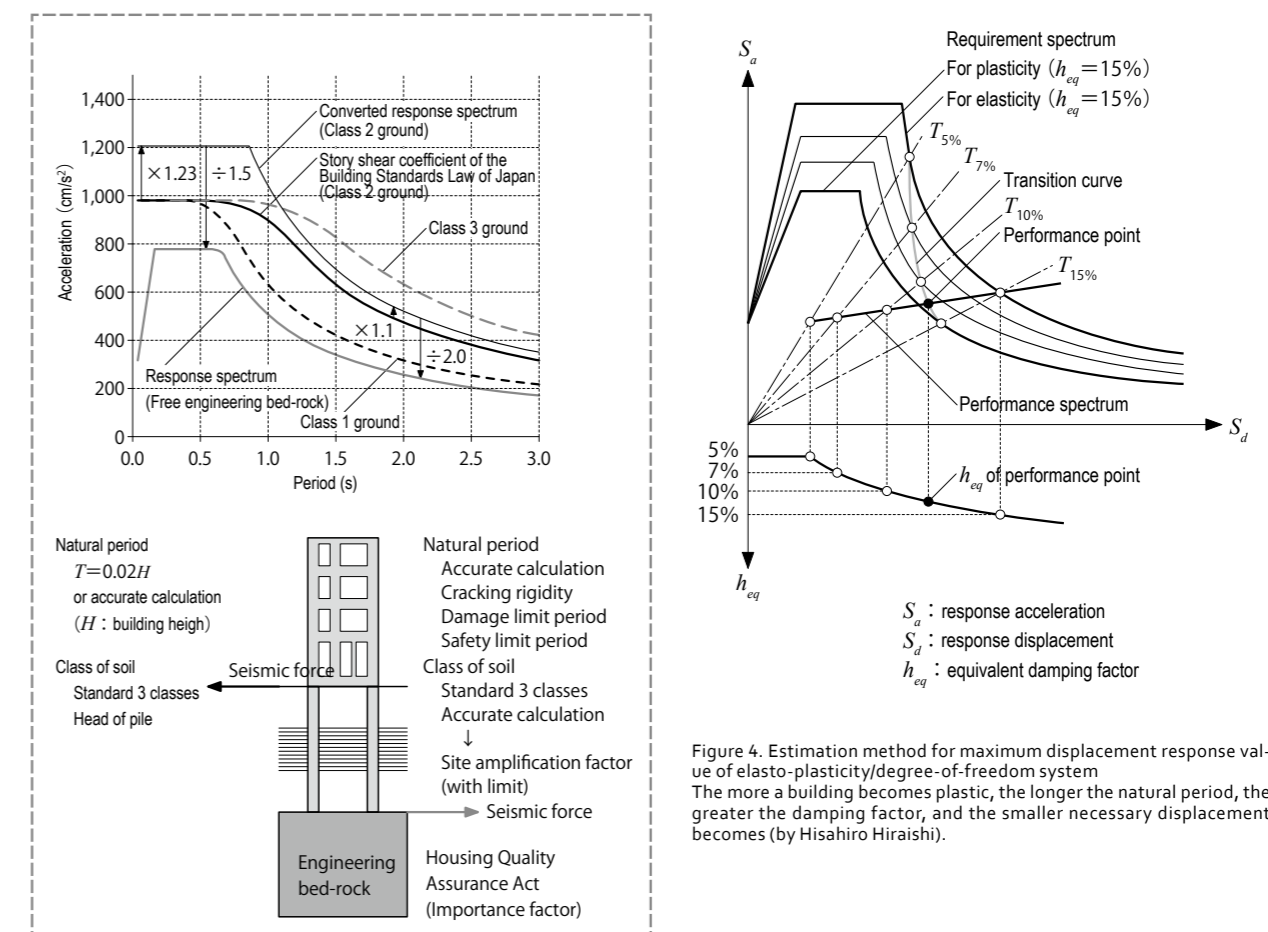

Figure 3. Seismic force at bed-rock and seismic force at ground surface

Figure 4. Estimation method for maximum displacement response value of elasto-plasticity/degree-of-freedom system. The more a building becomes plastic, the longer the natural period, the greater the damping factor, and the smaller necessary displacement becomes (by Hisahiro Hiraishi).

### 4-3 Earthquake-resistant design methods abroad

There are only a handful of countries where earthquake-resistant design methods are prescribed. In Latin America and Asia, they are rarely available, and there is no legal regulation or enforcement. Earthquake-resistant design methods abroad include the IBC of the United States of America, the IBC-equivalent standards of Taiwan, South Korea, and Indonesia, Euro Code 8 of Europe, and the China Standards made by amalgamating the standards of Japan and the United States of America. Here, the IBC is presented.

#### IBC 2003 (2003 International Building Code)

Earthquake-resistant design is prescribed in section 1613 through 1623, Chapter 16 "Structural Design" of IBC. This code is used as the model code by over 3,000 building codes all over the USA.

#### Structural planning

In the United States, the peripheral tube structure of a building bears the wind load and seismic load, and the frame inside is made with a pin-connected construction and does not bear lateral force, as demonstrated by the World Trade Center. Therefore, building standards prescribe the diaphragm in detail.

#### Strength

IBC prescribes that buildings, other structures and structural members should not exceed the appropriate strength limit state of construction materials, and should safely support factored loads at the time of combined loading. In the United States, the load and resistant factor design method is usually used for reinforced concrete construction, and the allowable stress design method is usually used for steel frame construction.<sup>(1)</sup>

#### Seismic importance factor

Buildings are classified into Category I to Category IV according to their use. The seismic importance factors of the Categories are, 1.00 for Category I and II, 1.25 for category III, and 1.50 for Category IV.

#### Seismic motion

Maximum considered earthquake ground motions that should be considered are shown in a map of the United States, for 0.2 second and 1.0 second spectrum response acceleration (5% of critical damping) at Site Class B. The design acceleration response spectrum is obtained by the following procedure. First, find the maximum earthquake ground motions for a short period of 0.2 second and a 1.0 second period at the site.

Then, multiply by the factors for the short period and 1 second period, according to the site class; they are amplification factors of the surface subsoil. Calculate the maximum considered earthquake spectral response accelerations, allowing 5% of critical damping and make spectrums based on them. These calculations are made by a geotechnical engineer (Figure 1).

#### Seismic load: criteria selection

Seismic design categories are defined as A to D based on response acceleration for a short period and 1 second period.

Buildings are classified into 6 categories for structural irreg-

ularity, and seismic design categories are defined as A to F for each plan and elevation (Table 1).

#### Minimum lateral force and related effects

Design load combination is called the load effect.

The seismic load effect from horizontal and vertical effects is a sum of the seismic load multiplied by a redundancy (overstrength) factor and dead load multiplied by a 20% short period design spectrum response acceleration.

The maximum seismic load effect is obtained by multiplying the design rate and factor for the basic earthquake-resistance—load—resistance system according to the structural forms classified into 78 categories. A redundancy factor of 1.0 is given to earthquake-resistant design categories A, B, and C, and a formula is given to category D. The minimum value of displacement and the story deformation angle is prescribed for each seismic use group of I to III.

#### Ductility of structural forms

The ductility of pure framed structures is 8 with a redundancy of 3. Therefore, eventually it is  $3/8=0.375$ , which is comparable with Japan's D value of 0.3. Its story ductility factor is 5.5. In the case of a bearing wall structure, it is  $2.5/5=0.5$ , which is comparable with Japan's D value of 0.55. Its story ductility factor is 5 (Figure 2).

#### Distribution of story shear force

The equivalent lateral force method in Section 9.5.5 of ASCE is used for the distribution of story shear force. The equivalent lateral force method is one mass approximate dynamic analysis, and the base shear and story shear force is shown by a formula from the seismic coefficient method with an inverted triangle.

In the case of the simple analysis method, the base shear and seismic coefficient distribution of the story lateral force is shown by an inverted triangle.

#### Seismic system

The basic seismic system includes 8 types, and is further divided into 78, each of which is given a response reduction factor (inverse of structural characteristics factor  $D_s$  of Japan), an overstrength factor, and an incremental displacement factor (it is estimated by elastic analysis because plastic analysis is not carried out), each of them is for use in designing. Limits of these factors and structural systems as well as height limits are shown in a table.

#### Dynamic analysis

Instead of the equivalent lateral force method, modal response spectrum analysis, linear time history analysis, and nonlinear time history analysis are allowed. Details are not prescribed.

#### Others

Other than those above, there are sections on component design and detailing, architectural, mechanical, and electrical component seismic design, non-structural element seismic design, seismically isolated structures, and their requirements are prescribed. Details are not prescribed. (Toshio Okoshi)

□Reference

(1)Bozorgnia and Bertero, Earthquake Engineering, ICC, 2004, CRC Press

□Source of figure

1) Bozorgnia and Bertero, Earthquake Engineering, ICC, 2004, CRC Press

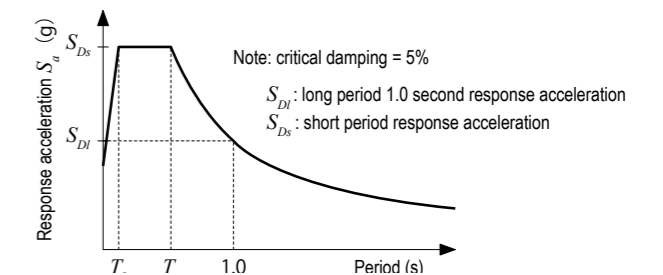
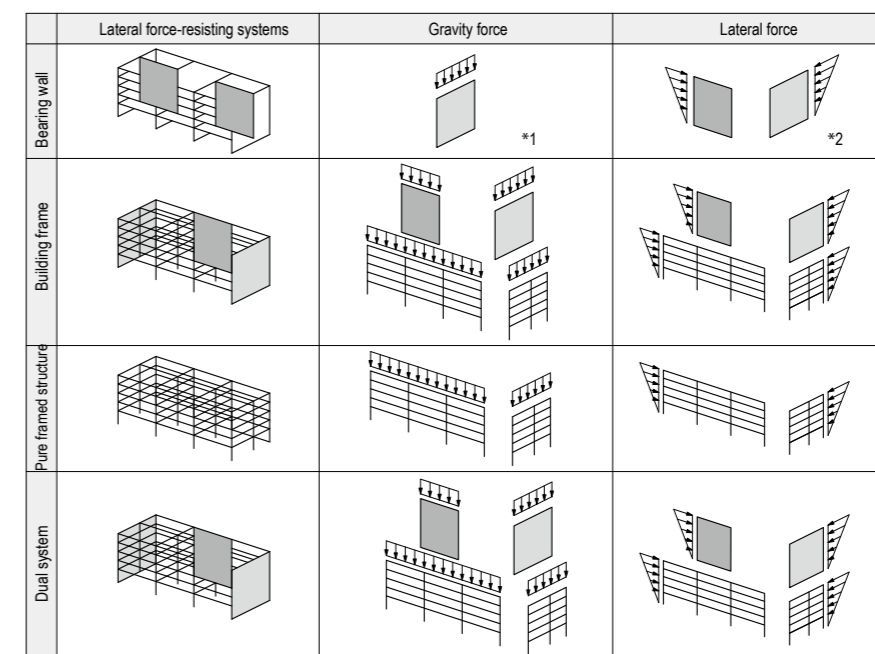

Figure 1. How to make a design acceleration response spectrum<sup>1)</sup>

Main seismic force-resisting system	Structural system limitations and building height limit					Response reduction factor R	Overstrength factor $\Omega_0$	Incremental displacement factor Cd
	Seismic design category							
	A and B	C	D	E	F			
Bearing wall systems (bearing walls and braces bear seismic force)								
Special shear wall	Not limited	Not limited	50 m	50 m	30 m	5	2.2	5
Ordinary shear wall	Not limited	Not limited	Not permitted	Not permitted	Not permitted	4	2.5	4
Building frame systems (building frames other than bearing wall bear seismic force)								
Special shear wall	Not limited	Not limited	50 m	50 m	30 m	6	2.5	5
Ordinary shear wall	Not limited	Not limited	Not permitted	Not permitted	Not permitted	5	2.5	4.5
Moment-resisting frame systems (pure framed structures)								
Special frame	Not limited	Not limited	Not limited	Not limited	Not limited	8	3	5.5
Intermediate frame	Not limited	Not limited	Not permitted	Not permitted	Not permitted	5	3	4.5
Ordinary frame	Not limited	Not permitted	Not permitted	Not permitted	Not permitted	5	3	2.5
Dual systems with special moment frames capable of resisting at least 25% of prescribed seismic forces								
Special shear wall	Not limited	Not limited	Not limited	Not limited	Not limited	8	2.5	6.5
Ordinary shear wall	Not limited	Not limited	Not permitted	Not permitted	Not permitted	7	2.5	6
Dual systems with intermediate moment frames capable of resisting at least 25% of prescribed seismic forces								
Special shear wall	Not limited	Not limited	50 m	50 m	30 m	6	2.5	5
Ordinary shear wall	Not limited	Not limited	Not permitted	Not permitted	Not permitted	5.5	2.5	4.5
One column systems								
Special frame	Not permitted	Not permitted	Not permitted	Not permitted	Not permitted	2.5	2	1.25

Table 1. Lateral force-resisting systems of reinforced concrete construction<sup>1)</sup>



\*1 Set bearing walls alone to bear gravity force.

\*2 Set all bearing walls and (even if not supporting any load) all orthogonal walls to bear lateral force.

Figure 2. Structural system limitations and building height limit and design factors and coefficient for seismic resisting reinforced concrete construction<sup>1)</sup>

## 4-4 Amendment of the law after the Great Hanshin-Awaji Earthquake

After the 1995 Great Hanshin-Awaji Earthquake, a seismic retrofit of those buildings compliant to old standards and a menu of earthquake resistant performances were required. With the market liberalization, the introduction of the performance based design method, the abolition of Article 38 of the Building Standard Law of Japan, the opening of the private sector's access to application for building confirmation, and the abolition of administration by circular notices were implemented. After the case of fabrication of seismic strength, assessment of the conformity of structural calculations and a qualification of a structural design 1st class architect were introduced.

### Lessons from the Hyogoken-Nanbu Earthquake

Structural designers have not adequately explained to clients, buildings occupants, and citizens about the facts and working assumptions incorporated into building design including such premises as the safety of buildings is equable, that in a seismic earthquake-resistant structure and the non-structural element it is assumed they will be damaged by an earthquake, and that building functions will not be maintained during or in the aftermath of an earthquake. It became apparent that a great gap exists between the factual reality of structural designers and the expectations of citizens regarding earthquake-resistant design.

### Act on Promotion of the Seismic Retrofitting of Buildings

In 1995, the Act on the Promotion of the Seismic Retrofitting of Buildings which imposes an obligation on citizens to carry out a seismic diagnosis and seismic retrofit of buildings built before 1981 was established (No penalty is applied for non-compliance).

### Seismic planning standards of government buildings

In 1996, the "Standard for comprehensive seismic planning of government buildings" was published. It classified government buildings into 3 categories, as well as classified the goals of seismic safety into 3 types for structures, 2 types for non-structural elements, and 2 types for architectural equipment. In addition, the adoption of seismically isolated structures and seismic-response controlled structures were permitted in accordance with the degree of functional maintenance expected during and after an earthquake.

### Housing Quality Assurance Act

In 1999, the "Housing Quality Assurance Act" was passed, and enforced in the next year, by starting the housing performance indication system. The "Japan Housing Performance Indication Standards" prescribed design seismic force as 1.5 times for Class 3, 1.25 for Class 2, and 1.0 for Class 1 regarding the structural stability in terms of earthquake resistant performance.

### Revision of seismic diagnosis guidelines

The "Standard for seismic assessment of existing reinforced concrete buildings" was published in 1977, revised in 1990, and following the Great Hanshin-Awaji Earthquake revised again in 2001, and prescribed calculations updated from man-

ual to a computerized method.

### Development of performance based design

With an agreement made in the GATT Uruguay round, the performance based design method was developed by a Japan-US joint effort. In 1995, in the United States, it was announced as "Vision 2000." In Japan, a comprehensive technological development project named "Development of new engineering framework for building" started following the earthquake, and was completed in 1997.

The limit strength calculation method was established in 2000, and the seismic calculation method based on an energy balance was established in 2005.

### Promotion of performance specification and abolition of Article 38

In 1998, with the amendment of the Building Standard Law of Japan, performance based design was adopted, and Article 38 was abolished.

With the abolition of Article 38, fairness and transparency were promoted, and the standards and guidelines which had been specially recognized by the minister or received a circular notice were publicly notified for five years. However, there was no great change except for the limit strength calculation and fire prevention performance calculation.

### Opening private sector's access to administrative services including application for building confirmation

The Omnibus Decentralization Act was established in 2000 as part of administrative reform, and administration by circular notices was abolished; most building administration services transitioned to local governments and were relegated to mayors and governors. In addition, applications for building confirmation, completion inspections of construction, and intermediate inspections were opened to private sector access.

### Case of the fabrication of structural calculation sheets

In 2005, a case involving the fabrication of structural calculation sheets was exposed. In 2006, the Building Standard Law of Japan, etc. was revised in order to prevent the recurrence of such cases. Designated agencies for assessing the conformity of structural calculations were established, and buildings higher than a certain height or those for route 3 were subject to an assessment of the conformity of structural calculations.

### Revision of Article 20

Building structures were classified into four types, all of which became subject to the verification of safety. These great changes stated that "the calculation method stipulated by the minister" and "continuously occurring deformation" were to be added. Performance based design is not viable without evaluation of deformation.

### Assessment of the conformity of structural calculation and revision of notification

In 2007, Type 2 and Type 3 buildings became subject to assessment of the conformity of structural calculations (Figure 1). Therefore, it became necessary to legislate the technical standards which had become customary practices in societies and associations, and 37 notifications with 287 pages were established. Furthermore, 9 notifications were added later.

### Structural design 1st class architect

In 2006, the Act on Architects and Building Engineers, etc. was revised, and a qualification of structural design 1st class architect was established. The qualification was certified in 2008.

(Toshio Okoshi)

□Reference

(1)Architectural Institute of Japan, Evaluation Procedures for Performance-Based Seismic Design of Buildings, 2009

□Source of figure

1) Supervised by the Building Guidance Division, Housing Bureau, Ministry of Land, Infrastructure, Transport and Tourism, etc., edited by the Editorial Committee of Practical Guide for Structure-related Technical Standards of Buildings, 2007 Practical Guide for Structure-related Technical Standards of Buildings (Japanese), Official Gazette Co-operation of Japan, 2007

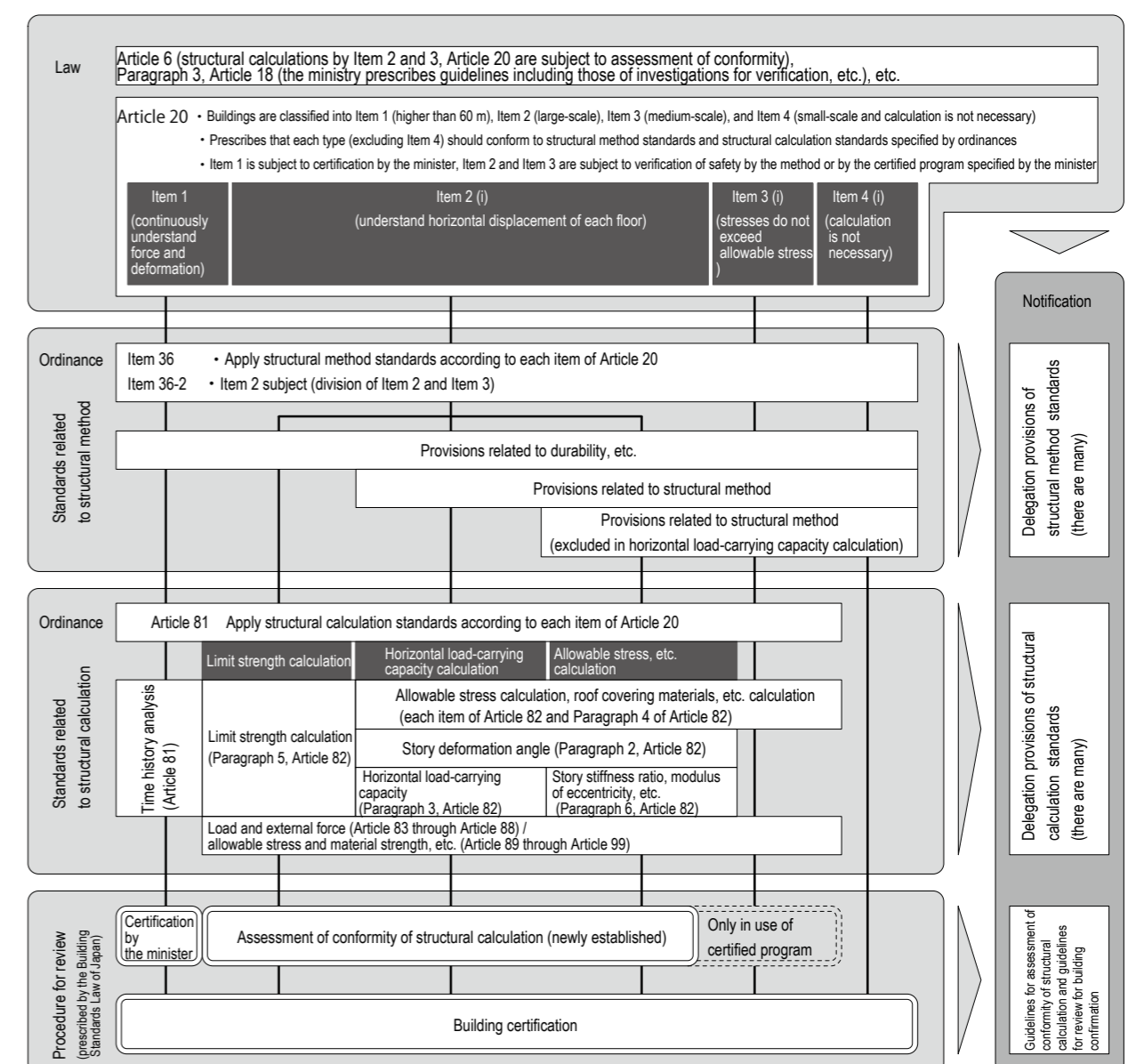

Figure 1. Application of main prescriptions related to structure<sup>1)</sup>

## 4-5 Earthquake resistant performance and structural frame costs

For some time after World War II the modernism school of architecture prevailed, and earthquake resistant performance meant fulfilling earthquake resistant standards in the Building Standard Law of Japan, resulting in the structural frame cost becoming an important factor of structural design. At the time of postmodernism, however, architecture and structural performance were diversified, a performance-oriented design method was adopted, and therefore, it became difficult to evaluate earthquake resistant performance and structural frame costs in a simple way.

### Modernist architecture

After World War II ended, modernist architecture prevailed. Although building construction methods changed from the envelope of shear walls to pure framed structures, the earthquake-resistant design method did not change. Good design meant that the amount of reinforcing steel and concrete used was less, and decreasing reinforcing bars by adding spandrel and hanging walls was highly valued.

After the 1968 Tokachi Earthquake, the Enforcement Order of the Building Standard Law of Japan was amended in 1970 and standard spacing of hoops was changed to 10 cm. With the amendment in 1981, the bend of a rebar end by 135 degrees and welded hoops were made in factories, and pre-assembly prevailed (Figure 1).

The 1995 Hyogoken-Nanbu Earthquake conclusively proved the difference in earthquake resistant performance between the old and new standards. However, the difference in structural frame costs was very little, showing earthquake resistant performance is not directly linked to structural frame expenditure (Figure 2).

### New earthquake-resistant design method

With the amendment, though intermediate story collapses could be prevented, the story shear force of intermediate stories and axial force of low story columns increased, resulting in increased costs.

Steel frames for steel encased reinforced concrete started from the open web type. In the late 1970s both the open web and full web type were used together (Figure 3). Since 1981 the full web type has been exclusively used and the shear capacity and ductility were strengthened, but resulted in considerable cost increases. Many structural engineers were of the opinion the full web type was not appropriate because the concrete would split.

As for columns with a steel frame structure, the traditional H-section covered with steel plate to give a box-like shape fell out of use, and box-shaped steel became popular. Sections were determined by deformation restriction and width-thickness ratio, and the strength considerably increased, but again this resulted in significant cost increases. As a result braces were eliminated, and space could be used more effectively and with better economy.

### Strength coefficient for building use and structural frame costs

A report in 1993 by Jun Kanda titled "Assessment of the economic factors on optimum reliability" reported that assuming the structural frame cost with a standard shear coefficient

of 0.2 was 1.0, that of 0.3 became 1.2 times greater, and that of 0.4 became 1.4 times greater.

However, now that the required concrete strength has increased from 20 N/mm<sup>2</sup> to 100 N/mm<sup>2</sup>, and the unit price of steel violently fluctuates due to the rise of China, and foreign exchange rates are so volatile, it has become necessary to respond in accordance with the prevailing conditions at the time of design.

### Office building

As long spans and complete air-conditioning become the mainstream, beam sections are now preferentially determined by deflections, habitability against vibrations, and the layout of air-conditioning ducts, rather than structural design. Structural frame costs have become comparable with the cost of curtain walls, and as the cost of air-conditioning equipment has exceeded 40% of the total cost, the structural frame cost has become about 20%.

### Condominium

As the structural planning of many condominiums is decided by clients, there is little creative freedom for engineers. Floor heights are uniform, column sizes and beam depths are determined based on a sales and construction rationale, and slab thicknesses are determined based on sound insulation performance. There is no room for studying structural costs. Today the role of the structural engineer is limited to deciding beam widths, concrete strengths, and rebar sizes and strengths.

### Postmodernism architecture

Modernist architecture was created by a harmonious combination of design, structure, and equipment. It was rational, was lower in cost, and prioritized the position of columns and floor frames.

As Le Corbusier, a pioneer of modernist architecture, so uncompromisingly proclaimed with his Chapelle Notre-Dame du Haut, uniform boxes were too rational and boring.

Postmodernism architecture, which started with AT & T (F. Johnson, 1984), was said to have given freedom from structure to design; its structural form cannot be recognized by its appearance.

The structural form of Tokyo Metropolitan Main Building No. 1 (Kenzo Tange, 1991) is a mega-frame with four built-up columns (Figure 4). In this instance economy and rationality were of second importance.

Furthermore, when it comes to structural expressionism or architecture free from X-Y coordinates, the category of structural frames cannot be distinguished.

### Performance based design

Performance based design of structure is materialized by adopting additional strength, seismically isolated structures, seismic-response controlled structures, etc.

Seismically isolated structures and seismic-response controlled structures were developed to ensure a building's function and habitability at the time of an earthquake or strong winds, and required an additional cost. However, as they increased in popularity, they became to be used as a device for fulfilling legally required structural performance standards.

As structural design coherent programs became popular,

there is no choice in terms of structural frame costs after the structural planning is fixed. Therefore, the structural frame cost is evaluated at the stage when performance objectives are fixed.

(Toshio Okoshi)

### Reference

(1) Japan Structural Consultants Association, Taishin kouzou sekkei handobukku (Earthquake-resistant design handbook), Ohmsha, 2008

### Source of figure

1) Kenchiku-bunka (Journal of Japanese Architecture), May 1995, Shokokusha

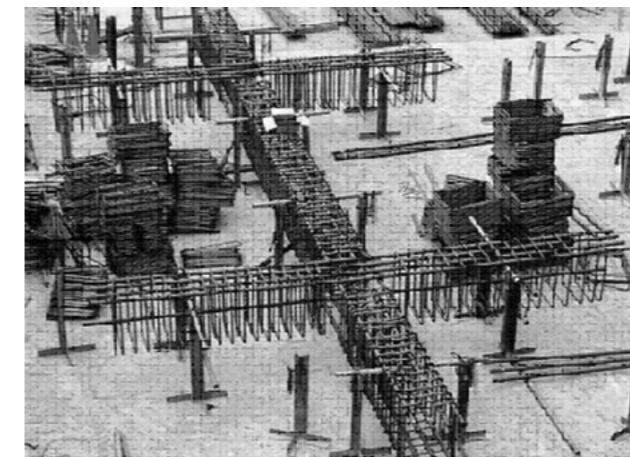

Figure 1. Welded hoops and stirrups



Figure 2. Hoops with spacing of 30 cm before 1970 (photo by: Faculty of Engineering, Tokyo Denki University)<sup>1)</sup>



Figure 3. A steel encased reinforced concrete building, whose intermediate story with open web type columns collapsed

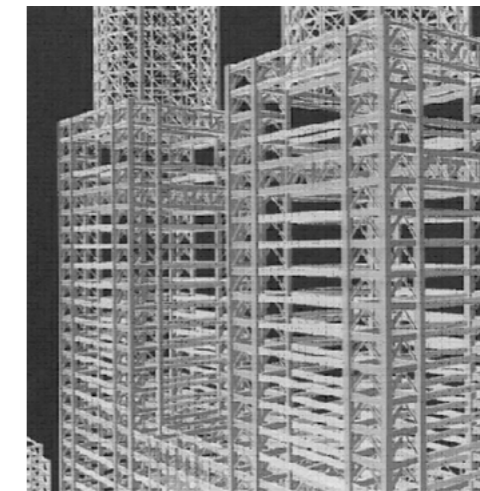

Figure 4. The structure of Tokyo Metropolitan Main Building (Source: Muto Associates)



## 5 Different Earthquake Resistance Performance Depending on the Building

### 5-1 Buildings that protect human lives and functions

The requirements for earthquake resistance performance are to ensure the protection of human lives and the retention of functions. Previously, depending on the type and purpose of a building, appropriate earthquake resistance performance could be selected, and consequently the goals of the design could be established. However, the experience of the Great East Japan Earthquake has given rise to additional requirements against unexpected events. It is now necessary to consider countermeasures, including intangible ones (human systems, procedures, etc.), against earthquakes which exceed the expected earthquake resistance performance.

#### Seismic criteria

The earthquake resistance performance will differ depending on the role of a building.

For example, a "disaster base facility," which serves as a command center during a disaster, requires a higher earthquake resistance performance, and is usually accommodated in administrative agency buildings. The same goes for a disaster base hospital, as well as an auditorium/gymnasium of a school which serves as a temporary gathering location. The requirements for earthquake resistance performance differ depending on the building type, and naturally, the required structural performance is different depending on the building type. For a disaster base, for example, ensuring communication functions is essential. It is important for a hospital to secure the water and electric power needed for the treatment of the injured and patients. For an emergency shelter, it is important to secure not only safe spaces, including safe non-structural building elements, but also the water, sewage, and electric power needed to maintain the daily survival of the refugees. It is necessary to consider from many angles what level of earthquake resistance performance is required.

#### Different earthquake hazards depending on the time of day, age, and region

Three great earthquakes have occurred in the last hundred years, and each has a particular disaster signature. In the 1923 Great Kanto Earthquake damage caused by fires was predominant, in the 1995 Great Hanshin-Awaji Earthquake, many deaths were caused by the collapse of buildings and crushing, and the 2011 Great East Japan Earthquake caused massive damage by tsunami. Each region has different requirements to ensure adequate provision against disasters, but a common feature is the urgent need to secure the earthquake resistance of buildings and to prevent the overturning of furniture. In the aftermath of all of these earthquakes, rubble and overturned furniture caused fires, blocked escape routes, and added to the damage. It is estimated that if an earthquake of seismic intensity 7 directly hit Tokyo, the majority of deaths will be caused by fires.

#### Indoor damage

Most of the deaths and injuries caused by an earthquake are due to the moving/overturning of furniture and falling objects. All such items must be physically fixed to the structural frame; very little is achieved by attaching them to finishing materials. Therefore, they should be embedded into substrate

before finishing work.

The typical residential environment of today is multistoried, and the upper floors of a multistory building will shake more violently than the ground floor because the movements are amplified (Figure 1). In terms of seismic intensity, shaking on the upper floors is usually one or two levels greater than those on the ground floor. This is why upper floors especially, require indoor countermeasures against an earthquake.

#### Securing escape routes

To protect life involves moving from a dangerous place to a safer place, and the first prerequisite is to secure an escape route (Figure 2). There are three important points to consider. (1) to step out from the room into a corridor, (2) to pass through the corridor and reach outside, and (3) finally, to make it safely to a road. During and after an earthquake, objects will be thrown around and fall, and this naturally causes many people to panic.

Assuming blackouts immediately after an earthquake, it is necessary to ensure a safe escape route in darkness. Regarding point (1), doors have been blocked by drawers sliding out, even though the furniture did not overturn. In point (2), bulky objects placed in the corridor may block the passage. In addition, an entrance lobby, which is essential for a safe escape, is often finished with attractive stone tiling, which is prone to falling off. Regarding point (3), bicycles left on the road, or structurally unstable concrete block walls have prevented safe passage. Routes to temporary gathering locations should be checked on a regular basis for safety. Furthermore, in any area where great fire damage is likely, such as densely crowded districts of wooden buildings, it is necessary for the residents to escape by helping each other. Therefore, the formation of communities where residents have good communication with each other on a regular basis is certainly beneficial.

#### Ensure functions, protect livelihoods

It is desirable that earthquake resistance performance includes the ensuring of necessary functions. The importance of each function will differ depending on the building. Therefore, the earthquake resistance of a particular building should be improved by defining the priority of importance; securing electric power and water for every building is critical. One of the issues recently raised is generators. After the Great Hanshin-Awaji Earthquake, many generator failures were caused by damage to cooling water tanks. Although ordinary generators are installed to cope with a power failure, many of them cannot run for longer than 3 hours, even with additional fuel; they are not made for long term operation. It is important to select an appropriate generator according to the needed function. In addition, during the Great East Japan Earthquake, the cooling tanks of a nuclear power plant were washed away, bringing all functions to a complete stop. This clearly indicates the importance of equipment layout.

Some facilities consist of a group of buildings, and it is important for all buildings in a complex to be built on ground with uniform conditions. It should be noted that when conditions differ, differential settlement may occur and piping may be damaged, along with the possible stoppage of all the facility's functions.

For important facilities, it is also necessary to install dual systems and prepare for the worst-case scenario. Although

important performance differs depending on the type of facilities, it is essential to maintain required functions. However, unexpected events may occur in any situation where tangible countermeasures, including installation or storage of equipment, have been prepared. Therefore, it is necessary to prepare intangible countermeasures on a regular basis, such as human systems and procedures. Elevators, which have a low earthquake resistance, are an especially serious issue; they usually stop at a low seismic intensity of about 4. Commonly residents have been trapped in old type elevators, and some new type elevators in condominiums open their doors only at residential floors. It should be recognized that newer buildings will be subject to greater control and monitoring by an increasing array of electrical systems; such a building will have more weaknesses in terms of its functions, and it is necessary to consider and make intangible preparations against potential breakdowns and emergency situations.

The following areas should be checked on a regular basis and systems updated to take account of changes.

As a community, (1) mechanism of fire extinguishers, (2) evacuation guidance, (3) information gathering, (4) confirmation of people's safety, (5) aid for the injured, (6) aid for the disabled, frail, and elderly, and (7) countermeasures including stockpiling of goods.

As individual preparation, (1) fixing furniture and equipment, (2) prevention of any fire outbreak, (3) ensuring opening/closing of entrance doors, (4) preventing fire spreading to/from neighbors, and (5) mutual aid and assistance.

#### Preserve assets, protect human lives

To preserve assets, it is important to minimize damage to the building. When a building has suffered more or less cosmetic damage, restoring the damaged part has caused problems between engineers and the local residents. After the Great Hanshin-Awaji Earthquake, simple superficial cracks in non-structural walls, were seen by experts as evidence of the kind of light damage to be expected from such an earthquake; they were proof of the efficiency of the building's design. Residents had a very different view, and interpreted the cracks as evidence of the building being severely damaged by the

earthquake. This clearly shows a considerable gap in the perception of earthquake damage between the two groups, and in the Great East Japan Earthquake, residents developed a distrust of the assessments made by engineers. While it is desirable that the degree of damage is kept to the minimum, it is necessary to establish countermeasures against earthquakes giving the highest priority to protecting people's lives.

(Junichi Nakata)

□ Source of figure

1) Japan Aseismic Safety Organization, Seikatsu wo mamoru taishin tebiki (Guidelines for earthquake resistance to protect livelihoods), Gihodo Shuppan, 2008

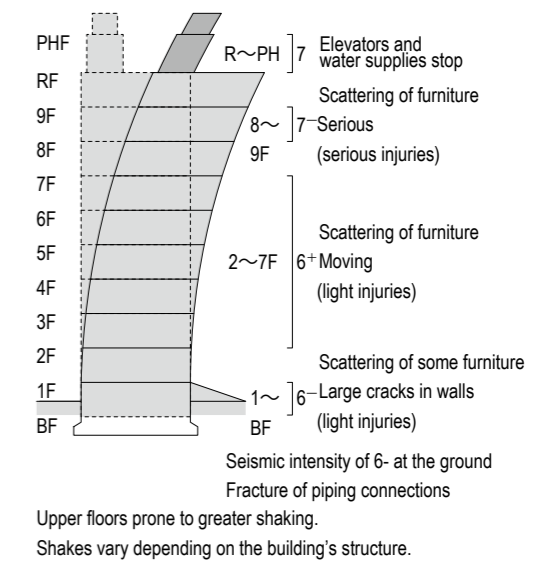

Figure 1. Height and the degree of shakes<sup>3)</sup>

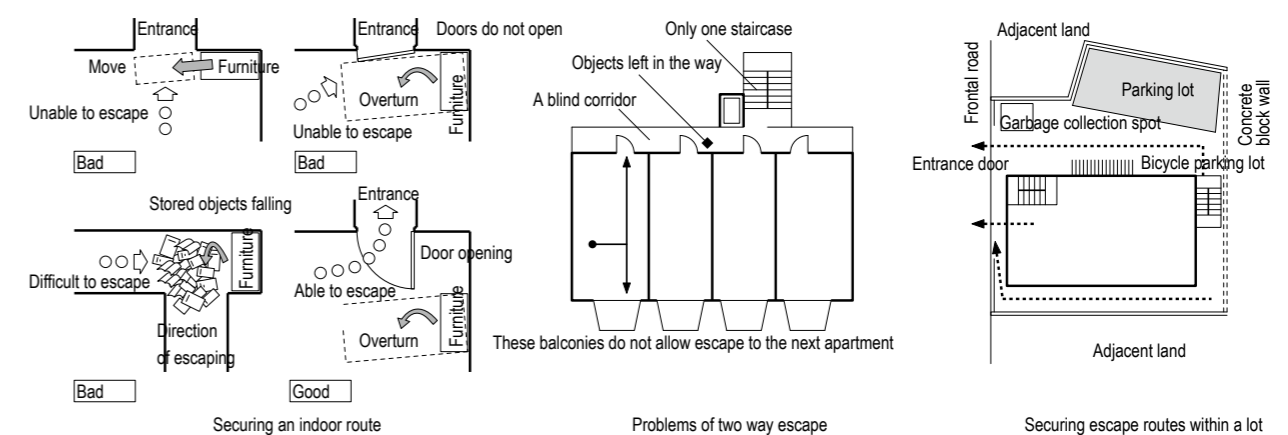

Figure 2. Escape route<sup>3)</sup>

## 5-2 Securing functions and business continuity

Nowadays it is not enough to just protect only human lives and buildings against earthquakes; the demand to secure and recover a building's functions as quickly as possible is increasing. Business continuity planning (BCP) to enable continuous living and working is becoming a key architectural goal. Today, seismic countermeasures are a part of the comprehensive risk management of a building.

### Protecting not only lives and buildings but also functions

The basic concept of the new Earthquake-Resistant Design Standards which were established in 1981 are two-fold: damage to the structural frame of a building should be prevented against medium seismic motions that frequently occur during the building's durable period (it is called primary design); and when subject to great seismic motions, which rarely occur during the building's durable period, the building does not collapse and it protects human lives, even though the structural frame may suffer a certain degree of damage (it is called secondary design). To meet these standards it is important to design the building structure taking into consideration the kind of damage it may suffer.

The secondary design is intended to protect human lives by preventing the collapse of the building, at the cost of the structural frame absorbing seismic energy and suffering some degree of damage. To achieve this, ultimate strength design with a beam side-sway mechanism that prevents a total collapse is required.

The experience of the Great Hanshin-Awaji Earthquake has made it clear that settling for only protecting human lives by preventing the structural frame's collapse is not enough for the overall well-being and functioning of society, although the effectiveness of the new standards has been highly evaluated. It is not just a question of protecting life and property, it is important to ensure the structural frame's strength from the perspective of securing functions and as much as possible their early recovery; this is an essential prerequisite for especially important buildings.

This is easier said than done, as strong seismic motion with a short period, which is a characteristic of earthquakes occurring directly underneath urban areas, will cause greater shaking when the structural frames of medium- and high-rise buildings of ordinary earthquake-resistant construction are strengthened, and will give a greater acceleration to non-structural elements which support the building's functions, such as equipment, elevators, furniture and stored objects. In essence, although the structural frame remains standing without any damage, the cost of the buildings survival is paid for by a high degree of interior chaos, making it quite likely the building's functions will be severely damaged and not work. It is a paradox; we destroyed the functions to save the building.

From the perspective of securing functions, safety of the architectural space is assumed to be of paramount importance. Technically, earthquake response values (earthquake acceleration of each story, relative story displacement, etc.) will be a great issue, and the limit values for securing functions will be discussed. This is why seismically isolated structures and seismic-response controlled structures have been widely adopted since the Great Hanshin-Awaji Earthquake. With the develop-

ment of these techniques, it was possible to concretely discuss measures from the perspective of securing functions.

(Narifumi Muraio)

### Business continuity planning (BCP) requires grasping the risks and geographical decentralization

The goals of securement and recovery of functions vary depending on a building's use. In the case of a house, it is to continue living in your home; for a factory, it is to keep manufacturing and delivering; for a company, it is to continue carrying out its business. And in the case of an electric power plant, it is to keep generating electricity. Planning how to achieve these goals in advance is known as business continuity planning (BCP). Although the stricken areas of the Great Hanshin-Awaji Earthquake and the 2004 Chuetsu Earthquake were relatively limited, the Great East Japan Earthquake covered some 500 km in length. Possibly the predicted Tokai-Tonankai-Nankai Earthquake is also foreseen as a consolidated type great earthquake. Against such an extensive disaster, it is necessary to take countermeasures involving parallel functioning by dispersing functions on a national scale. Considering a wider area, dispersing them over several countries may be needed. In today's intricate society, business cannot be continued only by protecting central facilities such as a headquarters and office or a main factory. Through the experience of the Great East Japan Earthquake, it became apparent that diversification of risk of a whole supply chain including over-crowding of cooperative firms is necessary.

### Planning of a BCP-considered building as a whole is required

The following points should be considered in the planning of a house, shop, or office.

- (1) Attention should be paid to the specific location, as the risk varies even within the same area. The geography and history of the site may be of help, and its risk should be checked with a public hazard map. However, whatever conclusions and assumptions are made, consideration should be given to measures to deal with a more serious situation than anticipated. An accessible place to act as a disaster refuge should be secured.
- (2) Attention should be paid to the configuration of the utilities of the infrastructure including increasing the number of electric lead-ins, diversifying thermal energy sources, and increasing communication media. Use of well water is also effective.
- (3) Attention should be paid to the layout of buildings within the site. Risks vary depending on the manner in which the buildings connect to roads as well as to other buildings around the lot. Open spaces and green spaces are also effective.
- (4) A method to confirm the safety of the constituent members (local residents, workers, etc.), an emergency response system and manual should be established, and training should be conducted.
- (5) In response to risks, the applicability and possible adoption of seismically isolated structures and seismic-response controlled structures should be considered.
- (6) In order to avoid damage and ensure the rapid recovery of electric rooms, generating rooms, and machine rooms, the feasibility of locating them on upper floors should be con-

sidered. Furthermore, attention should be paid to the layout of air conditioning equipment rooms, ESPs, DSs, PSs, etc. Purposes and periods for the use of any generators during blackouts should be established, and fuel stockpiles should be determined.

- (7) A back up system for computer systems and data should be ensured.
- (8) Provision of food stocks and bedclothes for escaping or recovering functions by staying overnight should be made.
- (9) The possibility of continuing business on the upper floors should be considered, when the lower floors are out of action due to a tsunami or flooding. It should be assumed

to secure one or more safe buildings from among several buildings and to establish backup offices and emergency response rooms.

In chronological order, when looking at the Great Hanshin-Awaji Earthquake in 1995, the September 11 Attacks in 2001, the Great East Japan Earthquake, and Thailand's Great Flood in 2011, it is apparent the smaller the world became due to the progress of transportation and communication, the greater and quicker the damage from these events extended. As the speed of progress and the scale of disasters increase exponentially, so too must countermeasures also become more comprehensive to catch up.

(Kazuo Adachi)

Risk item	Item	Item	Risk item
Structure	Building	Location	Plate
Equipment			Zone/country/region
Escape			Weather
Fire protection/fire resistance			Area/district
Furniture and fixtures			Site
Neighborhood group	Human	Infrastructure	Electric power
Constituent members			Water supply
Family members			Sewage
Clients			Thermal resource/gas/oil
Cooperative firms			Broadcasting
Health	Software	Economy	Communication
Nation			Currency
Communication system			Stock market
IT system/PC			Market
Data			Food
Attack by virus			Reputation

Table 1. List of risk items for BCP

Risk is evaluated concerning the probability of occurrence and scale of damage. It is important to spread risks.



Figure 1. Kesenuma-shi Uo-Ichiba (fish market) in Miyagi prefecture quickly recovered. Fortunately, the structure of the market was strong and durable.



Figure 2. The City Hall of Rikuzentakata in Iwate prefecture suffered from flooding higher than the roof and was unable to function.



Figure 3. A massive amount of medical records were lost in the flood. It will take a great amount of effort to recover them. Backups should have been taken.

### 5-3 Public requirement and client requirement

The earthquake resistance performance required by the public sector and private sector do not necessarily match. For example, earthquake resistance performance publicly prescribed in the Building Standard Law of Japan is just a minimum standard to be followed. However, citizens expect maximum standards for public buildings. How should the level of building earthquake resistance performance be determined?

#### Determining the level of public building earthquake resistance performance

The Great East Japan Earthquake, affected many public buildings so badly they were unable to function. When a public building, which manages important private information and provides various administrative services, suffers damage from a disaster, the impact on the livelihood and the economy of local communities is immeasurably great. In the aftermath of the Great East Japan Earthquake, the local government whose offices suffered damage, for some considerable time were unable to fulfill such basic administrative tasks as releasing a roll of the dead.

As mentioned above, the Building Standard Law of Japan prescribes only minimum standards, meaning that in most cases the decision on the level of earthquake resistance performance of buildings is left to the owners. In order that government buildings can continue to function in the event of disasters, the state has prepared "Comprehensive seismic planning standards for government buildings," in which the importance factors of facilities are prescribed (Table 1). An importance factor is a factor for adding extra force to the seismic force when designing buildings. The factor for ordinary buildings is based on a design goal where even if the building suffers damage in a great earthquake it does not collapse to protect human lives. On the other hand, the factor for disaster bases and data centers is based on a design goal where not only the structural frame but also equipment suffers only minor damage from a great earthquake.

Structural frames have been classified into Category I, II, and III, and the importance factor is determined as: Category III: 1.5, Category II: 1.25, and Category I: 1.0. The Tokyo Metropolitan Government, as is the case with the state, has prescribed a strength coefficient for building use according to the degree of importance in terms of disaster prevention, including such coefficients as for those buildings that are prescribed in earthquake disaster countermeasure ordinance and those buildings that many people use (Table 2). The strength coefficient for building use is used for adding extra capacity to the horizontal load-carrying capacity required for each floor according to a target level in the secondary design within the permissible story deformation angle. In this way the state and many local governments have established earthquake resistance performance levels by determining the importance factors of public buildings, and placing an emphasis on retaining essential functions as disaster bases.

#### Determining the level of private building earthquake resistance performance

The earthquake resistance performance stipulated in the Building Standard Law of Japan is just a minimum standard to

be followed; from the perspective of economic efficiency, it is reasonable for the Law to ensure a minimum standard to prevent the collapse of buildings and protect human lives against a great earthquake which can happen at any time. Even so, it is also true that in the case of private buildings, from the standpoint of protecting human lives, the earthquake resistance performance of the facilities where vulnerable people in disasters or many people gather should be improved.

At the time of the Tohoku Earthquake, most means of transportation in the areas around Tokyo including railroads were suspended, and the number of stranded persons was about 3,520, 000 in the Tokyo metropolitan area. After the earthquake the Tokyo Metropolitan Government enacted the Ordinance for Comprehensively Promoting Measures for Stranded Persons, based on a policy of "restraining concurrent returning home." The ordinance imposes on companies, schools, and large-scale facilities where many people gather, including department stores as well as railroad stations, an obligation to make the utmost efforts to "restrain concurrent going home" at the time of major disasters.

Specifically, it imposes on companies and the like a duty to make the utmost effort to enable employees to wait on-site, and to keep in stock three days' worth of food and water. Large-scale facilities where many people gather including department stores as well as railroad stations, must protect visitors and users, and schools, etc. must secure the safety of pupils and students.

The ordinance does not include any prescription on the earthquake resistance performance of buildings. However, those buildings required to make the utmost effort are naturally required to maintain their functions at the time of great earthquakes. As mentioned above, importance factors of public buildings have been determined mainly for the purpose of maintaining their functions as disaster bases.

On the other hand, there is no law or index for private buildings that have been established by the state or local governments. Therefore, private buildings have been designed according to an individual client's requirement. In a situation like this, it is a new initiative for the Tokyo Metropolitan Government to request private buildings to share a role as a disaster base at the time of great earthquakes.

Among private buildings, the following are regarded as important.

Segment (1): those facilities where many people gather, as well as those which can be used for disaster bases

Examples: railroad stations, airports, sports and cultural facilities, and commercial facilities, etc.

Segment (2): those facilities which accommodate vulnerable people in disasters

Examples: hospitals, care facilities, educational facilities, etc.

Segment (3): those facilities where a large quantity of hazardous materials are stored or used

Examples: nuclear power plants, petrochemical complexes, etc.

Those facilities described above, including private ones, can be said to be highly public. Therefore, it should be highly effective to promote those facilities' earthquake resistance performance from the perspective of not only the protection of human lives but also the conservation of social wealth. Especially, those facilities that can be expected to serve as bases

for refuge or disaster prevention will have a greater effect when not only their original functions are maintained but also the functions of disaster bases are promoted.

The Building Standard Law of Japan has left the earthquake resistance performance levels of buildings up to the client's discretion. However, if social consensus is obtained, it might be necessary to establish indexes to promote earthquake resistance performance of those facilities that can be expected to serve as the disaster bases.

For example, as in the above-mentioned case of Tokyo, it should be possible to establish by law or ordinance prescrip-

tions for promoting the earthquake resistance performance of private buildings, which local residents agree to regard as highly public, based on disaster prevention planning in accordance with the local characteristics.

Experience of the Great Hanshin-Awaji Earthquake and the Great East Japan Earthquake, which were catastrophic disasters unparalleled in history, and were near national crises, has given rise to the need for a broad-ranging discussion, not from a perspective of restrictions on private rights, but aiming at obtaining consensus on what is required to protect the lives and the properties of local residents. (Shigeo Morioka)

Building element	Classification	Goals of seismic safety
Structural frame	Category I	After a great earthquake, the building can be used with no repairs to the structural frame. Protection of human lives and adequate preservation of functions are secured. -> Addition of extra capacity to required horizontal load-carrying capacity: 1.5
	Category II	After a great earthquake, the building can be used with no large repairs to the structural frame. Protection of human lives and preservation of functions are secured. -> Addition of extra capacity to required horizontal load-carrying capacity: 1.25
	Category III	Though partial damage occurs to the structural frame, the decrease of the building's strength is not great. Protection of human lives is secured. -> Addition of extra capacity to required horizontal load-carrying capacity: 1.0 (no extra)
Non-structural building element	Category A	After a great earthquake, no damage or movement of the non-structural building elements, which could prevent trouble-free disaster emergency activities or the management of hazardous materials. Protection of human lives and adequate preservation of functions (outside, and activity base and route) are secured.
	Category B	Even when any damage or movement of the non-structural building elements occur due to a great earthquake, protection of human lives and prevention of secondary damage are secured.
	Common	It should be considered that the functions of the building equipment are not disturbed, and they continue to work.
Building equipment	1st category	After a great earthquake, protection of human lives and prevention of secondary damage are secured, as well as the continued use of any required equipment functions for a significant period with no major repairs.
	2nd category	After a great earthquake, protection of human lives and prevention of secondary damage are secured.
	Common	It should be considered that equipment, piping, etc. that should function even after a great earthquake will not be damaged due to additional hazards. Also, countermeasures against breakdown of utilities should be considered.

Table 1. Comprehensive seismic planning standards for government buildings (Ministry of Land, Infrastructure, Transport and Tourism)

Classification	Target level	Intended facilities	Examples of building use	Strength coefficient for building use
I	After a great earthquake, the building can be used with no repairs to the structural frame. Protection of human lives and adequate maintenance of functions are secured.	Especially important facilities among those necessary for disaster emergency countermeasure activities Those facilities where a large quantity of hazardous materials are stored or used, or other similar locations	•Tokyo Metropolitan Main Building, local disaster prevention center, and disaster prevention communication facility •Fire department and police station •Adjunct facilities of above (housing for governmental workers is included in Category II)	1.5
II	After a great earthquake, the building can be used with no large repairs to the structural frame. Protection of human lives and preservation of functions are secured.	Those facilities necessary for disaster emergency countermeasure activities Those facilities which are regarded as a disaster refuge in a local disaster prevention plan Those facilities where hazardous materials are stored or used Those facilities used by many people, except those included in Category I	•Building of local government •Hospital, health center, and welfare facility •Meeting place, hall, etc. •School, library, social/cultural/educational facilities, etc. •Large-scale gymnasium, hall facility, etc. •Market facility •Stockpile warehouse, disaster stockpile warehouse, disaster equipment facility, etc. •Adjunct facilities of above	1.25
III	Though partial damage occurs to the structural frame, the decrease of the building's strength is not great. Protection of human lives is secured.	Facilities which are not included in Category I or Category II	•Dormitory, condominium, housing for workers, factory, garage, corridor, etc. * Urban facilities are separately considered.	1.0

Table 2. Recommendations for structural design by Tokyo Metropolitan Government

### 5-4 Importance level of a building

The levels of performance required for a building are determined by clients or users. Designers prepare tools for determining performance, and then quantify and convert them into tangible forms. This process requires not only compliance with laws, but also scientific verification based on experience, including data from past earthquakes, as well as social consensus.

#### Diversification of performance requirements

The performance levels required for buildings are growing increasingly diverse. Designers design buildings by repeatedly making and refining their decisions. However, these decisions are not accepted without conditions, as social consensus and compliance with the law are required. As a basis for social consensus, some sort of scientific verification of safety based on experience, including the study of past earthquakes is required. In particular, with regard to the structural performance of a building, the criteria to be fulfilled have not been clearly presented.

#### Performance design (performance-oriented design)

Architectural design has been left up to experts including designers and has been implemented in compliance with the law. However, users including clients who provide funding should primarily bear the rights and responsibilities for decisions on architectural performance, including safety levels. The experts are required to help the users make appropriate decisions. In this regard, however, minimum regulations are necessary to the restrictions for grouping on public welfare, etc. The experts including designers are required to design the environment for an individual building project in accordance with the client or user requests, as well as being required to have an ability to make comprehensive assessments of plans.

In the wake of the Housing Quality Assurance Act in 2000, etc., design has transitioned to performance-oriented design, which requires a specific menu for deciding target performance levels.

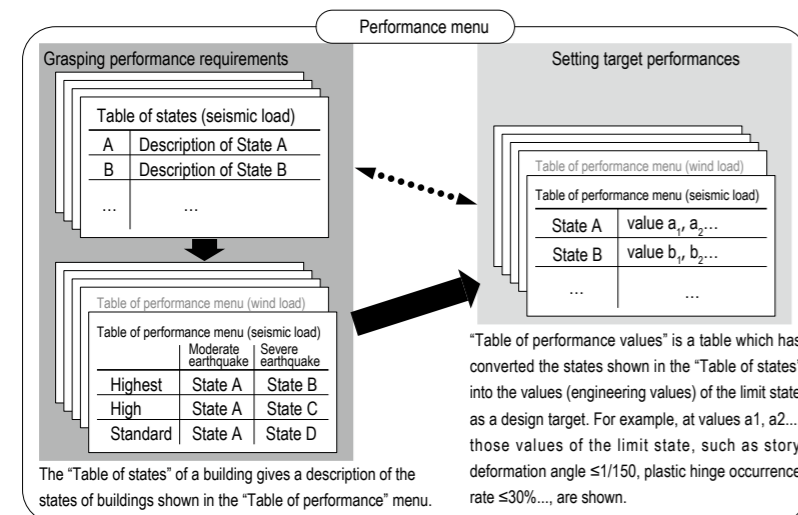

Figure 1. Performance menu1)

#### JSCA performance menu

In 2006, JSCA (Japan Structural Consultants Association) prepared a JSCA performance menu as a tool for embodying target performance through a process of performance design.

The performance menu (Figure 1) consists of three tables: "Table of states" (Table 1), "Table of performance menu" (Table 2), and "Table of performance values."

Even when the types and the magnitudes of loads to buildings are the same, the states (responses and behaviors) differ depending on the building. Such difference is defined as the "performance grade" (Figure 2) in the Table of states.

The performance grade is classified into three grades: "standard grade," "high grade," and "highest grade," and set for each load type. The "standard grade" is by and large comparable to the performance prescribed in the Building Standard Law of Japan.

First, the performance requirement of the client is replaced by a state (state A, state B, etc.) using the "Table of states," then, the agreed and confirmed state is applied to the "Table of performance menu," and finally, a performance grade is determined.

In actual design, it is necessary to quantify the state, which is shown in the "Table of performance values." Taking this quantified state as the design target value, validation then starts.

The greatest challenge here is "digitizing performance," that is, quantification. Such quantification means sharing concept images of the extent of damage and restoration of structural frames in society. Technically, it is necessary to organize and disclose data related to story deformation angles, ductility factor of members, crack width of concrete structures, local buckling of steel structures, etc. Furthermore, performance of a building is not determined by the structural frame alone. It goes without saying that the response (acceleration/displacement) of structural frames should be consistent with the performance of non-structural building elements and durable equipment.

#### Earthquake resistance performance of government facilities

Target performance of earthquake resistance for the state

and local government buildings are shown in the "Comprehensive seismic planning standards for government buildings and interpretations," and regarding the renovations of existing buildings are shown in the "Comprehensive seismic diagnosis/renovation standards for government buildings and interpretations." These standards are intended to ensure government facilities meet the required earthquake resistance performance in order to prevent earthquake hazards affecting administrative functions.

These standards prescribe target safety performance of earthquake resistance with evaluation of not only the structural frame but also non-structural building elements and building equipment. From the perspective of securing functions after a great earthquake, the structural frame

is classified into three categories: Category I, II, and III, and the non-structural building elements into Category A and B, and building equipment into 1st category and 2nd category, and are combined for the whole.

□ Source of figure  
1) JSCA Performance Menu, Japan Structural Consultants Association

(Mitsugu Asano)

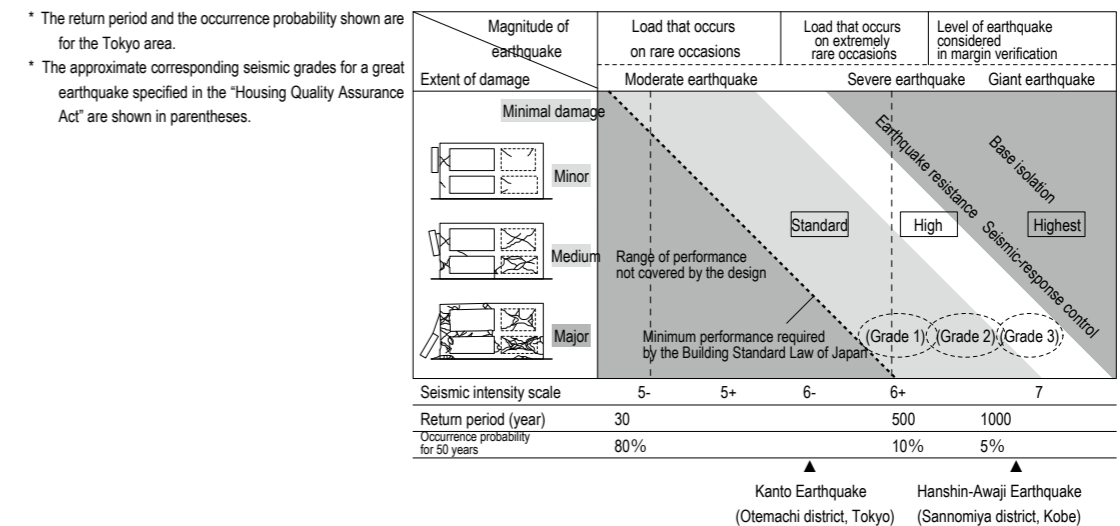

Figure 2. Relationship between earthquake resistance grade of buildings and damage/extent of repairs<sup>1)</sup>

Classification of states	Damage limit		Safety limit		
	Functions are secured No damage Repairs are not required	Main functions are secured Minimal damage Minimal repairs are required	Designated functions are secured Minor damage Minor repairs are required	Limited functions are secured Medium damage Moderate repairs are required	Human lives are protected Major damage Major repairs are required
Extent of maintaining functions	Function as a building is almost completely maintained.	Functions for executing main works are secured.	Pre-designated functions for maintaining basic activities are secured, and the building can be used as a place for disaster refuge.	Although functions for operations are lost, emergency responses including minimal emergency activities are possible in a limited area.	Though human lives are protected at the time of an earthquake, entry into the building after the earthquake is dangerous, and emergency response activities become impossible.
Extent of damage	•No deformation to the structural frame. •Although part of finishing materials, etc. may suffer minimal damage, other parts suffer no damage.	•Almost no deformation to the structural frame, and the structural strength is not affected. •Although finishing materials, etc. suffer minor damage, usability is not impaired.	•Although some residual deformation occurs to the structural frame, and earthquake resistance slightly decreases, the building resists aftershocks. •Finishing materials, etc. suffer some damage.	•Although the structural frame maintains its vertical load carrying capacity, any deformation which affects the structural strength remains. •Although finishing materials, etc. suffer considerable damage, they do not drop off.	•Although the structural frame suffers major damage, it does not cause dropping or collapse of floors. However, the risk of collapse from aftershocks remains. •Finishing materials, etc. suffer extensive damage and dropping off.
Extent of required repairs	•No repairs to the structural frame are required. •Repair of finishing materials, etc. for cosmetic appearances may be required.	•Repairs to the structural frame for securing strength are not required. •With minimal repair of finishing materials, etc., the functions can almost be completely recovered.	•Structural frame does not require immediate reinforcement/repair. •With minor repairs original functions are almost completely recovered.	•Emergency reinforcement/repair to recover the loss of strength is required. •With moderate repairs original functions are almost completely recovered.	•Complete recovery of structural frame becomes difficult. •Although operations can be resumed with major reinforcement/repair, complete recovery of original functions is difficult.

Table 1. Table of states of buildings corresponding to seismic loads1)

Magnitude of earthquake/grade	Ordinary load	Load that occurs on rare occasions	Load that occurs on extremely rare occasions	Examples of applied building use
Highest grade		Functions are secured No damage Repairs are not required	Main functions are secured Minimal damage Minimal repairs are required	Disaster prevention base, disaster base hospital, etc.
High grade		Functions are secured No damage No repairs are required	Designated functions are secured Minor damage Minor repairs are required	Ordinary hospital, refuge facility, computer center, headquarter facility, facility used by general public, etc.
Standard grade		Functions are secured No damage Repairs are not required	Human lives are protected Limited functions are secured Moderate to major damage Moderate to major repairs are required	Ordinary building

Table 2. Table of performance menu corresponding to seismic loads1)

## 5-5 Ensuring consistency among the earthquake resistance performance of building elements: structural frame, non-structural building elements, and building equipment

When a great earthquake occurs, a part of a building suffers damage. Seismic motion propagates from the ground to the building, affects the finishing materials which constitute a space as well as building equipment, and shakes furniture as well as objects. Residents will vary from infants to the elderly and their ability to respond to shaking will vary. To accommodate all these different factors, provisions against earthquakes need to be comprehensive.

### Comprehensive earthquake resistance

Even when the structural frame has no damage, the building cannot be used if the water supply has stopped and ceiling panels have fallen down. The earthquake resistance performance of a building is determined by the weakest part of the building. If this part is corrected, a higher level of earthquake resistance performance will be ensured. However, there is not enough engineering information available for studying the earthquake resistance performance of those elements which constitute a building. In the Great Hanshin-Awaji Earthquake and subsequent major earthquakes, it was observed that elevators stopped with a seismic intensity of 4, walls made of gypsum lining fell down with a seismic intensity of 5 lower, and walls and ceilings directly finished with mortar were severely damaged with a seismic intensity of 6 lower. The earthquake resistance performance of building equipment is mostly determined by the mounting arrangements. In this way, even when the structural frame has no damage, the building cannot be used if other building elements have been damaged.

### Earthquake resistance performance of interior and exterior finishing materials

The damage that interior and exterior finishing materials suffer from earthquakes vary from no damage to major damage depending on the acceleration and velocity of the motions, as well as the relative story displacements of the structural frames. Just to be capable of protecting human lives is no longer enough for the earthquake resistance performance of a building. The intensity of an earthquake that makes the building cease to function properly determines the earthquake resistance performance of the building.

The Hyogoken-Nanbu Earthquake caused enormous damage to interior and exterior finishing materials, but their removal and repair was quickly carried out because post-disaster restoration was prioritized. Therefore, only the general outline of actual damage could be grasped. Although great earthquakes have occurred again, information available for design has not been organized very well.

### Earthquake resistant-design of interior and exterior finishing materials

The 1978 Miyagi Earthquake resulted in the publishing of "Recommendations for Aseismic Design and Construction of Nonstructural Elements" in 1985 by the Architectural Institute of Japan, and it was revised in 2003 after the Hyogoken-Nanbu Earthquake of 1995. However, even after, Kushiro Airport affected by the 2003 Hokkaido Earthquake and Ibaraki Airport by the Tohoku Earthquake suffered the falling of ceiling materials and were closed for long periods. The state regards the

situation seriously, and is considering investigation into the cause and the development of countermeasures.

### Seismic damage of building equipment

Before the 1978 Miyagi Earthquake, earthquakes did not cause significant damage to building equipment, but only partial damage. However, in the 1978 Miyagi Earthquake, tremendous damage including that of building equipment and piping occurred. Since building equipment was growing in importance at that time, the earthquake resistance of building equipment became a major issue. Equipment (elevated water tank, cooling tower, machine for elevator, etc.) on the top floors and penthouses were overturned or moved. After this earthquake, "Recommendations for Aseismic Design and Construction of Building Equipment" of 1980 was published by a group of equipment-related organizations, and "Revised Seismic Design Method" was established in 1981. "Recommendations for Aseismic Design and Construction of Building Equipment" of 1982 requires: (1) Building equipment does not fall down, overturn, or move at the time of great seismic motion, and (2) It suffers no damage at the time of medium seismic motion and is able to resume normal operation after an inspection.

NPO Japan Aseismic Safety Organization sets earthquake resistance levels of building equipment as below.

### Earthquake resistance levels of building equipment

(1)Earthquake resistance level A:

- The safety of human lives is secured, and secondary damage is prevented at the time of great seismic motion (seismic intensity of 6 upper or more).
- Equipment and piping suffer no damage at the time of medium seismic motion (seismic intensity of 5 upper to 6 lower).
- Subject facility: skyscraper (office/condominium), facility that should maintain functions after an earthquake (disaster prevention shelter base, etc.), and a facility that has difficulty concerning evacuation (high-rise office or hotel).

(2)Earthquake resistance level B:

- The safety of human lives is secured, and secondary damage is prevented at the time of great seismic motion.
- Equipment and piping suffer no damage at the time of medium seismic motion.
- Subject facility: facility that is not applicable to earthquake resistance level A.

(3)Earthquake resistance level C:

- Although equipment and piping may suffer some damage at the time of great seismic motion, seismic countermeasures are quickly taken.
- Equipment and piping suffer partial damage at the time of medium seismic motion.

### Earthquake resistance levels of non-structural building elements

Earthquake resistance levels of non-structural building elements vary depending on construction conditions, any building deterioration, and their position when in use.

Since the Great East Japan Earthquake, efforts concerning the earthquake resistance of non-structural building elements by the state, institutes, and structural engineers' groups have been made. Meaningful results from these efforts are expected.

Table 1 shows rearranged damage situations observed at the Great Hanshin-Awaji Earthquake and subsequent

disasters. The vertical axis indicates building elements, and horizontal axis indicates the seismic intensity. (Junichi Nakata)

Seismic intensity		Earthquake resistance performance level	5 lower	5 upper	6 lower	6 upper	7	
			Building with low earthquake resistance suffers breaking of walls and columns	Building with low earthquake resistance collapses				
Non-structural building element	Building with low earthquake resistance suffers cracks in walls	Building with high earthquake resistance suffers large cracks in walls, beams, and columns	Building with high earthquake resistance suffers large cracks in walls, beams, and columns	Building with high earthquake resistance suffers breaking of walls and columns				
		Building with high earthquake resistance suffers cracks in walls	Building with high earthquake resistance suffers breaking of walls and columns	Building with high earthquake resistance leans or collapses				
Exterior	Curtain wall	Independent PC panel	A, B	No damage	No damage	a	b	b
		PC spandrel	B, C	No damage	a	b	c	c
Metal panel		A, B	No damage	No damage	a	b	b	
Metal-framed glass		A, B	No damage	No damage	a	b	b	
Glass screen of large floor height		B, C	a	b	b	c	c	
Corner		B, C	a	b	b	c	c	
PC fastener		A, B	No damage	No damage	a	b	c	
Relative story displacement: 1/300 no damage 1/200 repair of sealing only 1/150-1/120 element does not fall off			0					
Sash		Putty type	D	b	c			
		Fixed window	B, C	No damage	a	b	c	c
	Lateral multiple window	C	a	b	c	c	c	
	Movable window	A, B	No damage	No damage	a	b	c	
Door	Glass block	Corner, curved part	B, C	No damage	a	b	c	c
		Before 1975	C	a	b	c	c	
Direct finish	Panel type	A, B	No damage	No damage	a	b	c	
	Concrete substrate & mortar	C	a	b	c	c	c	
Stone	Concrete substrate & tile	C	a	b	c	c	c	
	Stone: wet method	C	a	b	c	c	c	
ALC	Stone: dry method	B, C	No damage	a	b	c	c	
	Finish of PC	A, B	No damage	No damage	a	b	c	
Wet construction method: lath sheet & mortar	Before 1981	C	a	b	c	c	c	
	Rebar insertion construction	B, C	No damage	a	b	c	c	
Exterior stairs	Slide and locking construction	A, B	No damage	No damage	a	b	c	
	Interior shaft and stairs	B, C	a	b	b	c	c	
Fire escape stairs	Interior shaft and stairs	C	a	b	c	c	c	
	Self-lifting	D	b	c				
Expansion	Points of attention for exterior stairs	Anchors should be given an adequate allowance (there were some cases in which anchor bolts came off and the stairs were overturned)						
	Points of attention for expansion fitting	Fitting should be arranged so that it does not fall off. Effective working width should be ensured for to allow various activities.						
Interior	Interior finish	Points of attention for interior finish	Securing excavation route, door's swing, prevention of falling off, securing safety at the time of fire.					
		Points of attention for the objects placed on the floor	Friction of floor: it affects those objects placed on the floor. Objects should be directly fixed to structural frames.					
Floor	Access floor	B, C	No damage	a	b	c	c	
	Concrete substrate & mortar	C	a	b	c	c	c	
Wall: direct finish	Concrete substrate & plaster	C	a	b	c	c	c	
	Concrete substrate & tile	C	a	b	c	c	c	
Installing stone veneers	Opening	C	a	b	c	c	c	
	Closed joint	C	a	b	c	c	c	
Partition wall, LG substrate (ordinary finish)	LG substrate (ordinary finish)	C	No damage	a	b	c	c	
	Screws for board mounting @ 225-300 mm	A, B	No damage	No damage	a	b	c	
GL construction	Earthquake resistant construction wall, relative story displacement 1/50 (joint part: ensure clearance of the displacement)	A, B	No damage	No damage	a	b	c	
	GL construction	D, C	b	c	c	c	c	
Glass partition	Lateral multiple window	A, B	No damage	No damage	a	b	c	
	Movable partition wall	C	a	b	c	c	c	
Ceiling	Direct finish	A, B	No damage	No damage	a	b	c	
	Wood substrate ceiling	A, B	No damage	No damage	a	b	c	
System ceiling, T-type	LG substrate ceiling	B, C	a	b	c	c	c	
	System ceiling, H-type	C	b	c	c	c	c	
Door	System ceiling, H-type	A, B	No damage	a	b	c	c	
	Brace, 1/30-40 m2	A, B	No damage	No damage	a	b	c	
Non-structural wall installed	Non-structural wall installed	C	a	b	c	c	c	
	Earthquake resistant door, relative story displacement 1/120	B, C	No damage	a	b	c	c	

Earthquake resistance performance level A: Although building elements suffer some damage, functions are secured.  
 Earthquake resistance performance level B: Although building elements move and suffer damage such as cracks, they show no sign of breaking or falling off. Functions are not secured.  
 Earthquake resistance performance level C: Building elements break or fall off. Safety of human lives is not secured.  
 Damage level a: Although building elements suffer some damage, they function (minor damage).  
 Damage level b: Building elements suffer damage and do not function well (moderate damage).  
 Damage level c: Building elements suffer serious damage and do not function at all (major damage).

Table 1. Earthquake resistance level of non-structural building element by element  
 Non-structural building elements, which are independent of the structural frame, do not have any strength because they are not a structural element.

## Issues by building use

## (1) Apartment buildings

The Great Hanshin-Awaji Earthquake directly hit urban areas, and many apartment houses built to old earthquake resistant standards suffered great damage. In contrast, at the time of the Great East Japan Earthquake, mid- to high-rise RC apartment buildings suffered less tsunami damage, and protected many residents who evacuated to their roofs. Pilotis-style apartment buildings especially, offered no resistance and allowed the giant tsunami to flow through, thus limiting the damage from scouring.

## Damage of newly-built high-rise condominiums from earthquake

At the time of the Tohoku Earthquake on March 11, 2011, quakes with a seismic intensity of 4 to 5 were observed in the Tokyo-Yokohama area. Although mid- to low-rise apartment buildings suffered little damage, newly-built high-rise and super-high-rise apartment buildings suffered greater damage.

Cracks due to deformation occurred in the structural frame of those high-rise and super-high-rise apartment buildings built with super-high-strength concrete. The party walls of apartments and passages made with overlapped boards on light gauge steel structures jarred against each other, and the boards broke or cracked, and fabric peeled from walls at the moment of the earthquake. Moreover, some fire doors on fire escape stairways were difficult to open and close, and some accidents resulted in the need to replace sashes. Restoration work of the non-structural building elements of a super-high-rise condominium often costs more than 100 million yen per building.

Falling of tiles and finishing materials around earthquake-resistance slits made for absorbing displacements, and the dropping of expansion joint hardware were observed in many high-rise condominiums. These accidents seem to have occurred due to an elementary lack of attention resulting from a failure to exchange information between architects and structural engineers.

There is a need to ensure less building deformation, and to reconsider the detailed design of joint parts between non-structural building elements and structural frames.

## Giant tsunamis and apartment buildings

At those areas severely stricken by the tsunami including



Figure 1. An apartment building on the coast of Rikuzentakata

The structural frame suffered no damage because the tsunami rose to the 5th floor and flowed through the building. Sashes and balustrades of the 1st and 2nd floor balconies were washed away, sashes of the 3rd and 4th floor remained but their glass was smashed, and the 5th floor sashes, balcony glass and balustrades remained intact.

Minamisanriku-cho, Rikuzentakata City, and Onagawa-cho, all the wooden houses were wrecked and washed away, only leaving the RC apartment buildings. The resistance properties of mid-rise apartment buildings against tsunami were much greater than wooden or steel frame buildings, and these buildings played a role as tsunami refuge

buildings.

Even when the wooden houses had been designed based on standards for earthquake resistant design set after 1981, they offered little resistance against the tsunami, and were reduced to rubble.

Regarding the damage to RC apartment buildings caused by the tsunami, glass, sash, and metal balustrades up to the height of the tsunami's run-up were all broken, but when a tsunami flowed into the building and out onto the mountain side, the structural frame escaped any damage, although the interior finishes were severely affected. When leading waves and backwashes repeated, some pile foundations were exposed due to scouring of the surrounding ground, but even so, the building did not overturn.

If the run-up height of a tsunami exceeds the building height, the building overturns due to buoyancy, and is unable to protect human lives and act as a tsunami refuge building.

## Apartment buildings in waterfront areas

The apartment buildings located in the waterfront of the Tokyo-Yokohama area and coastal cities in West Japan require countermeasures against tsunami.

- (1)The building height should be two stories higher than the runup height of a tsunami. This height prevents overturning due to the uplift of the building and protects human lives.
- (2)Two way escape routes to the ground are required. In addition, as a countermeasure against tsunamis, escape routes to the upper floors and roof must be secured.
- (3)Equipment functions should be secured by placing machine rooms for power substations, in-house power generators, water tanks, etc. on upper floors, avoiding the basement, which has a risk of flooding.
- (4)After the Great Hanshin-Awaji Earthquake, it was claimed that a pilotis-style apartment building has a problem in earthquake resistance. In reality, they are highly earthquake-resistant and very effective against tsunamis. They avoid damage to their foundations from scouring by letting the tsunami flow through, thus limiting damage to the building.
- (5)A building with high security functions including an automatic locking system is likely to prevent escaping, and such security functions need to be deactivated at the time of a disaster.

## Promotion of seismic diagnosis and seismic strengthening

The promotion of earthquake-proof conversion of apartment buildings designed based on old earthquake resistant design standards is sluggish. Condominiums have difficulty in residents establishing a building consensus. For small steel frame apartment buildings the cost for inspection of fire resistant covering including asbestos is excessive, and the cost is simply too great for the owners of small apartment buildings to defray.

(Tetsu Miki)

## References

- 1) Committee on Building Maintenance, JIA, A photograph collection of the Great Hanshin earthquake: Hisaishita shugo jutaku (affected apartment buildings), Tetsuado Shuppan, 1995
- 2) A photograph collection: 3.11 Heisei tsunami to shugo jutaku (3.11 Heisei tsunami and apartment buildings), JASO (Japan Aseismic Safety Organization), Tetsuado Shuppan, 2011 Aseismic Safety Organization, Tetsuado Shuppan, 2

## Issues by building use

## (2) Super-high-rise apartment building

A super-high-rise apartment building is a form of mini-compact city incorporating a very high level of environment-friendly and disaster prevention measures, and about 90% of such structures have adopted RC construction because of its effectiveness in the prevention of wind vibration, good sound insulation, and the virtues of its structural frame. It is a safe building form that is prepared for earthquakes with earthquake resistance, vibration control, base isolation, etc. It aims to show architecture as creating a social infrastructure for a sustainable society, by adapting to the demands of an aging society, extending a building's life, and by using green power.

## Super-high-rise apartment buildings as a mini-compact city

Approximately 73% (about 5.4 billion m<sup>2</sup>) of the total floor area of all buildings in Japan (about 7.4 billion m<sup>2</sup>) is for residential use, and about 95% of the residential floor area is in the form of detached houses and about 5% (about 0.3 billion m<sup>2</sup>) is apartments. The energy used for heating by residential use accounts for approximately 30% of Japan's annual energy consumption. However, when a super-high-rise apartment building complying with "next generation energy conservation standards" is surveyed, heating costs are reduced by heat insulation between apartments and floors; the total building area can be minimized, allowing the rest of the site to be used as green space, and overall the structure has a great effect on mitigating the environmental load. All these factors justify a super-high-rise apartment building being described as a mini-compact city.

## Basic performance of super-high-rise apartment buildings

A super-high-rise building is designed with a structural analysis that assumes a giant earthquake, and it is assessed as a high-rise building. Therefore, it ensures high earthquake resistance performance in the sense that it does not collapse. Regarding a tsunami, the affected part of the tower-shaped building is limited to the lower part, and damage is likely to remain minimal. In contrast, imagine the structure laid along the ground and the area of building subject to wave forces increases dramatically with a resultant expansion of destruction.

Being highly earthquake-resistant, having many upper floors that are not likely to suffer tsunami damage, and being equipped with such basic performance, including a fire extinguishing system (fire correspondence), lighting arrester equipment (lighting correspondence), and water and air tightness (storm correspondence), it can be said that a super-high-rise apartment building is a safe building form that is resistant to natural disasters, meaning that it can protect human lives.

In addition, by establishing room sizes and layouts, as well as by preparing manuals and systems for disaster prevention, the maintenance of functions and continuation of livelihoods are ensured during and after an earthquake.

## Earthquake resistance &lt; vibration control &lt; base isolation

Because shaking of a building is amplified when a natural period matches a seismic wave (period), damage is uniform. Adoption of RC construction makes the natural period of a

building relatively shorter, and gives the advantage to countermeasures against long-period earthquakes. It is also effective in terms of ensuring habitability against wind vibration and good sound insulation between floors, and possesses the virtues of a structural frame.

However, based on the fact that the structural frames of many high-rise buildings suffered severe damage in the Great East Japan Earthquake, efforts need to be made to minimize the damage to structural frames by effective measures including adopting a seismic-response controlled structure and a seismically isolated structure in relation to building locations and ground characteristics. In addition, from the perspective of protecting human lives and securing safety in an apartment, the importance of not only earthquake resistance performance, but also simple measures to prevent the overturning of furniture must be remembered.

## Toward a sustainable society

Urban redevelopment is an important means of incorporating urban disaster prevention into the fabric of society. In order to restore open and green spaces in city centers while assuring continuation of livelihood, verticalization of housing becomes necessary.

Although elevators as a means of vertical transportation have been seen as a problem, especially since the Great East Japan Earthquake, by upgrading the earthquake resistant specification of elevator equipment (from A to S), problems and unintended stopping of elevators can be prevented, as well as recovery made easier. It is also important at the time of an earthquake to consider enabling conversion from the "ordinary function" of an elevator to an "emergency function" by connecting part of the elevators for ordinary use to an emergency generator or green power source. In recent years, the SI (skeleton-infill separation) system has been increasingly implemented to allow the future upgrade of equipment, clarification of space control division, and the extension of a building's life from the perspective of the reduction of maintenance and repair costs. It is desirable that efforts toward a sustainable society, based on the coming super-aging of society are increased, including environmental considerations, disaster prevention countermeasures, and extension of a building's life by means of technological innovation.

(Yoshifumi Abe)



Figure 1. Example of super-high-rise apartment building that adopted a seismically isolated structure (Type 1 urban redevelopment project in Minamikebukuro 2-chome District A: Designed by Nihon Sekkei, Supervised by Ken-go Kuma and Tatsuya Hiraga, Perspective drawing by Nihon Sekkei)

**(3) Schools**

In the aftermath of the Great Hanshin-Awaji Earthquake and Great East Japan Earthquake, schools played a very important role as a disaster base for the community. Gymnasiums especially were used as a primary place for a long-term disaster refuge, and it is apparent that the function of a school in a community was reevaluated.

**Points to note concerning school buildings**

A school is the most common public building; for example, 80% of the buildings owned by Yokohama City are schools. Although a significant number of school buildings suffered damage in the Great East Japan Earthquake, those which had been designed based on standards for earthquake resistant design after 1981 and those which had received seismic strengthening suffered little damage. Seeing such school buildings dignified and still standing in the midst of devastation attested to their reliability. Basically, if the building is designed based on standards for earthquake resistant design set after 1981, no great problem will occur. However, the following points should be noted.

(1) Significantly long school buildings, or those with an L-shaped or T-shaped plan should be separated by expansion joints.

Especially, the crossing portion of an L-shape is prone to break due to the combination of different vibration behaviors in both the X and Y directions.

Moreover, seismic motion does not independently arrive only in the X and Y directions, it comes from every direction. At the time of the Tohoku Earthquake, maximum seismic motions of 2,700 gal in the north-south direction, 1,268 gal east-west, and 1,880 gal in a vertical direction were recorded at Tsukidate, Miyagi prefecture.

(2) A classroom building is prone to have low earthquake resistance in a longitudinal direction compared to the span direction which can have a lot of shear walls. In a longitudinal direction, it is difficult to set up shear walls, and because of spandrel walls, columns have different inside heights, which lead to stress concentrations. It is important to ensure a well-balanced layout of earthquake resisting elements, including replacing any extremely short columns with long columns by means of a slit.

(3) In the case of side corridor plans, it is structurally advantageous to make the corridor-side exterior wall a rigid frame. Although, using a cantilever form has some advantages. In this case, it is desirable to give consideration to options including giving the frame along the center line a structural allowance and reducing the weight of exterior materials.

**Points to note concerning gymnasiums**

(1) When a suspended ceiling is installed, adequate countermeasures should be taken against the falling of ceiling panels; this is often caused by the ceiling backing knocking against a wall. It is vital to increase the rigidity of ceiling backing as a whole with measures including adequate bracing (Figure 1) and strengthening jointing hangers and the backing.

(2) Regarding seismic strengthening of existing facilities, horizontal bracing of a roof is an important factor.

In many steel gymnasiums, the earthquake resistance of a gable-side frame against seismic motion in the span direction is greater than the interior frame. As a result, horizontal braces at the exterior ends are often subject to too much seismic force, and break or deform. Contrarily, by strengthening horizontal braces, the earthquake resistance performance of the whole of such a gymnasium can be improved. *(Hanji Hattori)*



Figure 1. Seismic strengthening of gymnasium. Ceiling braces were replaced.

**(4) Museums and libraries**

Because museums deal with unique and irreplaceable objects, not only protection of human lives, but also avoidance of damage to such artifacts is required.

Libraries accommodate books and their very heavy bookshelves, which should be fixed to prevent any sliding or overturning.

**Varied damage depending on an exhibition's situation**

Risk of damage varies greatly depending on the manner in which objects are displayed and placed. Movable independent display cases twitch and sporadically slide at the moment of an earthquake and mitigate the vibration. Cases along walls are mostly overturned by impulsive force caused by the motion of the wall. Fixed cases move together with the building, and exhibited objects are directly affected. As seen in the Great Hanshin-Awaji Earthquake, dotakus (bronze bell-shaped vessels from the Yayoi period) exhibited in independent cases suffered no damage, those in fixed cases overturned, and those in the cases along walls cracked due to the overturning of their cases.

**Points to note concerning floors, ceilings, etc. of exhibition rooms**

The material of the floor affects the behavior of a display case. Floors finished with hard material including P-tile (vinyl floor tile) and wood have less frictional resistance, and cases sporadically slide and twitch, but rarely overturn. On the other hand, floors finished with soft materials such as carpet have greater frictional resistance, and cases are prone to overturn.

In order to provide the necessary lighting for exhibitions, removable lighting fixtures are often installed on the ceiling, and it is absolutely essential to prevent their falling off. It is also necessary to devise means of physically fixing the louvers used for diffusing light. Exhibition rooms usually have large spaces and are equipped with ducts and lighting fixtures on the ceiling. Those ducts and fixtures have their own natural period. Therefore, at the time of an earthquake, there is some risk that they will move independently, interact, and fall off.

It sometimes happens that wire used for hanging an exhibited object breaks; it is important to select the diameter of wire taking into account impulsive force.

Movable exhibition panels are prone to greater movement than one might imagine, because the panel itself has a considerable weight (usually 2 tons), and the force needed to move it is correspondingly great; therefore, it is necessary to attach stoppers to meet the force.

It also sometimes happens that the glass panes of fixed display cases break due to resonance with long period seismic waves; this is an emerging issue, and appropriate countermeasures need to be drawn up.

**Points to note concerning storage**

Steel storage racks are disadvantageous in that they are prone to slide. A wooden storage shelf has some frictional resistance and stored objects often stay on the shelf. In the case of a map case that stores block prints, etc., drawers are prone to come out and the case overturn to the front.

Storage racks in a storage room are very heavy when paintings are hung. Therefore, it is necessary to attach stoppers that

meet the weight.

**Effectiveness of seismic isolator**

As a device for protecting museum "objects" from damage, a device which isolates "objects" from seismic motion (seismic isolator) is effective. Seismic isolation includes the following three types.

- (1) Building isolation (placed between the ground and the building)
- (2) Floor isolation (placed between double floors), and
- (3) Equipment isolation (support "object" with a device)

**Libraries**

Libraries naturally have a lot of books, and effectively accommodate them on bookshelves. The design live load for libraries is greater than ordinary buildings, and is 800 to 1,000 kg/m<sup>2</sup> for stack rooms and about 600 kg/m<sup>2</sup> for reading rooms.

**Fixation of bookshelves**

Safety protection for libraries lies in the prevention of bookshelves overturning. Tall bookshelves should be fixed to the floor at the bottom, as well as being tied to each other at the top, and consequently be fixed as a whole unit. Usually a square bar of 25 mm x 40 mm should be used for tying the tops. For fixing to the floor, M12 bolts or equivalent should be used.

**Upgrading of bookshelf earthquake resistance**

Although wooden bookshelves suffered little damage even in the areas affected by a severe earthquake, steel bookshelves suffered great damage even when they had been tied at their tops. In order to upgrade the earthquake resistance of steel bookshelves, it is effective to fasten braces or backboards, although usability would be reduced. Bookshelves along a wall must be fixed to the wall at the top. Short bookshelves should be prevented from overturning by widening the bottom and fixing to the floor; all the shelves must be fixed. Bookshelves are the main structural equipment for a library, and their safety needs to be secured.

**Others**

In the case of a map or card case with drawers, the drawers are prone to come out and the case overturns to the front.

It often happens that wheeled book racks laden with books careen freely around during an earthquake. *(Junichi Nakata)*

## (5) Hospitals

It is insufficient for the earthquake-resistant design of hospitals to only offer resistance to earthquakes and protect human lives.

Based on the building use characteristics of a hospital, the earthquake-resistant design can be defined as including the selection of medical functions required to be maintained after the earthquake, as well as planning that assumes relief activities at the time of the earthquake. The concepts and precepts to be considered for such a design task are discussed.

### Building use characteristics of hospitals

Building use characteristics that should be considered in the earthquake-resistant design of hospitals may be summarized in the following three points.

The first point is the existence of hospitalized patients, who are undergoing treatment, or for some health reason, cannot carry on normal life at home. Therefore, it is likely that they only have a limited ability to assess a disaster situation and take action, including the ability to escape via stairs at the time of the earthquake. In addition, there are patients whose lives are sustained by medical equipment, including those in intensive-care units. Therefore, disaster prevention planning should be conducted based around this group's severely limited ability to escape.

The second point is the existence of the medical equipment and supplies used in a hospital for ordinary medical activities. As anybody who has designed a hospital must notice, there are a lot of "unfixed things" in a hospital. There are all kinds of movable equipment and supplies, including beds, materials for medical care, medicines, serving carts for food, movable medical equipment, medical equipment hung from runners along ceiling rails, carts for various care treatments, and carts for terminals associated with the recent introduction of electronic health record systems. It should be assumed that all this equipment and supplies will be prone to move a lot at the time of a great earthquake and may cause a secondary disaster.

The third point is the social mission every hospital must carry out at the time of a disaster. Because there are hospitalized patients in a hospital, all hospitals are required to maintain medical functions in order to protect their lives. Therefore, it is not sufficient for the earthquake-resistant design of a hospital to ensure only the "non-collapse" of the building. Every hospital must be built with a structure and have equipment robust enough to maintain medical functions, even after a great earthquake. In addition, hospitals have to provide additional medical care for the people injured by the disaster. It is essential to include provisions for all the above factors in hospital architectural planning.

### Protection of human lives

A hospital is a facility which requires particular attention to minimize building damage from the perspective of protecting human lives, because it is accommodating many users who have low resistance against a disaster. Therefore, an addition to the importance factor and adoption of a seismically isolated structure should be proactively considered.

After the Great Hanshin-Awaji Earthquake, seismically

isolated structures have rapidly become popular, and not only public but also private hospitals have started adopting such structures. As seen in the Great East Japan Earthquake, those hospitals that had adopted seismically isolated structures not only protected human lives but also minimized damage including that to building equipment and piping as well as non-structural building elements.

When these facts are considered, in the design of a hospital, regardless of its scale, whether to adopt a seismically isolated structure should be examined at least once. Even if the structure was not chosen due to economic or technical reasons including the ground, design should be conducted from the perspective of maintaining functions after a great earthquake, including setting an importance factor of 1.25.

However, seismically isolated structures cannot completely stop the motion of a building. Actually, even a hospital that had adopted such a system suffered the overturning and falling of equipment, and could not continue its medical activities, especially on the upper floors. Regarding the prevention of such secondary disasters, technological improvement in terms of both structural technology and equipment fixing fittings will be continued.

### Continuation of medical functions

The next important point in terms of building use characteristics is the continuation of medical functions. The earthquake-resistant design of hospitals only makes sense if not only a building which can resist an earthquake is designed, but also continuation of medical functions after a great earthquake is planned.

First of all, continuation of hospital treatment is essential. It does not mean continuation of heavily-equipped functions including operations or inspections but rather to ensure an environment for medical treatment of hospitalized patients in patient's rooms, as well as the bodily functions of patients e.g. eating, excretion, etc. It is thus crucial to ensure functions for supplying food and medicine to hospital wards. Elevators play the leading part in this service, therefore, when elevators cannot be used, provision of medical treatment falls considerably. Although the safety of elevators at the time of an earthquake has been improved, restoration after an earthquake disaster requires engineers. The delay in restoration due to blockage of transportation networks in the aftermath of an earthquake revealed a significant problem of high-rise hospital buildings, which needs to be addressed. One possible solution for earthquake-resistant design, when site conditions allow, is the provision of low-rise hospitals.

Another point of attention, in terms of the continuation of medical functions is architectural support for activities to provide aid to those people injured by the disaster.

Since the Great Hanshin-Awaji Earthquake, disaster base hospitals to provide medical activities at the time of great disasters have been designated all over Japan, and standards including those for building structures, emergency equipment, and personnel frameworks have been prescribed. In addition, the disaster prevention plans of local governments have included the roles of other medical institutions at the time of a disaster. In terms of design, an adequate space for triage should be ensured because a lot of injured people are rushed to a hospital at the time of a disaster. Although it would be better if such space can be ensured inside, having a

large canopy (Figure 1) is effective because the hospital will be inundated with injured at the time of a disaster. Even when a canopy is not possible, it is necessary to secure an open space in the site.

People are classified into slightly-injured, heavily-injured, or dead and temporarily accommodated at the hospital. In preparation for such a situation, it is necessary to ensure as large a space as possible (Figure 2). For that purpose lobbies or auditoriums are often used, and there is a need to consider providing emergency power supplies and medical gases to these spaces. Considering the existence of patients who need equipment and devices such as dialysis and home oxygen, it is required to define in cooperation with the hospital the minimum equipment that should be maintained during stoppage of the infrastructure.

### Issues in tsunami disasters

At the time of the Great East Japan Earthquake, many lives were lost to the tsunami. This event clearly showed the importance of paying attention when setting the ground level and using the first floor of the hospital when designing a hospital located in an area which is prone to inundation by a tsunami and other flood disasters.

In designing a hospital, the ground floor is often regarded as the best place and functions such as outpatient medical care are located here. Moreover, hospitals have an important function of receiving ambulances, and most hospitals in Japan have located their emergency department on the ground floor except in special cases.

However, when flooding, and especially a tsunami is considered, the ground floor is obviously the most dangerous place. Actually, in the Great East Japan Earthquake, many

people survived by escaping from the ground floor to the roof. Therefore, hospitals should be designed to allow easy escape to upper floors. In that case, functions assumed to be used by those patients who cannot walk by themselves should not be located on the ground floor.

In the areas affected by the Great East Japan Earthquake, some hospitals escaped from tsunami flooding by means of earth fill. However, this cannot necessarily be considered as a standard method because such a fill requires a large area of site, which is sometimes not possible. There are some hospitals that locate emergency departments on the first floor. If flooding is thought to be likely, it is essential to prepare as much as possible, and also consider how to overcome the consequent inconvenience for staff carrying out daily tasks. The reasoning of "because it may occur once in 100 years" comes from an economic perspective, and should not be taken as the first principle by designers.

### Conclusion

Although the perspective of continuation of medical functions is becoming popular, it needs to be further explored; in the future, cases where designers are consulted, reviewing locations from the perspective of flood disaster may increase.

As all sites are different, there is no convenient catch-all answer to solve all the architectural and medical problems. Although finding an optimum solution by considering both the usual and emergency functions, location, and economic conditions is a collaborative work of designers and hospitals, helping find the path leading to a reasonable solution on optimum technological grounds will be the contribution of the designers.

(Hiroyoshi Hasegawa)



Figure 1. A large roof on pilotis designed with a triage function for use in an emergency (Ise Red Cross Hospital, Designed by Nihon Sekkei)

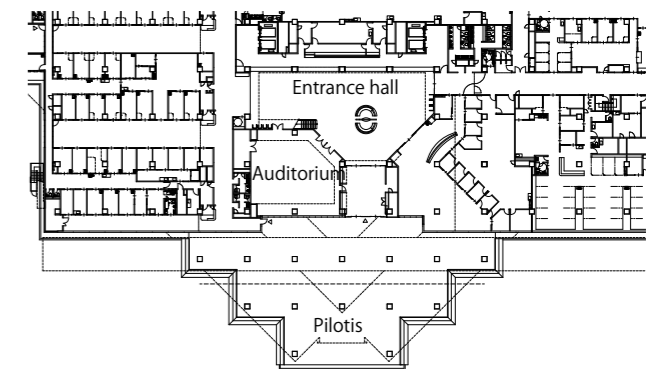

Figure 2. An example where an auditorium is located next to the entrance hall on the first floor (same as left)



Issues by building use

**(6) Halls, meeting places, and gymnasiums**

When designing facilities that accommodate the general public, including meeting facilities, securing the safety of seating space at the time of a disaster event and evacuation guidance after the event are important points. After the completion of the building, how to respond to a disaster during everyday operation of the facility is also an important factor. These facilities may be used for temporary accommodation immediately after an earthquake, and in the case of public facilities, they may be used as disaster refuge facilities during the restoration period.

**Characteristics of meeting facilities, etc.**

The characteristics of seismic safety concerning meeting facilities, including halls, meeting places and gymnasiums, where the general public gather for events, are typically represented by dense seating spaces in a hall, etc. Seats more cramped than in other facilities are set on both sides of aisles narrower than architectural standards, and longitudinal aisles are often stepped in response to the sloping tiers of the seating. When such seats are fully occupied, evacuation guidance at the time of an earthquake can be very difficult.

Therefore, at the time of a great earthquake, the safety of seating space and guidance for quick evacuation become important goals.

**Ensuring the safety of seating space**

Because the Building Standard Law of Japan does not include detailed prescriptions for the layout of seats and aisles, and adjunct facilities, design should be conducted by reference to the standards such as the Tokyo Metropolitan prefecture ordinance of building safety standards.

Planning the seating space of meeting facilities, etc. requires considerably more care than ordinary construction methods, because such spaces usually have higher ceilings than ordinary facilities, and damage of the ceiling, falling of ceiling materials from a considerable height, etc. may have a great impact and pose considerable danger.

Moreover, such facilities as halls often have a variety of equipment including stage sets, lighting and audio equipment in the seating space areas, and damage from the moving and falling of the equipment needs to be prevented.

Regarding the safety guidelines for these facilities, "Guidelines for earthquake-resistant design of ceilings of gymnasiums, etc.," "Guidelines for safety of suspended materials" (the Building Center of Japan), "Guidelines for safety of suspended machinery," "Guidelines for safety of floor machinery," "Installation standards of lighting fixtures for direction space," "Basic principles for suspending speaker systems" (Theatre and Entertainment Technology Association, Japan), etc., have been published. However, they are under review after the Great East Japan Earthquake.

**Ensuring the safety of evacuation guidance**

Seating spaces require the appropriate provision of information and evacuation guidance on the operation side because such space often has double doors for sound insulation, and for the reasons mentioned above, conditions in the aisles of the space are harder to evacuate than in ordinary facilities.

Regarding evacuation routes from the seats to a safe place,

it is important to ensure adequate room, sometimes depending on conditions, an amount of room that exceeds regulatory requirements. In addition, the positioning of equipment including lighting, broadcasting, guidance, and signs must be done in a way visitors and users can easily understand (Figure 1).

In recent years, many large-scale complex facilities with myriad functions and related facilities have been planned, and clear configuration, circulation with adequate room, and the securing of evacuation routes are becoming more important.

**Buildings used as a disaster refuge facility**

When meeting facilities, etc. are operated by local governments, they are often assumed to double-up as refuge facilities against a seismic disaster. In such cases, the space and equipment required for such use needs to be configured and set up.

In addition, the problem of commuters unable to return home as seen in the Great East Japan Earthquake indicates that it is necessary for local governments and private institutions who operate meeting facilities to consider and prepare for the use of such facilities as temporary accommodation.

(Mamoru Kikuchi)

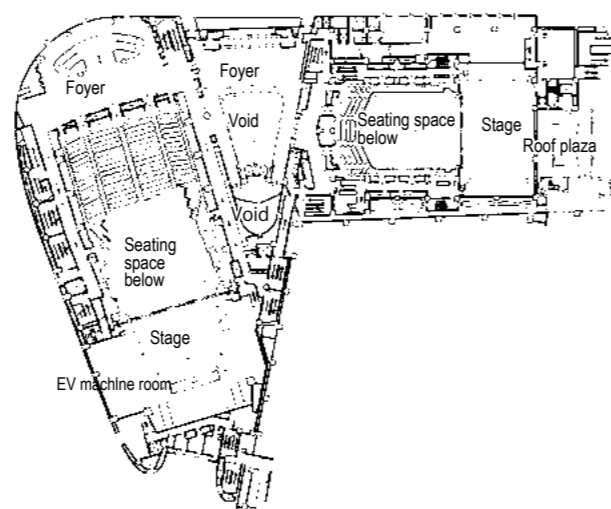

Figure 1. An example of a hall where a wellhole has been surrounded by an exterior corridor in the center of an evacuation route for the whole facility (Bunkamura, Designed by Ishimoto Architectural & Engineering Firm, MIDI Sogo Sekkei, and Tokyu Architects & Engineers)

Issues by building use

**(7) City hall**

The goal of designing a local government office is to ensure that it can be used as a base for emergency response activities against a disaster, even immediately after an earthquake. In the process of restoration after an earthquake, it is desirable that the local government office can continue to offer ordinary administrative operations. It is therefore necessary to make the local government office a facility that can ensure all these functions against any foreseeable disaster that may occur at its location.

**Role of local government at the time of a disaster**

Local government is designated to play an important role in an emergency response against a disaster. Emergency response activities against disaster provided by local governments can be broadly divided into an initial response period and a restoration period as follows.

**1. Initial response period**

- 1) Setting up headquarters for disaster control
- 2) Establishing communication systems and collecting information
- 3) Initial public relations and requests for support
- 4) Fire-fighting, rescue, and security
- 5) Medical aid
- 6) Evacuation guidance
- 7) Prevention of secondary disaster
- 8) Ensuring shipping and transportation
- 9) Countermeasures for commuters unable to return home

**2. Restoration period**

- 1) Operation of a place as a disaster refuge
- 2) Collecting information and public relations
- 3) Supplying drinkable water, food, and necessities of life
- 4) Health and hygiene activities
- 5) Ensuring safety for vulnerable people
- 6) Handling of missing people and dead bodies
- 7) Countermeasures for garbage, human waste, and rubble
- 8) Countermeasures for buildings and emergency housing
- 9) Emergency restoration of utilities and public facilities
- 10) Emergency education and childcare
- 11) Application of laws for disaster emergency

Local government offices must not only be facilities that can smoothly implement these activities at the time of a disaster, but also should be able to resume ordinary operation during any restoration period.

**Earthquake resistant safety standards for government facilities**

The basic policy on earthquake resistant safety standards for government facilities is presented in "The Standards concerned with Location, Scale and Structure of the Government Buildings and Their Ancillary Facilities" (1994) that was prepared by the Ministry of Land, Infrastructure, Transport and Tourism. Based on this policy, each facility should be planned in accordance with the "Comprehensive seismic planning standards for government buildings" (1996), and existing facilities should be renovated in accordance with the "Comprehensive seismic diagnosis/renovation standards for government buildings" (1996).

The "Comprehensive seismic planning standards for government buildings" requires "a room as a base for implement-

ing emergency response activities" and "a room and passage, etc. that is required to ensure its function" (local disaster control center, etc.) to follow a high level of Category I, Category A, 1st Category in Table 1 of section 5-3, and that these facilities should be planned to be usable without undermining their functions at the time of a disaster.

**Earthquake resistant safety standards for local government offices**

Based on the above standards, local government offices should follow design conditions for Category II, Category A, 1st Category and upper. However, when they include a room as a base for an emergency response, etc. such as a local disaster control center, etc., the structure of such a part or the whole structure should follow the conditions for Category I.

**Location of local government offices**

In addition to these design conditions for individual facilities, local government offices need to be designed so that they can respond to the different types of disaster that are expected at the location of the office; in addition the location itself needs to be reviewed. Especially, as the tsunami disaster caused by the Great East Japan Earthquake clearly indicates, preparing countermeasures against foreseen tsunami at the locations of local government offices along coasts is becoming an important issue (Figure 1).

(Mamoru Kikuchi)



Figure 1. Kamaishi City Hall in Iwate prefecture, being built on a relatively high place, was partially flooded, but soon recovered to continue functioning as a local government office.

Issues by building use

**(8) Local disaster control centers**

In designing a local disaster control center, an importance level of earthquake resistant performance of 3 should be adopted, and the location of the site and site plan should be carefully studied, as this is a public facility to be a disaster base, the ensuring of water and electricity as well as communication networks is critical.

**Base for activities at the time of a disaster**

A local disaster control center is a facility which is required to be free from damage even when the buildings in the surrounding areas suffer damage. It must then go on to act as a function to support evacuation and rescue activities. Therefore, the facility is required to have an earthquake resistant performance of level 3 for non-structural building elements and level 3 to 4 for building equipment.

Although the facility is basically not operated at ordinary times, it is desirable to be maintained by periodic inspection and maintenance as well as the holding of emergency drills, and it must be ready for operation at any time.

**Selection of the site**

The site of a local disaster control center should be selected, so that it can provide superior functioning; to meet this requirement any potentially dangerous areas in terms of disaster prevention including areas of potential liquefaction, cliffs, and tsunami hazard areas should be avoided. When there is no choice but to build in a tsunami hazard area, the building should be higher than the maximum tsunami height expected in that area and have a reinforced concrete structure. If the building is relocated to a higher elevation, it is desirable to avoid filled ground and build on an area of cut ground. In addition, the site should be a place where activities can be carried on in cooperation with other administrative agencies including prefectural government, municipal government, fire department, and police. It is also desirable that it is located near local government facilities or parks, as well as facing a main road of adequate width.

**Site plan**

The building should be built with a noncombustible construction and protected from the spread of fire by being kept at a safe effective distance from adjacent buildings. The facility should be designed so that it ensures sufficient space for disaster prevention activities at the time of the disaster, in addition to parking space for ordinary times, and also enable vehicles engaged in disaster prevention activities to preferentially function by providing an open space, facing a main road, where these vehicles can enter and easily turn around.

**Securing communication networks**

A disaster control center requires communication networks that can continue to function to collect and transmit information even in the event of a disaster. It is necessary to ensure alternative means, in the case of a break of ordinary telephone lines. It is also necessary to ensure communication networks and design the building with consideration of a higher design seismic coefficient because it accommodates important equipment including wireless and computer equipment, telephone exchanges, mobile base station, optical line and

communication, IP phone equipment, etc.

**Securing water and electricity**

The stockpiling of water should be determined by considering the needs for drinking, sanitation, and equipment operation critical to fire protection activities. Reservoirs for drinking water should be placed above the floor, and consideration to emergency shutoff valves and joints should be given. Electricity should be ensured considering the needs for disaster control activities including lighting, water supply, drainage, communication equipment, air-conditioning, disaster prevention equipment, and the operation of critical equipment. The period estimated for the requiring of such water and electricity should be set longer than the period until the public water supply and commercial electric power supply are likely to be restored.

**Provisions for utility problems**

Preparing for an unforeseen accident, alternative means of utility systems equipment are required, including dual entry of electricity, power generating equipment (air-cooled type), wells for disaster prevention, water supply facilities, regulating reservoirs for water supplies, drainage, and disaster prevention, dual line water supply, drinkable water filtration sterilization equipment, and emergency water-supplying ports.

**Provision of emergency stockpiles**

It is desirable to set up warehouses that store the needed amounts of ordinary emergency stockpiles. More than three days' worth of drinkable water, food, etc. are required. In addition, in the case of a local disaster control center, a greater amount of heavy oil, etc. for emergency power generating equipment than for an ordinary facility should be secured, and it is desirable to prepare a hazardous-material depot.

(Takashi Hirai and Takahiro Kishizaki)



Figure 1. Whole of the disaster prevention building of Minamisanriku-cho, a 3-story steel frame building, was flooded by the tsunami and all of the ALC exterior walls and interior finishes were washed away. Only a few people who climbed a steel tower on the roof and were subjected to repeated tsunamis and snowing overnight survived.

Issues by building use

**(9) Hotels**

A hotel is a highly public facility, and its importance level of earthquake resistance is high. It requires design techniques that can harmonize structures between guestroom floors and lower floors. After the Great East Japan Earthquake, hotels provided food and shelter to many commuters unable to return home.

**A hotel is highly public in terms of both tangible and intangible features for earthquake resistance measures**

There are three main categories of hotel, business, urban and resort hotels. Taking urban hotels, as representative of hotels in general, a hotel is a complex building that includes guestrooms, banquet and meeting halls and rooms, restaurants, shops, and sports facilities. In large-scale urban development projects, hotels are often included as one of the projects' building uses.

Hotels can play an important role in the immediate and long-term aftermath of an earthquake, and offer a space for refuge, rescue, and restoration. A hotel therefore requires the maintaining of its functions and their early restoration. Hotels not only in affected areas but also in surrounding areas should play a role as a base for support. Therefore, a hotel is a highly public facility in terms of both tangible and intangible features, and its importance level of earthquake resistance is high.

**Combination of guestroom and common areas is important in design**

Hotels often consist of upper floors that principally include guestrooms and lower floors that basically include common space such as a lobby, banquet and conference rooms, and restaurants. Because the design of guestrooms forms a characteristic of the hotel, this part is studied at a detailed scale from the preliminary design stage. Basic spans are also determined here. On the other hand, the overall configuration of the building becomes an issue in the design of lower floors because large spaces are required. It is necessary to harmonize function and structural rationality by studying whether to place or displace upper floors over upper floors. When upper floors are placed over lower floors, structural issues occur because disparate spaces are arranged one above the other. It is difficult to position and carry through all the spans and shear walls of guestroom floors to the lower floors. There is a need to maintain the rigidity of the building as a whole, while reducing the columns and shear walls. The style of placing upper floors on widespread lower floors makes seismic input to the higher part of the building greater. Therefore, there is a need to consider how to reduce such input by design.

**Resort hotels require study of terrain and ground**

Resort hotels are often located in mountainous or seaside areas of scenic beauty; unfortunately such locations are prone to disasters. It is necessary to carefully study the location before designing a resort hotel. In the past, there were a number of earthquakes that caused great tsunamis and many people died despite the focus being distant and the seismic energy not very great. Therefore, based on history, self-sustainable countermeasures should be adequately prepared, including evacuation drills, securing the means of emergency communi-

cation, and the stockpiling of equipment, food and medicine.

**Intangible measures including computers and evacuation drills are also important**

Hotels are used by the Japanese general public and foreign visitors, and many users do not understand or read the Japanese language. Hotels are clearly specified as evacuation facilities in Italy, a popular tourism-based country. To make this possible, we must ensure not only tangible earthquake resistance performance, but also intangible countermeasures for earthquake resistance, including maintaining accurate hotel registers, computer systems, provision of stockpiled food and supplies, and periodic evacuation drills.

(Narifumi Murao and Kazuo Adachi)



Figure 1. Some hotels in affected areas continued to function. A hotel on a hill in Kesennuma, Miyagi prefecture escaped the tsunami, and was used as a base for news media and restoration workers.



Figure 2. Many urban hotels functioned. In the aftermath of the Great East Japan Earthquake, many urban hotels in Tokyo provided shelter, food and blankets to commuters unable to return home.

**(10) Location of a disaster refuge**

A disaster refuge is a public facility in the community where a large indoor space with daylight and natural ventilation is available, where many residents can stay after an earthquake disaster, and where effective open space is provided for the vehicles needed for rescue activity to park. It is desirable that the facility has rooms for information collection and transmission, emergency stockpile warehouses, rooms for the administrative functions of local government, medical staff, and the reception of volunteers.

**What is a disaster refuge?**

A disaster refuge is a public facility established in every district where local residents can stay temporarily or for a medium term at the time of a disaster. An importance level of earthquake resistance performance of 3 or more is required for the facility in order to maintain its performance without suffering damage from a great earthquake. At the same time, the facility should have an area of open space such as a plaza or a playground; in the main, this means schools, district centers, and public gymnasiums are used for this purpose. Just as a building used as a polling booth in a community is well-known by residents, so too should the location of a disaster refuge be as equally well known.

**Effective open space and available rooms are required**

The location chosen as a disaster refuge must have an effective open space which ensures an adequate distance from adjacent buildings to primarily protect against fire, and secondarily provide space for portable toilets and temporary kitchens, etc., and space for the parking and movement of any rescue transportation.

These facilities must not only be able to function as a temporary place for disaster refuge, but also maintain the functions of a rescue center and an aid center. It is important that they are equipped with wells and warehouses allocated for use in a disaster and which are maintained on a routine basis. In addition, from a medium term perspective, the open space will be used as a site for temporary dwellings. Therefore, consideration of the utilities for such dwellings should be taken.

Moreover, it is desirable that a disaster refuge has rooms available to act as offices, waiting rooms and rest stations for volunteers who support the facility and administrative staff who direct them, as well as medical examination rooms with treatment rooms, waiting rooms, offices, etc. for those aid and medical staff required for maintaining the health of any evacuees. It is also desirable that the facility is equipped with rooms to store relief supplies and food.

**Large space, natural lighting, and natural ventilation**

A disaster refuge, where many people temporarily stay, requires a large space such as a gymnasium. An enclosed space, even if it is large, cannot be used because easy lighting and good ventilation are essential. A building with good natural daylight and ventilation could be ideal as a disaster refuge.

Although exhibition halls, event halls, civic halls, etc. all have areas of large space, they are basically enclosed, and are difficult to open up for the provision of daylight or natural ventilation. Therefore, usually they are not appropriate as the

location of a disaster refuge in the medium term. However, when they are newly designed, they should be designed and built to be able to adapt and carry out the function of a disaster refuge. From experience gained in the Great Hanshin-Awaji Earthquake, it has become common practice that school facilities such as gymnasiums are used to locate disaster refuges while classrooms are retained as education facilities. Many municipalities put this idea into practice after the Great East Japan Earthquake. However, schools in the low lying areas of the Sanriku region that were hit by the tsunami could not be used as disaster refuges; only those schools built on hills could play such a role. At areas along ria coastlines, which have little flat land and are mostly undeveloped mountain forest, it was difficult to find land suitable for disaster refuges or for temporary dwellings. This is an issue to be tackled in the future.

**Public facilities of the future should function as disaster refuges**

It is desirable that, public facilities such as elementary and junior high schools, district centers, meeting places, community centers, and gymnasiums planned in the future should function as disaster refuges, regardless of their size. In addition, users and administrative staff of the facility should have suitable emergency training on a routine basis. It is essential, and may be obligatory in the future, for newly built public facilities to have the functions needed to fulfill the role of a disaster refuge. There is a need for existing public facilities in districts to be structurally strengthened and given the functions to act as disaster refuges. It is also important to ensure that these facilities are recognized by residents as disaster refuges on a daily basis, by clear distinct markings with standardized signs indicating such administrative level facilities.

**Securing privacy**

In a disaster refuge with an area of large space providing shelter in the medium term, many evacuees of both sexes and all ages will be required to live under the same roof. It has been found the securing of privacy is important; although in the immediate aftermath of a disaster, evacuees sleep crowded together on the floor without any partitions, as they settle in, in many cases, they start to make low partitions with cardboard, etc. However, this does not secure any privacy, and affects changing clothes and sleeping, which imposes a lot of mental stress.

This issue was pointed out at the time of the Great Hanshin-Awaji Earthquake, and a variety of methods for ensuring privacy have been developed, including simple partitions. They were widely used in disaster refuges in the Great East Japan Earthquake. Such partitions should be easily assembled by the elderly and volunteers, and there are several types, including ones made with paper pipes and cloth, as well as thick cardboard and jointed parts. It is best to secure greater numbers of such materials than the estimated number of evacuated residents.

**Securing water and electricity**

Stockpiles of water should be determined by considering drinking and sanitation needs. Reservoirs for drinking water should be placed above the floor, and consideration to emergency shutoff valves and joints should be given. Electricity should be ensured by means of emergency power generating

equipment, etc. to meet the needs of refuge life, including lighting, water supply, drainage, communication, and air conditioning.

The estimated period requiring such water and electricity should be assumed to be longer than the period until the likely restoration of the public water supply and commercial electric power supply.

**Provision for utility problems**

In preparation for unforeseen accidents, alternative means of utility system equipment should be considered including power generating equipment (air-cooled type) and fuel, wells and regulating reservoirs for use in disaster situation, drinkable water filtration sterilization equipment, and emergency water-supplying ports.

**Provision of emergency stockpiles**

In addition, it is desirable to set up warehouses that store the needed amounts of ordinary emergency stockpiles. More than three days' worth of drinkable water, food, etc. for local residents is required.

**Information collection and transmission function**

Because a disaster refuge will also be used as a base for announcements by local government as well as for information collection and transmission concerning missing or dead people, and the rationing of food and water, etc., it is desirable to be equipped with systems or broadcasting equipment that can comprehensively transmit such essential information to the residents and evacuees. (Takashi Hirai and Takahiro Kishizaki)



Figure 1. The Ishinomaki Kadowaki Elementary School had been designated as a disaster refuge. Many people came by car and as the tsunami hit, vehicles smashed into each other and caught fire, which then spread to the school building. There is a need to review existing designated disaster refuges in tsunami areas.



Figure 2. A gymnasium that was used as a disaster refuge after the Great East Japan Earthquake. This simple partition system was designed by Shigeru Ban. The partition system played an important role for providing privacy in this disaster refuge. (Photo: Shigeru Ban Architects)

### 6-1 Planning earthquake resistant construction

The mechanisms for withstanding an earthquake vary depending on a combination of strength against bending forces and strength against axial forces. The fundamental tenet of earthquake-resistant design is to create a well-balanced structure by understanding the characteristics of these mechanisms and the selected structural materials.

#### Basic principle of withstanding an earthquake

To withstand an earthquake, as Figure 1a) shows, it is necessary to ensure mechanisms that can resist a force which pushes a structure in a horizontal direction. Clearly understanding and then selecting an appropriate mechanism is the essential core of planning and designing an earthquake resistant construction.

Looking at the figure again, if we view a pole standing on the ground as a structure, there are two methods to resist such horizontal force. One way is to resist a horizontal force by paying attention to the bending strength of the pole, assuming it is rigidly fixed to the ground as in Figure 1b). The other way is to resist the horizontal force by using diagonal braces as in Figure 1c).

As demonstrated on an ordinary structure with columns and beams, these two mechanisms are shown as the frames in Figure 1d) and 1e). One frame is based on the rigid jointing of columns and beams, which is effective because the beams rigidly fix columns to emulate the ground, and the frame can then resist a horizontal force. This kind of frame construction is known as a Rahmen. Another frame includes braces for columns and beams, and if they are covered in one plane, it becomes a wall.

The mechanism actually used to resist an earthquake is configured by combining the Rahmen-type and brace (shear wall)-type.

The basic principle of earthquake-resistant design is to plan a configuration by understanding the difference between these two mechanisms and verify the chosen design provides adequate safety.

#### Strength of the Rahmen-type

A Rahmen-type structure actually resists horizontal force by bending the deflection of beams and columns. Therefore, the structure's deformation as a whole is greater than the brace-type structure, and it is consequently a softer structure.

The strength of a Rahmen-type mechanism is based on the rigid jointing of columns and beams, where the strength of columns is controlled by the strength of beams. Obviously columns and beams continually support the weight of a building, but at the time of an earthquake, a great bending stress is added to their load, and therefore, sufficient consideration should be specially given to the safety of columns.

#### Strength of the brace (shear wall)-type

Let's look at the mechanism of the brace (shear wall)-type, next. Horizontal force propagates downward by compressing or pulling braces. In balance with these forces, compressive force or tensile force occurs in columns and beams. In other words, the frame resists horizontal force by the axial force exerted by the components that configure the frame, and because deformation of the components is small, deformation

of the brace-type mechanism as a whole is also small. This is a rigid mechanism that produces less deformation. The strength of the mechanism is determined by the compressive strength and tensile strength of the braces. However, when a force greater than their strength is applied, the mechanism buckles or fractures, and is likely to become unstable. Some allowance is necessary for strength.

A shear wall has the same mechanism; therefore, it is a rigid mechanism against a horizontal force. This means that when an opening is made in a shear wall, any brace not set to avoid the opening, will cause a problem.

#### Seismic planning

Seismic planning includes utilizing mechanisms for supporting the building weight, as well as adding an earthquake resistant element to the mechanism. Points to note for seismic planning are as follows (Figure 2).

1. When braces (shear walls) are used, they should be arranged with good horizontal balance and with vertical continuity.
2. Such arrangement should be imaged in three dimensions, i.e. observed from all angles.
3. When braces (shear walls) are used, many braces should be placed to increase the strength of the structure.
4. When a structure is planned with a Rahmen-type, dimensions and locations of columns should be well-balanced.
5. When a structure is planned with a Rahmen-type, the existence and dimensions of beam bearing columns need to be noted.
6. Both structures should have sections that prevent sudden fracture and collapse.

#### Steel structures and reinforced concrete structures

It is known the strength of any reinforced concrete structure has a limit against earthquakes. Therefore, tall and widespread buildings have had to adopt steel structures. Over the last two decades, however, high-strength concrete was developed and its strength when combined with high-strength bars has been verified, and moreover, precast and prestressed concrete have now been introduced. Today, it is now possible to build tall or widespread earthquake-resistant buildings using reinforced concrete structures, and both types of building offer an equally reasonable freedom of choice when considering all the factors involved in a project, including the characteristics and requirements of the building, workability, construction costs, and construction period.

#### Issues of detail

To prevent the sudden fracture and collapse of a steel structure, it is important to prevent buckling and fracturing of joints.

In the case of reinforced concrete structures, preventing concrete cracking, reinforcing by rebar, the arrangement of earthquake-resisting slits, etc. are important.

It is also important to utilize these measures when expressing the architectural form of the building and planning the arrangement of the equipment.

#### Development toward composite structures and mixed structures

Rational structures made by combining concrete and steel have been developed. As composite structures, composite

floor, composite beam, CFT (concrete filled steel tube), etc. have become popular (Figures 3, 4, 5 and 6). Applying such concepts to the whole building, it is also rational to make the building periphery using a steel structure and the building core with a reinforced concrete structure; this is commonly known as a

mixed structure. Though these methods require the thorough study of details, it will be possible to create new structures by extending the materials used to include more than the ubiquitous concrete and steel.

(Yoshikazu Fukasawa)

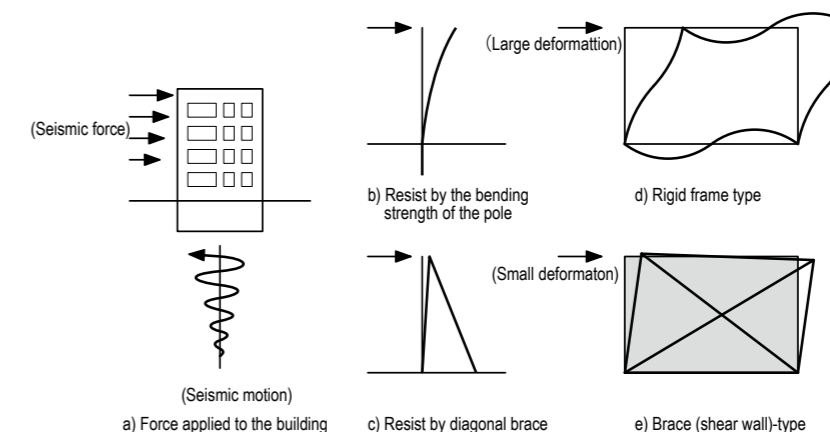

Figure 1. Flow of force

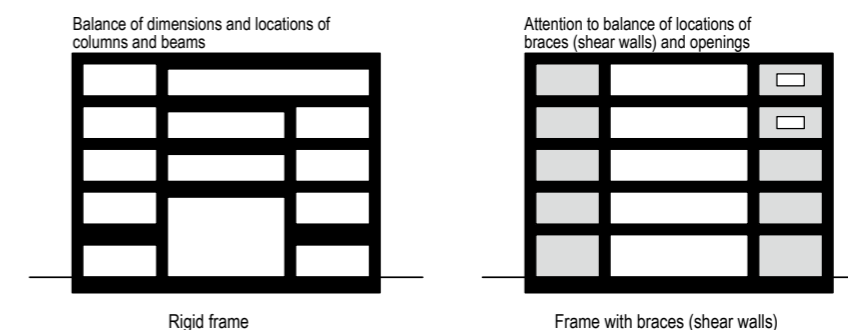

Figure 2. Balance of frame

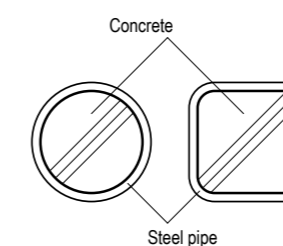

Figure 3. Section of CFT column

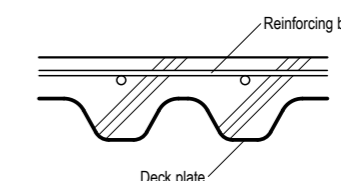

Figure 4. Composite floor

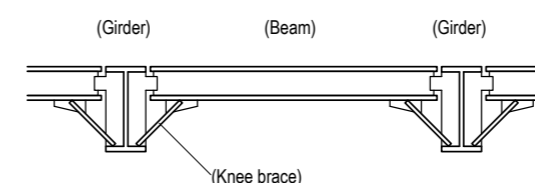

Figure 5. Prevention of buckling of girders

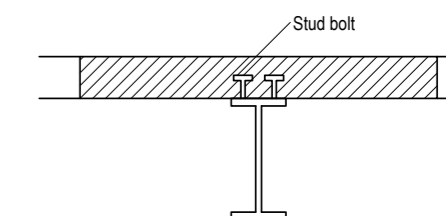

Figure 6. Composite beam

## 6-2 Planning seismically isolated structures

A seismically isolated structure reduces seismic force applied to a building by seismic isolators and absorbs seismic energy by damping devices. A seismic isolated structure can reduce damage to not only a building's structure but also its finishing materials, etc.

### What is a seismically isolated structure?

The perfect seismically isolated structure has a mechanism which reduces the effect of seismic motion propagated from the ground to the structure to zero. The idea is to realize a mechanism that allows a building to slide with no friction, while still supporting the building's weight. However, the building will move in sufficiently high winds, and it is difficult to predict where the building will have been moved to by the earthquake. As a mechanism that can realistically solve this problem, laminated rubber bearings were developed.

As Figure 1 shows, a laminated rubber bearing is a laminated body of steel plates and thin rubber plates, and the rubber plates restrained by the steel plates support the building's weight. Horizontal force propagates with the shear deformation of the rubber plates, which are large as a whole, as well as relatively soft. Therefore, any superstructure including laminated rubber plates has a long natural period. Seismic motion does not propagate well into a building whose natural period is much longer. This is the basic principle of a seismically isolated structure.

Another factor that makes seismically isolated structures possible is damping devices, which can be effectively placed where large horizontal displacement occurs due to seismic isolators. These damping devices can dampen the building's motion, which relative to the ground is great.

### Seismic isolators

Presently, laminated rubber bearings, laminated steel plates and thin rubber plates, and sliding bearings as seen in Figure 2, are the main types of commercially available seismic isolators. Sliding bearings are a device that hold the building on the spot, until a certain level of seismic motion with frictional force is reached, and when the limit is exceeded, the device starts to slide. Therefore, a mechanism to move the building back to its original position is required.

### Damping device

As damping devices, high damping rubber bearings whose laminated rubber has a damping effect, lead rubber bearings which have a lead plug inserted in the center of the laminated rubber as seen in Figure 3, sliding bearings for which a coefficient of friction has been adjusted, etc. are used, and embedded into a seismic isolator.

In addition, as damping devices which independently give a damping effect, hydraulic and steel dampers as shown in Figure 4 and Figure 5 respectively, lead dampers, etc. are used. These devices utilize the plastic deformation of the lead or steel element, or viscosity which resists according to the velocity, or frictional resistance.

### Layout of seismic isolators and damping devices

The horizontal layout of seismic isolators and damping devices require a well-balanced arrangement so that torsion

due to seismic motion will not occur in the superstructure.

In terms of their vertical arrangement, base isolation which sets seismic isolators and damping devices under the foundations, and mid-story isolation which places seismic isolators and damping devices between the structures (Figure 6) are mainly used.

### Usefulness of seismically isolated structures

A seismically isolated structure, which makes the natural period of the superstructure longer and decreases the acceleration, will reduce the damage to finishes and equipment.

Buildings with a seismic isolated structure not only ensure safety against giant earthquakes, but also suffer little damage from relatively great earthquakes that cause damage to ordinary buildings. In that sense, a seismic isolated structure is ideal for those buildings for which the maintaining of functions at the time of an earthquake is required.

In addition, because seismic isolators can reduce the seismic force input to a superstructure, they are an effective countermeasure for those buildings which cannot be seismically strengthened by such measures as adding shear walls; for some buildings this can be achieved by digging under the foundations to position seismic isolators. The method is known as a "retrofit" (Figure 7).

### Cost of seismically isolated structures

When a seismic isolated structure is adopted, because the seismic force that propagates to the superstructure is reduced, the cost of the skeleton work may be reduced slightly. However, total construction costs will be increased by about 10% because of the cost of seismic isolators, etc. and the construction costs of the base-isolated layers need to be added as well. Despite such increased costs, when a high level of performance is targeted, it is possible that only a seismic isolated structure may achieve the specifications. Should a great earthquake occur, a seismic isolated structure will suffer little damage, and eventually have a lower life cycle cost. When all the various factors are considered, the cost-effectiveness of seismic isolated structures is still attractive.

### Points to note for seismically isolated structures

#### 1. Ensuring adequate clearance

Because seismic isolators greatly deform in the horizontal direction at the time of an earthquake, the distance between the building and the ground will be subject to considerable change. Therefore, sufficient clearance should be ensured to avoid collisions (Figure 8).

#### 2. Expansion joints

Floors, walls, ceilings, and equipment that straddle clearance should have a mechanism to adequately follow the horizontal displacement of the building.

#### 3. Design against wind

When a sufficiently strong wind hits a seismic isolated building, the building may move depending on the strength of the seismic isolators. In the case of lightweight buildings and high-rise buildings, it is important to achieve a good balance between design against earthquakes and design against wind.

#### 4. Importance of inspection

Seismic isolators, damping devices, and base-isolated layers must be maintained so that they will function at the time

of an earthquake. Therefore, adequate spaces should be ensured for periodic inspections and for checks and repairs after an earthquake. In addition, a system to ensure methodical and regular inspections should be established.

(Yoshikazu Fukasawa)

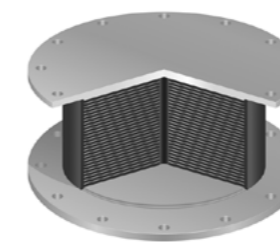

Figure 1. Laminated rubber bearing

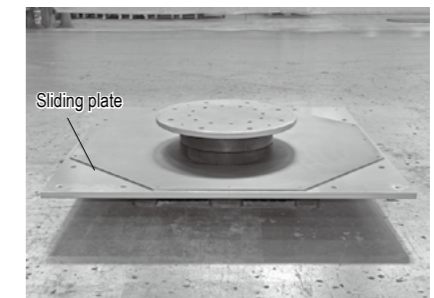

Figure 2. Sliding bearing

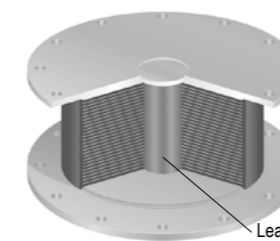

Figure 3. Lead rubber bearing



Figure 4. Hydraulic damper for base isolation

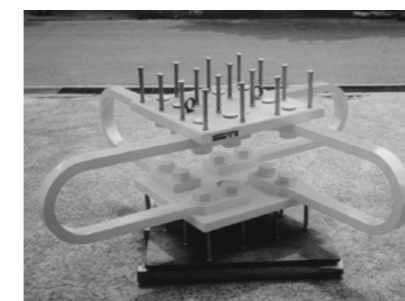

Figure 5. Steel damper

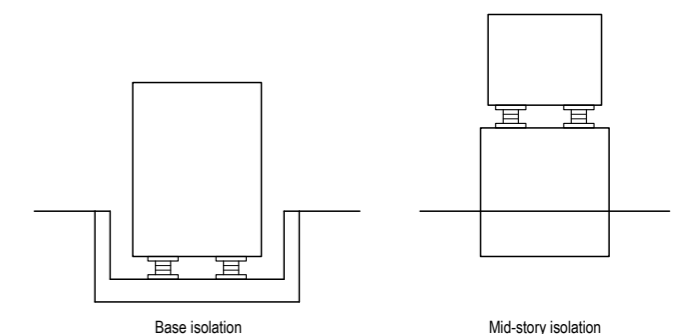

Figure 6. Base isolation and mid-story isolation

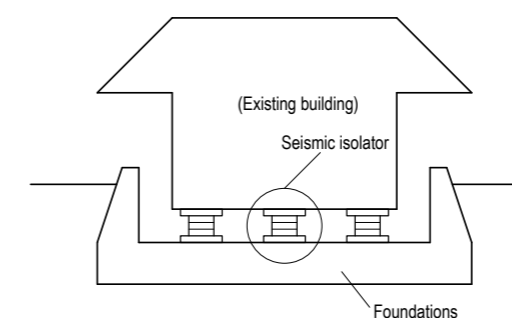

Figure 7. Base isolation retrofit

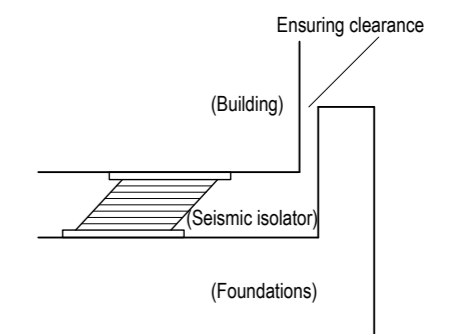

Figure 8. An example of the arrangement of dampers (Shinjuku Center Building, Drawing: Taisei Corporation)

### 6-3 Aiming for response controlled structures

A response controlled structure reduces the vibration of buildings by absorbing the vibration energy that arises in a building. By taking the measure of disturbances including vibration due to small and great earthquakes, and high winds, an effective mechanism should be designed.

#### What is a response controlled structure?

A response controlled structure reduces the vibration of buildings by installing equipment or mechanisms to dampen vibration.

Looking at the response control effect in terms of energy, it is a structure that absorbs seismic energy, which is input from the ground, by means of the equipment of a mechanism. It is also understandable in the terms of the conversion of kinetic energy to thermal energy.

Therefore, the key point of the design is how to effectively absorb the vibration energy. In other words, the technique involves placing equipment or mechanisms with a great absorbing capacity at positions with easy-absorbance characteristics.

To secure the effectiveness of this structure, it is necessary to estimate a building's vibration at the time of an earthquake, and design the building, while validating the effectiveness of the layout of the equipment.

#### Types of damper

##### 1. Metal dampers

Steel, lead, etc. are selected as materials that are capable of offering great plastic deformation, and can be manufactured into shapes offering easy plastic deformation. They include steel and lead dampers.

##### 2. Viscous dampers

Viscous materials such as oil or viscoelastic material are used; the method includes hydraulic dampers and viscous walls (Figure 1, 2, 3 and 4).

##### 3. Friction dampers

Frictional force is used as a controlling force; also included are break dampers.

##### 4. Mass dampers

Mass dampers absorb vibration by installing a vibration system of the same natural period as the building. It follows the same principle as dynamic vibration absorbers used for mechanical systems.

#### Layout of dampers

Dampers should be placed where vibration will be great; they must also have a well-balanced configuration.

At the time of an earthquake, a building experiences the greatest vibration at the uppermost floor, but, there is nothing to give reactive force back to any damper located there. Therefore, a mass damper (Figures 5 and 6) which creates its own reactive force may be used, although there are constraints concerning equipment weight, range of motion, etc.

As is the case with seismically isolated structures, it is effective if dampers can be placed at the base-isolated layer where horizontal displacement is great. In that sense, it can be said that a seismically isolated structure is also one of the response controlled structures.

It is also effective to make structures with different vibration characteristics and connect them by dampers to offset

vibrations (Figure 7).

In the case of high-rise buildings, it is popular to place dampers by stories in response to the different displacements of stories (Figure 8).

#### Usefulness of response controlled structures

A response controlled structure that is effective against small vibrations, including viscous dampers and mass dampers, is effective against relatively great earthquakes that are subject to primary design in ordinary earthquake-resistant design. When they are arranged well, vibration of the building can be reduced to about a half compared with buildings without dampers. In addition, vibration of the high-rise building after the earthquake is also reduced.

Against great earthquakes of secondary design level, metal dampers are effective. Viscous dampers, mass dampers, etc. that are effective against small vibrations should be checked whether they exceed the range of motion or not. When they are effectively designed, no damage of the structural frame will occur except that borne by the dampers.

#### Active response control

Active response controls are being developed that provide optimum response control, by adopting dampers with variable characteristics according to the state of vibrations. The system realizes optimum control by processing the data measured by vibration sensors set in various locations throughout a building. However, even active response control systems have their limitations, including the requirement of a constant energy source to maintain the system functions.

#### Countermeasures against vibration and wind

Earthquakes are not the sole cause of building vibration. Especially, vibration caused by strong winds sometimes becomes an issue for high-rise buildings. Response controlled structures for controlling vibration caused by wind are required to work for many hours. Unfortunately, response controlled structures as countermeasures against an earthquake are sometimes unsuited to prolonged vibrations for many hours. There is a need to devise mechanisms that stop operation of the vibration control system as necessary, by adequately considering countermeasures against both an earthquake and high winds.

(Yoshikazu Fukasawa)

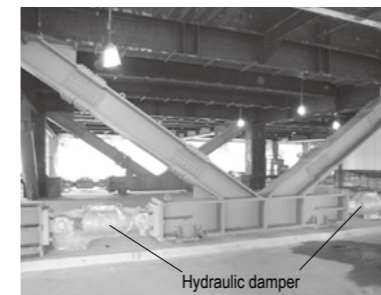

Figure 1. Hydraulic damper



Figure 2. Viscous damper

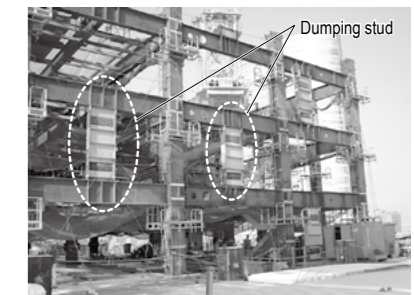

Figure 3. Vibration control stud



Figure 4. Viscous wall

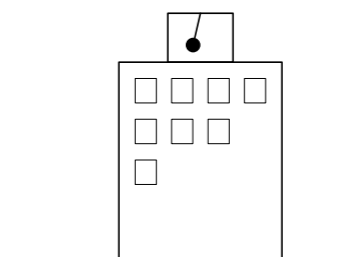

Figure 5. Placement of mass damper

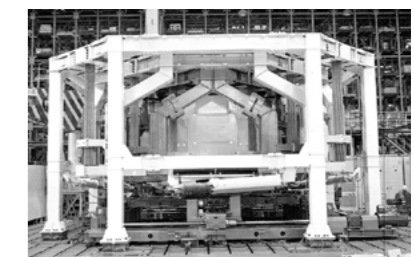

Figure 6. Mass damper (multistage pendulum)

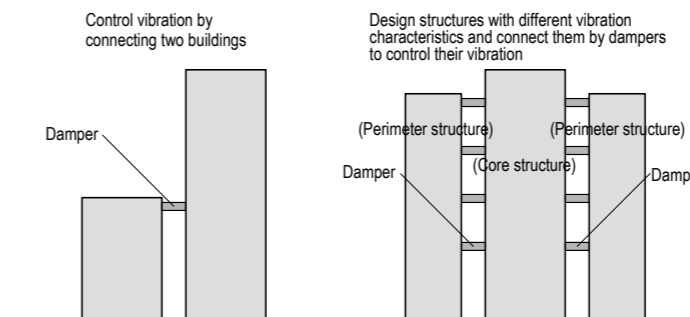

Figure 7. Coupled vibration control

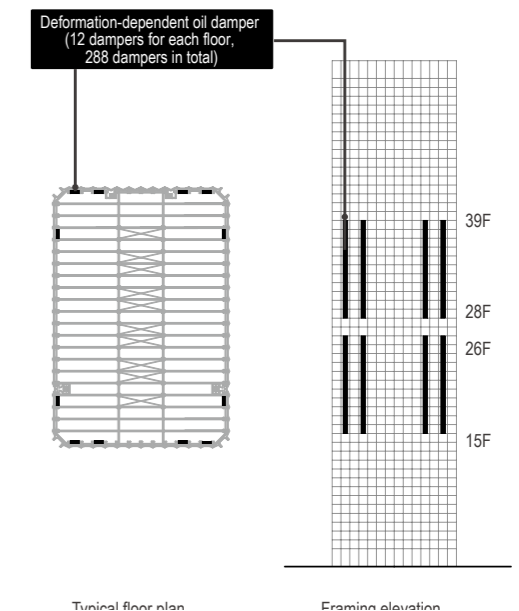

Figure 8. An example of the arrangement of dampers (Shinjuku Center Building, Drawing: Taisei Corporation)

### 6-4 Aseismic planning of high-rise buildings

A high-rise building at the time of an earthquake will be subject to a great amount of slow swaying; the aseismic planning of high-rise buildings aims to control such movement, minimize the shaking and ensure the safety of the building during an earthquake.

#### Quaking of high-rise buildings

The higher the building, the more slowly it quakes horizontally with a longer natural period (Figure 1). In general, the natural period of a building is about one second for a height of 30 m, one and a half seconds for 60 m and three seconds for 100 m.

A building with a long natural period quakes greatly and slowly at the time of an earthquake (Figure 2). However, the ratio of seismic force applied to a high-rise building to the building's weight is smaller than that for a low-rise building (Figure 3). This is an important point for the aseismic planning of high-rise buildings aimed at the control of quakes; it is important to thoroughly analyze how the planned building quakes, so as to ensure a safe building, and more comfort and less danger for the residents.

#### Controlling quakes

There is a school of thought that considers the natural period of a high-rise building should be made long by adopting a seismically isolated structure or a response controlled structure. However, it is common to plan the building so as to shorten its natural period, which may with a particularly high building be quite long.

It is also important to plan the building so that any local increase of shaking by twisting of the building is prevented.

#### Reduction in weight

The heavier the building, and the lower the horizontal rigidity, the longer the natural period of the building; therefore, to make the natural period shorter, it is necessary to make the building lighter and the horizontal rigidity higher.

Reduction in weight starts by making floor structures lighter, but without sacrificing the building's habitability.

#### Increasing horizontal rigidity

It is easy to understand that higher buildings are more prone to deform; especially, the greater the ratio of building height to width. Basically, the slimmer the building, the greater probability of deformation; this particularly applies to buildings with wellhole-style spaces or large-scale spaces, which are even more likely to deform.

To increase horizontal rigidity, the following basic principal, as mentioned in Section 6-1, should be applied.

When a structure is planned with a Rahmen-type, the building as a whole resists by arranging the rigidity of columns and beams.

When a structure is planned with a brace-type, braces (shear walls) are placed all over the building, or a large frame is configured whose plane of structure, where braces are placed, can be regarded as large columns and beams (Figures 4, 5 and 6).

#### Controlling torsional vibration

When a high-rise building twists, horizontal displacement

increases further, and the higher the floor the greater the displacement.

To control torsional vibration, torsional rigidity should be increased, and horizontal rigidity and mass eccentricity should be decreased.

To increase torsional rigidity, peripheral rigidity should be increased.

To decrease eccentricity, the plan should be close to symmetrical.

#### Relationship between upper part and lower part

There are many building projects that combine an upper part and lower part. In such cases, torsion may occur in the building. The torsion should be controlled by arranging the horizontal rigidity, or the upper and lower parts should be structurally separated by placing expansion joints in between them (Figure 7).

#### Increasing damping performance

To reduce great and slow quakes, dampers that absorb vibration should be set in the building. That is, the response controlled structure described in Section 6-3 should be adopted.

Vibration may be reduced almost by half by increasing damping performance. It is also effective for long period seismic motion which has been an issue of high-rise buildings, and can reduce vibration of the building after an earthquake.

#### Avoiding the deformation of finishing materials

There should be some device to ensure finishing materials do not suffer damage when great horizontal deformation occurs.

Curtain walls should be adopted for exterior walls to absorb relative story displacement (Figure 8). Interior walls, vertical piping for equipment, elevators, etc. should also be made to absorb the relative story displacement. Ceiling, lighting fixtures, etc. shake hard when their natural period matches that of the building, and require countermeasures. Countermeasures should be taken for furniture on upper floors not to move or overturn.

#### Consideration on construction efficiency and economic efficiency

In the process of aseismic planning as mentioned above, the construction efficiency and economic efficiency of high-rise buildings should also be considered in parallel. In such cases, composite structures or mixed structures, discussed in Section 6-1, may be effective.

(Yoshikazu Fukasawa)

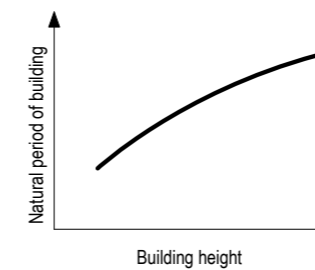

Figure 1. Building height and natural period



Figure 2. Building height and horizontal displacement

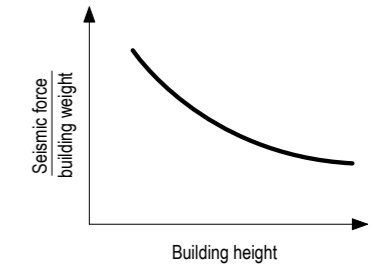

Figure 3. Building height and seismic force/building weight

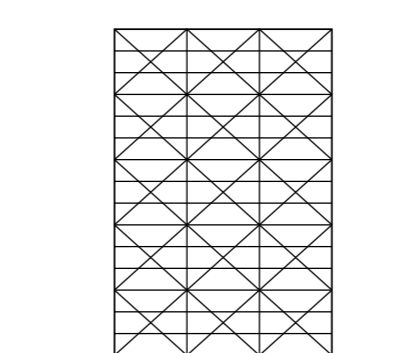

Figure 4. Structure with braces all over the frame

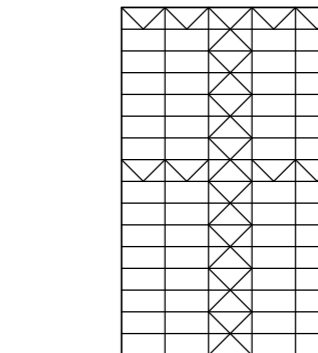

Figure 5. Large frame 1

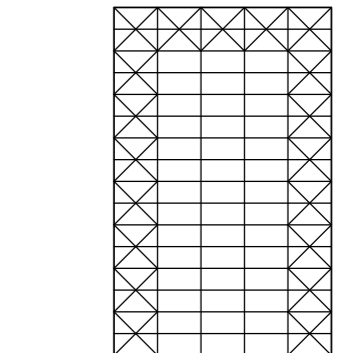

Figure 6. Large frame 2

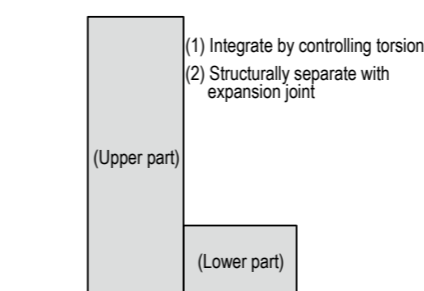

Figure 7. Lower part and upper part

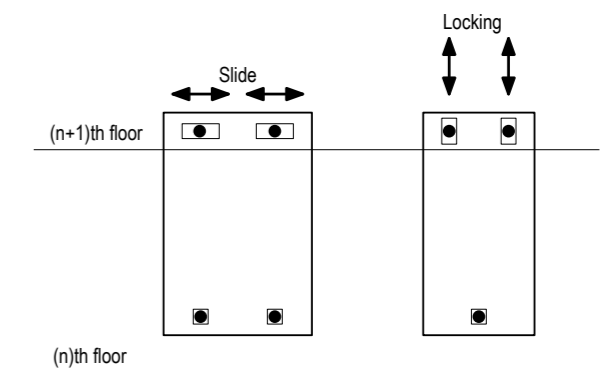

Figure 8. Mechanism of curtain wall

## 7-1 Well-balanced buildings and earthquake resistant performance

It should be noted that not only obviously irregular-shaped buildings, but also apparently regular-shaped buildings can be unbalanced in terms of earthquake resistant performance. However, an unbalanced building can be made well-balanced by incorporating structural frames and changing the building construction, although such work may increase the cost.

### Basic idea of securing earthquake resistant performance

The basic idea is to make the building shape as regular as possible and to ensure its structural frame as a whole is well-balanced. As seen by recently damaged examples an un-balanced building in terms of plan or elevation is prone to suffer earthquake damage.

### Planar balance (modulus of eccentricity)

The eccentricity of a building is the difference between the center of gravity and the center of rigidity (center of its earthquake resisting elements including columns, beams, shear walls and braces). When the eccentricity becomes great, a torsional deformation around the center of rigidity caused by seismic force arises.

Buildings with a point-symmetric planar shape such as the rectangle, cross, and Z-shaped buildings seen in Figure 1 are well-balanced buildings that do not produce torsion due to eccentricity because the center of gravity and the center of rigidity coincide.

In contrast, buildings with a line-symmetric planar shape such as T, L, U, and arc-shaped buildings are unbalanced buildings that produce great torsion due to eccentricity between the center of gravity and the center of rigidity in asymmetric directions.

### Seemingly regularly-shaped buildings can be unbalanced

A building with a point-symmetric planar shape can be an unbalanced building when shear walls (braced) are eccentrically located or column spans are not uniform.

As Figure 2 shows, a cross-shaped building produces smaller horizontal displacement in the longitudinal direction against the seismic force's direction  $\delta_1$ , while producing greater horizontal displacement of the projecting part  $\delta_2$ . A difference in the displacements occurs, a great horizontal force propagates at the joint part, and great stress is applied to the internal corners, marked by circles (○) in the figure. In most

cases, this stress does not show up in the present consistent structural calculation program, that analyzes structures based on a rigid floor assumption, i.e. a floor slab does not produce in-plane distortion. Therefore, many structural designers are prone to overlook this point. Z, T, L, and U-shaped buildings experience similar problems to the above.

### Elevational balance (story stiffness ratio)

When the hardness (horizontal stiffness) of a structural frame varies widely depending on the stories in a multi-story building, horizontal displacement and damage of building elements will concentrate on the story with the lowest horizontal

stiffness. It should be considered as an unbalanced building; typical examples are a building with pilotis (Figure 3) as well as a building that includes a greater story height (Figure 4).

### Other unbalanced buildings

A setback building produces little torsion when seismic force is applied to every story in the same direction. This state can be achieved by adjusting sections of columns and beams based on a static analysis so that the center of gravity and the center of rigidity coincide. However, actual seismic motion does not necessarily act on all stories in the same direction. Depending on the stories the direction varies and great torsion can be produced. As this kind of shape is prone to twisting, attention should be paid to this factor (Figure 5).

A twin building requires caution because it is prone to produce stress concentration at the foot of a high-rise part. Furthermore, if the building heights of two parts are different, they quake independently at the time of an earthquake, and may deform in the reverse direction. Therefore, it is necessary to study not only stress concentration at the foot of the high-rise part but also torsional moment produced in the low-rise part by inertia force from the high-rise part (Figure 6).

### Improvement by devising a structural frame and building construction

Ways to improve unbalanced buildings are as follows:

1. To minimize torsion by making the center of gravity and the center of rigidity coincide as much as possible by means of adjusting sections of column, beam, and shear wall, as well as changing the layout of shear walls (braces).
2. To strengthen any part where stress concentrates.
3. To increase the earthquake-resistant strength to a level higher than that of a well-balanced building.
4. To separate a building by using expansion joints (EXP. J) and make each part a well-balanced shape (Figure 7).

The technique in number 4 is commonly used; also an effective and recently increasingly popular method is the adoption of a seismically isolated structure.

### Designer awareness

This section has discussed some examples of unbalanced building in terms of their earthquake resistant performance. There are other types of unbalanced buildings including buildings on sloping ground with different foundation levels, buildings with partial basements, and large-scale space structures that require a variety of suppositions to calculate their force flows. Structural designers should plan and design buildings based on objective assessments. In addition, they should keep in mind that an unbalanced building will go onto cost more than a well-balanced building.

(Takashi Yonemoto)

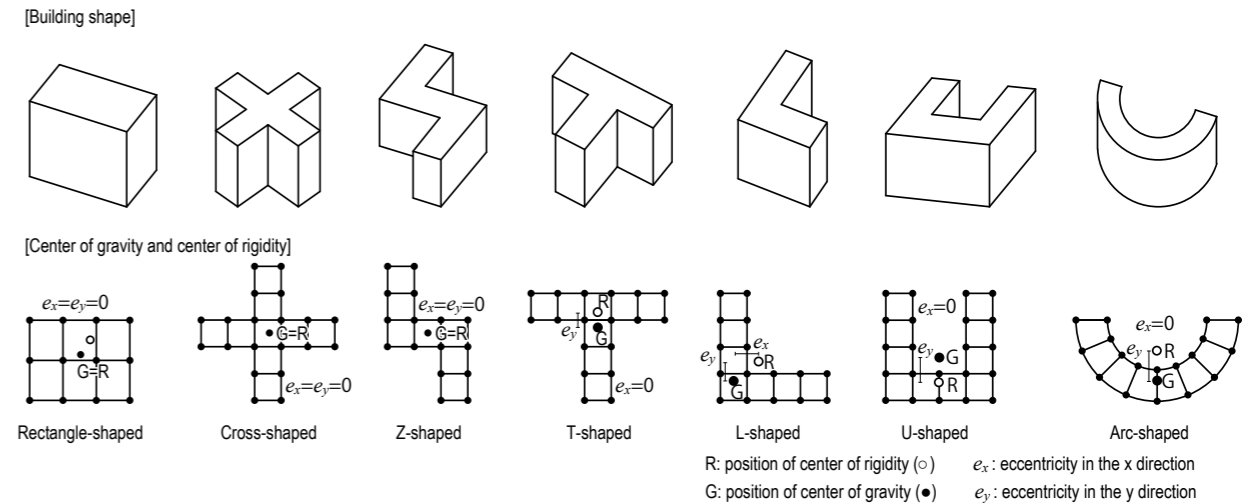

Figure 1. Center of gravity and center of rigidity of planer shape

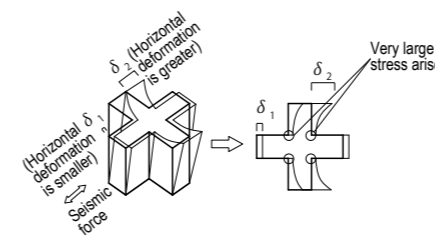

Figure 2. Deformation and stress concentration of a cross-shaped building at the time of an earthquake

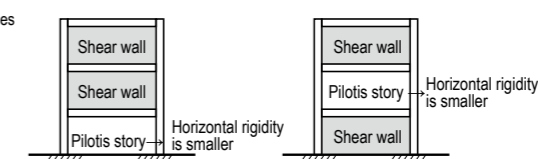

Figure 3. A building with pilotis

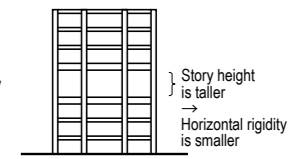

Figure 4. A building with one story higher than the others

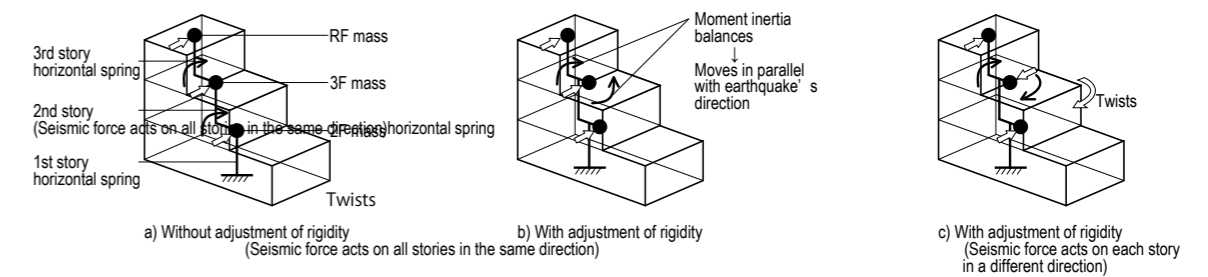

Figure 5. Analysis models and behaviors of a setback building at the time of an earthquake

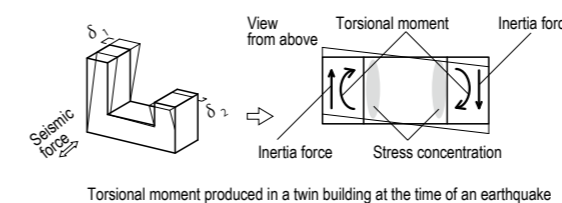

Figure 6. Behavior of twin building at the time of an earthquake

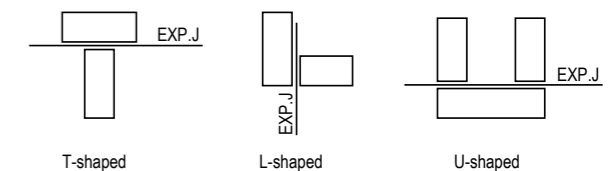

Figure 7. Expansion joint



## 7-2 Buildings with good planar balance

**Eccentricity means the difference between the center of gravity and the center of rigidity. When the eccentricity of a building is great, seismic force makes the building twist, and may cause local failures.**

### Structural balance of a building

Seismic force is an inertia force that acts on the stories of a building as a horizontal force, and is equal to the mass of a selected story plus the upper stories multiplied by the response acceleration. A structural element that resists this seismic force is called an earthquake resisting element. When shear walls and columns which are effective as earthquake resisting elements are unbalanced in the stories of a building, the building as a whole may suffer unexpectedly great damage at the time of an earthquake.

Whether the planar balance of rigidity is good or bad depends on the distance between the center of gravity, which is the center of the building's weight, and the center of rigidity, which is the center of the earthquake resisting elements including columns, beams, and shear walls. This difference of the centers is called eccentricity, and the distance between the center of gravity and the center of rigidity is known as the eccentric distance. Any eccentricity is caused by eccentrically-located shear walls, non-uniform spans, eccentrically-located stories, etc. (Figure 1).

### Torsional behavior of a building

When the location of the center of gravity and the center of rigidity are different, seismic force rotates the building around the center of rigidity, and produces a rotational displacement around this center, which is known as torsion (Figure 2).

In normal buildings, it can be assumed that horizontal seismic force does not cause in-plate distortion of a floor slab because the in-plate rigidity of a floor slab is very high (this is called the rigid floor assumption). Regarding the buildings to which rigid floor assumption is applicable, the better a building is balanced the more similar displacements of every part of the story occur. Such parallel displacement is called translation (Figure 3).

When positions of the center of gravity and the center of rigidity are different, rotational movement of the building occurs in addition to translation, and displacement differences are produced. The greater the eccentric distance, the greater the displacement difference becomes, and the greater the distance from the center of rigidity, the greater the displacement difference becomes (Figure 4). As the result, a twisted rotational behavior is produced when seismic force acts on the building, the parts that are distant from the center of rigidity locally collapse, and the building suffers great damage (Figure 5).

### Modulus of eccentricity

The modulus of eccentricity is defined as a ratio of the distance between the center of gravity and the center of rigidity (eccentric distance) to the torsional resistance (spring radius), and the smaller its value the better the building is balanced.

$$\text{Modulus of eccentricity } R_e = e/r_e$$

Here,  $e$  = eccentric distance,  $r_e$  = spring radius

Buildings that have a bad balance of rigidity are prone to locally collapse before they adequately deliver earthquake resistant performance of the whole structure. Therefore, the current Building Standard Law of Japan and Enforcement Order require the planning layout of the earthquake resisting elements to give a modulus of eccentricity for each story of 0.15 or less. They also require a building whose modulus of eccentricity is greater than 0.15 to boost the horizontal load-carrying capacity of an ordinary building by 1.0 to 1.5 times. The degree of increase depends on the modulus of eccentricity value. This may increase the building cost.

This prescription intends to bring greater strength to a building which is prone to twist. These values have been determined by considering the general tendencies found in the analytical studies of building damage due to earthquakes, and the ideas and the values are tentative proposals.

### Advantages of a seismically isolated structure and a seismic-response controlled structure

A base isolated building produce no local collapse due to torsion even at the time of a great earthquake because it keeps its elasticity. In other words, even when the part of a building above the base isolated layer has a high modulus of eccentricity, it is possible to make a building which is little-affected by torsion, by matching the center of gravity and the center of rigidity of the base isolated layer (Figure 6).

Though a seismic-response controlled structure is less effective, a considerable effect to absorb seismic energy and to control torsion can be expected by placing damping members on the planes of structure where deformation due to torsion is anticipated. It is important to layout damping members in a well-balanced way, and as much as possible install them on the periphery in order to gain the controlling effect of torsion (Figure 7).

### Problems of the current standards

Although the methods used to deal with eccentricity in the current Building Standard Law of Japan are effective, uniformly increasing the building strength as a whole, when the modulus of eccentricity is high, is sometimes very inefficient and may constrain building plans. In such cases, it is more effective to plan a building whose torsion is controlled by isolating or absorbing seismic energy by means of a seismically isolated structure or seismic-response controlled structure. However, their effects are hard to evaluate by the current analytical method (static analysis), but are confirmable by time history response analysis. (Masatoshi Iida)

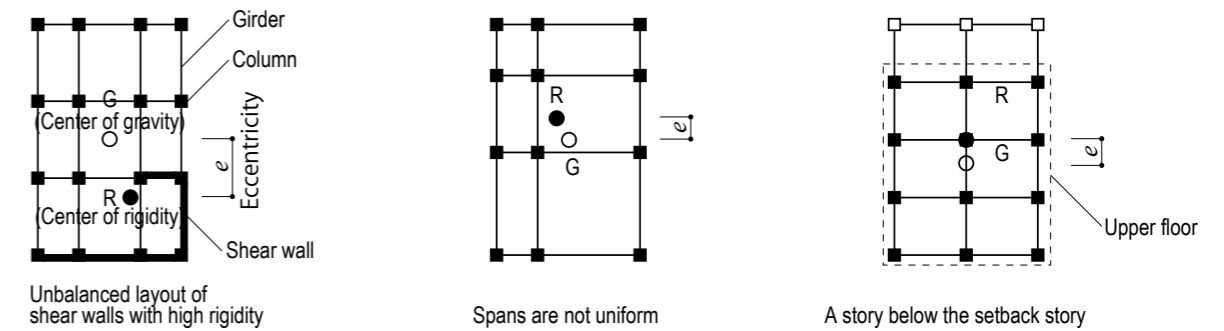

Figure 1. Examples of unbalanced planar rigidity

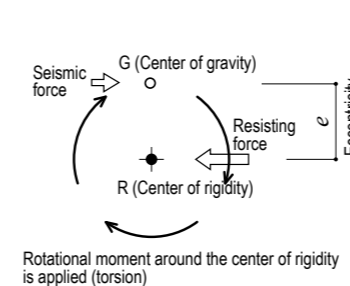

Figure 2. Rotational movement due to difference in position between the center of rigidity and the center of gravity

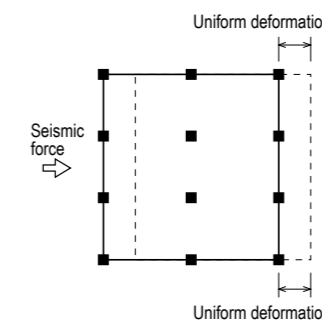

Figure 3. Well-balanced building (translation)

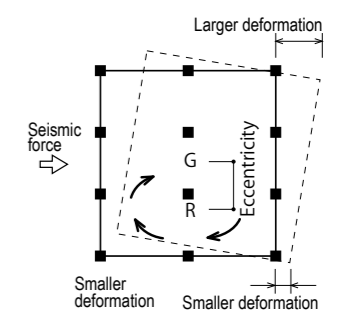

Figure 4. Unbalanced building (torsion)

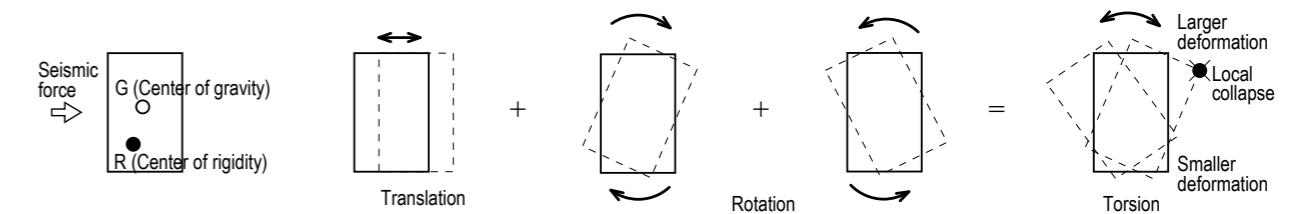

Figure 5. Local collapse due to torsional behavior

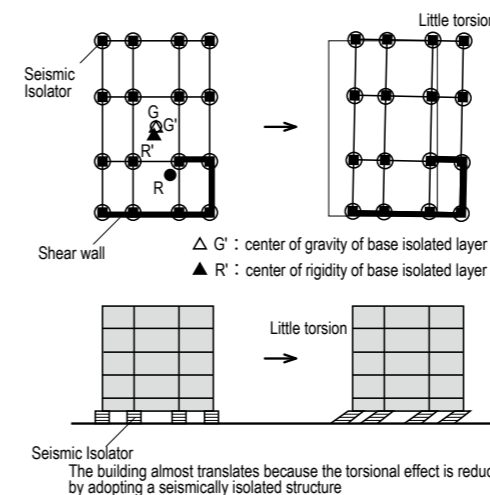

Figure 6. Advantage of adopting a seismically isolated structure

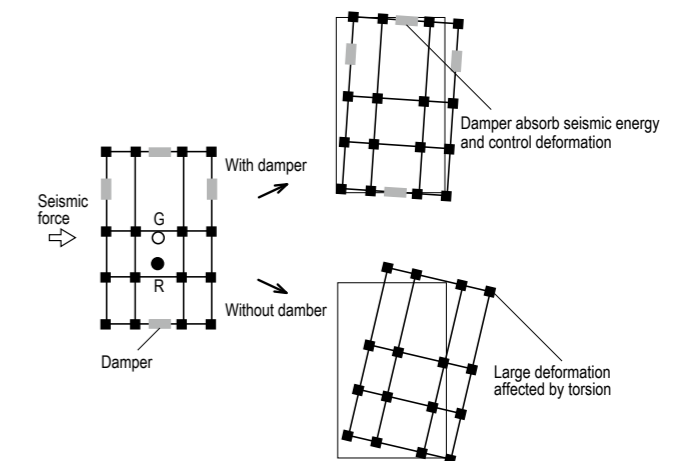

Figure 7. Advantage of adopting a seismic-response controlled structure

### 7-3 A story with low rigidity in any part of a building should be avoided

The balance of rigidity between stories, restrictions on story deformation angles, and so on are key factors for the safety and strength of buildings. As an index, restrictions on the story stiffness ratio have been established.

#### Damage caused by the story stiffness ratio

Regarding the damage noted in field studies and reports of recent earthquakes, damage seemingly caused by the story stiffness ratio are described below.

Damage including the story collapse of a pilotis part of the ground story and shear failure of pilotis columns were observed in buildings as shown in Figure 1.

Collapse of an intermediate story seemingly due to the great difference in rigidity and strength from other stories with the other structure type was observed in the middle-rise building shown in Figure 2.

#### What are the story stiffness ratio and story deformation angle?

When owing to shear walls, spandrel walls, etc., the upper stories have greater rigidity and strength, than a lower story, as shown in Figure 3, a lower story suffers great damage even when the upper stories suffer minimal damage, because seismic energy centers on the lower story.

An appropriate countermeasure, in terms of earthquake resistant construction, is to plan a good balance of rigidity between stories, so that the building as a whole can absorb seismic energy. Specifically, one method is to increase the rigidity and strength of the building as a whole by placing earthquake resisting elements including shear walls and braces on stories in a well-balanced way; another approach is to adopt a pure Rahmen structure that consists of only columns and beams, and ensure the rigidity and strength of each stories by adjusting the sections of columns and beams (Figure 4). The former method requires placing earthquake resisting elements efficiently. It is often difficult to be consistent with architectural and equipment planning, and so it should be considered in the early stage of design.

On the other hand, a pure Rahmen structure is a frame which resists seismic force by using columns and beams as earthquake resisting elements. Though it is relatively easy to design a plan because there are no braces or shear walls, attention should be paid to determining ceiling heights, etc. because sections of columns and beams tend to become larger. Especially in the case of a building that includes long spans, or has great ceiling height, or that is heavy, etc., the planning of the building takes ingenuity such as designing using sections with allowances, or to install stud-shaped earthquake resisting elements as Figure 5 shows.

While a pure Rahmen structure has rigidity of stories in a well-balanced way and can absorb seismic energy as a whole building, when the rigidity of stories are low, relative story displacements increase, and the degree of damage also tends to increase. To reduce the damage at the time of an earthquake, it is important to minimize relative story displacements.

As quantitative indexes of the earthquake resistance of buildings mentioned above, the story stiffness ratio indicates the balance of rigidity between stories, and the story deformation angle (value of relative story displacement divided by story

height) indicates the degree of a building's damage.

#### Buildings to which attention should be paid

Stories such as a ground story which includes an entrance and an intermediate story which includes a hall, as shown in Figure 6, often require relatively large spaces, and such specific stories are prone to suffer intensive damage.

For planning a building with offices and shops on the lower stories and residential units on the upper stories, as Figure 7 shows, a layer in between the upper and lower is required for placing a switching equipment system. In such cases attention should be paid to the structural balance, which varies depending on whether it is treated as a story by placing beams right above and below, or as a large girder by making it a pit form with dual floors.

In the case of a building with different structure types between lower and upper stories, such as a steel encased reinforced concrete structure for lower stories and a reinforced concrete structure for upper stories as Figure 8 shows, attention should be paid because the rigidity and strength of the structure may vary greatly and a story collapse as seen in Figure 2 may occur.

In the case of planning a building with a one- or two-storied steel structure penthouse as seen in Figure 9, attention should be paid because the steel frame behaves like a whip and produces very strong acceleration.

#### On seismically isolated structures

When a building includes a story with low rigidity, seismic energy concentrates at that point. Taking advantage of such a characteristic, a structural design that intentionally places a story with low rigidity at the lowest level of the building to absorb seismic energy at that point and thus reduce the damage to upper stories is effective. A typical example is a seismically isolated structure. By adopting a seismically isolated structure, whose base-isolated layer has a much lower rigidity than other stories, even a pilotis-type building like Figure 1 can reduce the possibility of story collapse. (Hirofumi Yoshikawa)

□Source of figures

1) Edition by the Special Committee on Urban Disaster, the Japan Institute of Architects, "Earthquake-resistant Building Design for Architects," Shokokusha, 1997



Figure 1. An example of the story collapse of the pilotis part of the ground story



Figure 2. An example of the story collapse of an intermediate story<sup>1)</sup>

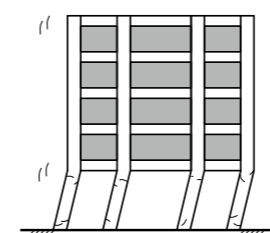

Figure 3. Story collapse of a pilotis-style building

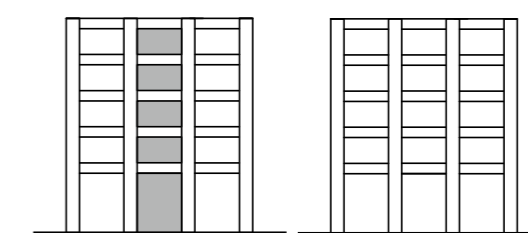

Figure 4. Examples of frame style

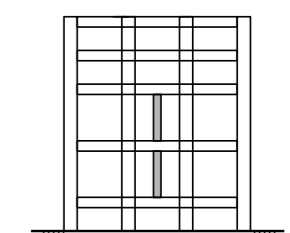

Figure 5. Installation of studs

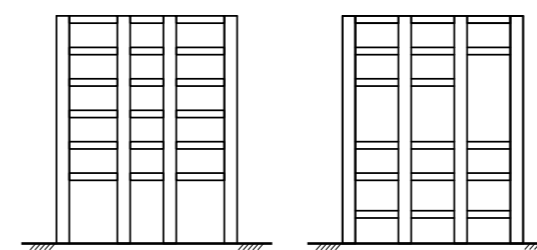

Figure 6. Buildings to which attention should be paid

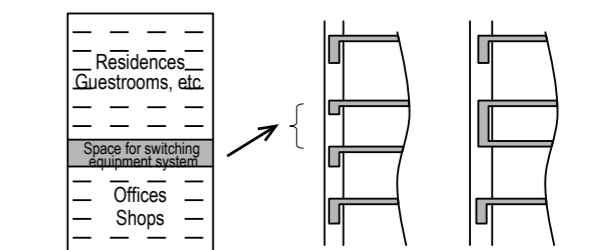

Figure 7. An example of switching building use

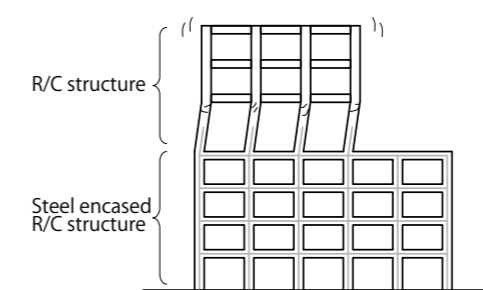

Figure 8. An example of jointing in a building with different structure types

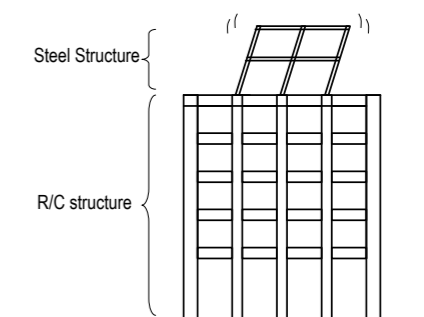

Figure 9. An example of damage to a penthouse structure type

## 7-4 Benefits of expansion joints and points to note

Expansion joints (hereafter, EXP. J) are used to prevent harmful behaviors in terms of structure. Effective dimensions as well as functional and efficient details of EXP. J are important for disaster prevention, function, and appearance.

### Building elements that need EXP. J

EXP. J are used to control harmful behaviors in terms of structure caused by fluctuating factors including external forces such as earthquake and wind, temperature change, drying shrinkage, and differential settlement and to ensure structural safety, functions, and good appearance. The following eight building elements need EXP. J, and attention should be paid to each behavior.

1. Connecting parts between buildings with different vibration characteristics. For example, connecting parts between buildings of a greatly differing number of stories, between blocks of different structural forms, etc. (Figure 1a)).
2. Connecting parts between buildings of different structure types or forms, such as steel structures and RC structures (Figure 1b)).
3. Connecting parts between buildings built on different geological ground conditions or on different thicknesses of weak strata, as well as the connecting parts between portions of a building built on different foundation types (Figure 1c)).
4. Connecting parts between the constituent buildings of an irregular-shaped building (Figure 1d)).
5. Very long buildings for which deformation due to temperature change or drying of concrete is of concern (around 80 m for RC buildings) (Figure 1e)).
6. Connecting parts between an existing building and extensions (such as a connecting corridor and the main building) (Figure 1f)).
7. Atrium roof and any corridor connecting separate buildings (Figure 1g)).
8. Periphery of a base isolated building and its connecting part to an adjacent building (Figure 1h)).

### Required dimensions

The effective dimensions of EXP. J are determined depending on the building height, and the required dimensions are calculated as a sum of the deformation amounts of the blocks. The deformation amount of a block varies widely depending on structural types and forms. For example, a Rahmen structure needs a clearance width of  $1/100+1/100=1/50$  of the building height. Therefore, a building with a height of 20 m needs a clearance of 40 cm or more. For super high-rise buildings with a height of 60 m or more it is required to validate the deformation amount by a time history response analysis. When an EXP. J is placed below the ground level between wings, the displacement amount of the ground should be considered (20 to 60 cm).

Design clearance for the periphery of a base isolated building should be thoroughly assessed because it varies depending on the system and performance criteria of devices (generally, around 60 cm).

### Required performance

It is important that any EXP. J should not be damaged by a small or medium earthquake, and EXP. J covers and finishing materials should not fall off at the time of a great earthquake. Especially, attention should be paid to ensure fail-safe systems, etc. so that the EXP. J of ceilings or floors do not injure humans at the time of evacuation. In addition, an EXP. J should have adequate clearance for temperature changes and differential settlement so that finishing materials can follow, as well as having a mechanism that enables easy repair and replacement, because damage to an EXP. J should be repaired to prevent any leaking by rain.

In addition to the above, performance standards of fire resistance, durability, and water-tightness, etc. are required for EXP. J. To meet the requirement of fire resistive performance, both sides of an EXP. J should be covered with steel or stainless steel plate with a thickness of 1.5 mm or more, and filled with a noncombustible material such as rock wool. The following characteristics of noncombustible material should also be considered. Regarding durability, it is important that any deteriorated sealing compound can be refilled without removing the EXP. J covers. When aluminum, stainless steel, etc. is used, the contacting surfaces of different metals should be protected to prevent rust or corrosion. Regarding water-tight performance, mechanisms that ensure water-tightness should be adopted to prevent the leakage of water into rooms. In addition, simple detail should be used so that any EXP. J can be easily installed, then repaired or replaced part by part with minimum disturbance.

### Examples of damage

Much damage to EXP. J was reported in recent earthquakes. Instead of letting manufacturers alone solve the problems, designers themselves should consider and validate the following capacity of EXP. J in both the horizontal and vertical directions. Possible causes of damage are given below.

1. EXP. J could not follow the building's deformation, and finishing materials deformed or fell off (Figure 2a) and 2b)).
2. The gap of EXP. J was too narrow, buildings collided and damage of structure increased (Figure 2c)).
3. Obstacles were placed around EXP. J during repair work to the existing building, etc. without thoroughly understanding the behavior of EXP. J, resulting in damage.

### Explanation to clients

Clients should be informed that EXP. J work at the time of an earthquake, and it is necessary to check deterioration of the jointing part, and ensure obstacles placed around EXP. J during maintenance will not prevent EXP. J functioning. It should also be explained that finishing materials may be damaged at the time of a great earthquake so that the building structure is not damaged.

(Akiko Yamaguchi)

□Source of figures

1) Edited by Architectural Institute of Japan, Preliminary Reconnaissance Report of the 2011 Tohoku-Chiho Taiheiyō-Oki Earthquake, 2011

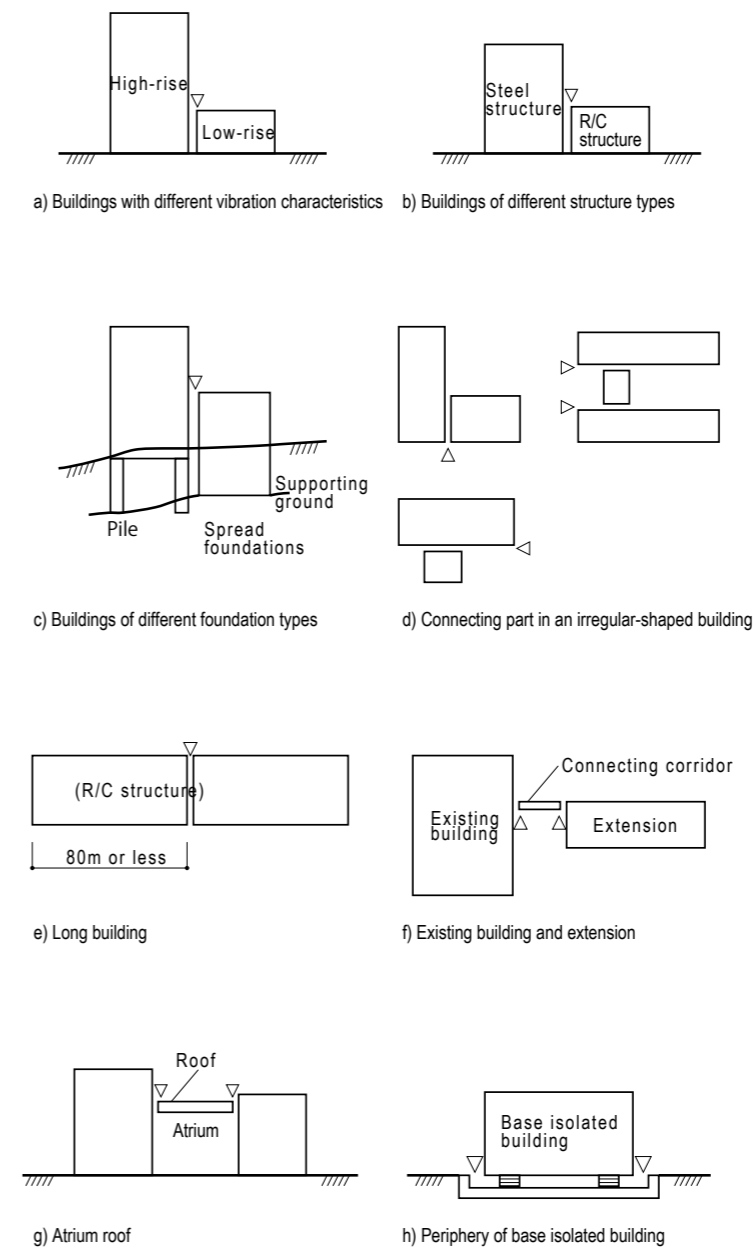

Figure 1. Positions of expansion joints



a) The ceiling finishing panel of an EXP. J has peeled off (photo: Satoru Ishiyama, Akita Prefectural University)<sup>1)</sup>



b) Deformation of a wall finishing panel of an EXP. J (photo: Tsuyoshi Seike)

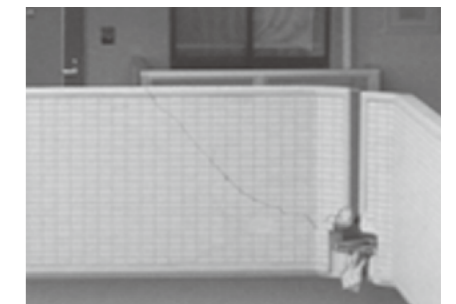

c) Collision of handrail walls caused by an EXP. J narrow gap (photo: Teruhisa Tanaka)<sup>1)</sup>

Figure 2. Examples of damage in expansion joints

## 7-5 Benefits of basements and points to note

Increased embedment of a building with a basement not only is effective for reduction of seismic force input but also may be effective for the design of piles and countermeasures against liquefaction. However, adequate attention should be paid to the planning because underground work is expensive and takes time.

### Effectiveness of a basement for earthquake resistant performance

It has been demonstrated by the records of past earthquakes that the existence of a basement is effective for increasing the earthquake resistant performance of a building.

Inertia force which acts on the foundation is reduced by underground earth pressure resistance and frictional resistance. When seismic motions with a different phase act on a highly rigid foundation, input of seismic motions are reduced because the foundation restrains these motions.

When seismic motions act on a building, these two reduction effects simultaneously arise. When the building is buried deep in the ground with a basement, input of seismic motions to the superstructure can be further reduced (Figure 1).

This fact is also considered in a formula to calculate the structural seismic index  $I_s$  in seismic diagnosis.  $I_s$  is expressed by the following formula.

$$I_s = E_D \times S_D \times T$$

The greater this value, the better the earthquake resistant performance ( $E_D$ : strength index,  $S_D$ : shape index,  $T$ : time index). When a building has a basement, the shape index  $S_D$  is greater by 20% compared with a building with no basement, and therefore increases the value of the structural seismic index  $I_s$ .

A basement generally increases the rigidity of a building because it has thick underground external walls that resist water pressure and earth pressure, and in many cases slits are not made in interior walls. In addition, a basement lowers the position of the building's center of gravity, and the embedment can protect against overturning and uplift as well as offer a restraining effect against deformation at the time of an earthquake. An appropriate embedded depth is generally 1/12 of the building height  $H$  or more. When a basement is made, this value is met in most cases.

### Other benefits

After the Miyagi Earthquake in June 1978, standards on the earthquake-resistant design of foundation structures were revised. According to the design guidelines published by the Building Center of Japan, when the embedment is 2.0 m or more, horizontal force applied to the pile head can be reduced by the ratio calculated with the formula below and within a range not exceeding 0.7 ( $H$ : building height above ground,  $D_f$ : embedded depth of foundation, 2.0 m or more) (Figure 2).

$$\alpha = 1 - 0.2 \times \frac{\sqrt{H}}{\sqrt{D_f}} \quad (\alpha \leq 0.7)$$

In the case of a building built on sloping ground, a basement would add frictional resistance of a foundation base and the passive earth pressure resistance of underground external walls, which can be a countermeasure against sliding (Figure 3).

When a bearing stratum is shallow, a basement often enables spread foundations. If the cost of this case is compared with the cost of pile foundations, when the pile length is short and the allowable bearing capacity should be reduced, the cost of spread foundations may exceed the other.

Regarding liquefaction, which became a great issue at the time of the Tohoku Earthquake on March 11, 2011, a basement discharges a liquefaction layer right under the building, and can reduce the liquefaction effect on piles (Figure 4).

### Points to note for planning a basement

To be structurally effective, a basement is required to be fixed firmly to the ground and have adequate rigidity. It should be noted that a basement as defined in the Building Standard Law of Japan (a story whose floor level is below the ground level and the height from the floor to the ground is 1/3 of the ceiling height or more) has no relation with this requirement (Figure 5).

Basements may be subject to earth pressure on only one side depending on the condition of the surrounding ground. In this case, it is required to consider sliding because an imbalance in horizontal force may occur. When the basement is supported by spread foundations, frictional resistance of the foundation base can be expected. On the other hand, when the basement is supported by pile foundations, horizontal force due to earth pressure should be considered in the proportioning of sections (Figure 6).

Because underground external walls are subject to eccentric earth pressure and water pressure, they have great thickness and thus function as shear walls. Therefore, any seismic force that acts on stories above ground is borne by underground external walls at the periphery, and the first floor slab is required to have rigidity and strength that enable them to propagate seismic force to the periphery (Figure 7). In addition, the construction load of the ground floor slab should be considered in the design because the ground floor is often used as a work yard.

For a basement, it is not mandatory to consider the story stiffness ratio and modulus of eccentricity mentioned in Section 7-2 and 7-3. However, in the case that only a limited part of the whole plan is a basement, attention should be paid in planning because it may be that the positions of the center of gravity and the center of rigidity are different and torsional behavior arises, and damage caused by excessive deformation and stress concentration occurs.

Piles or building frames remaining underground sometimes become problems depending on the site.

In these cases, if the building is planned avoiding such building frames, etc., designing with controlled construction costs becomes possible. When the building is planned using such building frames, it is necessary to appropriately evaluate the strength and damage.

Careful consideration on underground work is necessary because works which require cost and time, including earth retaining, excavation, removal of surplus soil, and drainage may account for a large portion of the cost of underground work, and may greatly affect the total construction costs. In the case of buildings with a considerably great volume of underground parts compared to the part above ground, buoyancy due to water pressure acts on the whole building depending on the ordinary groundwater level. Therefore, attention should be paid to countermeasures, etc.

(Kazuhiro Yamasaki)

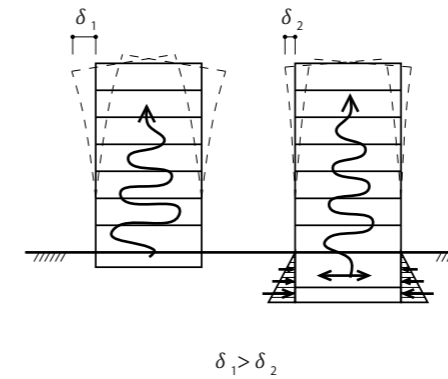
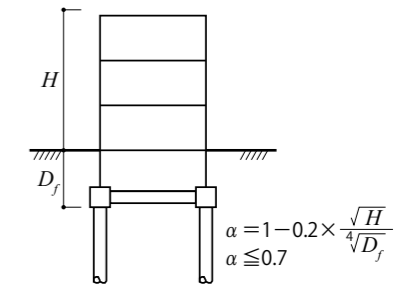

Figure 1. Reducing effect on the input of seismic motion



$\alpha$ : horizontal force sharing ratio of embedment  
 $H$ : building height above ground (m)  
 $D_f$ : embedded depth (m), applied when  $D_f \geq 2m$

Figure 2. Horizontal force sharing ratio of embedment

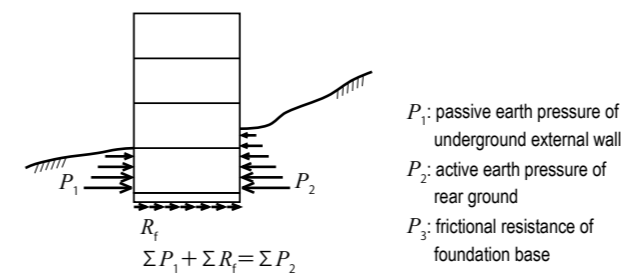

Figure 3. Basement which is effective as a countermeasure against sliding

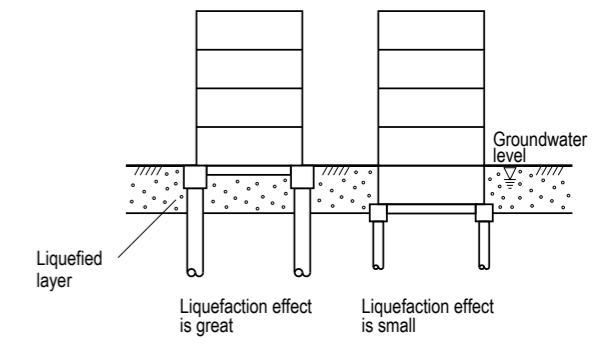

Figure 4. Liquefaction effect on piles

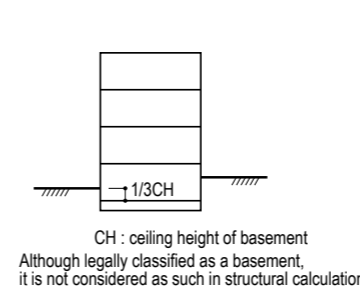

Figure 5. An example of a structurally ineffective basement

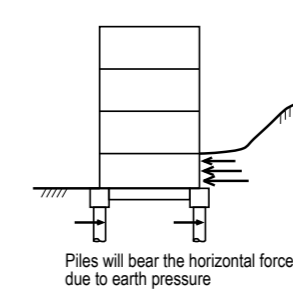

Figure 6. A building subject to earth pressure on one side

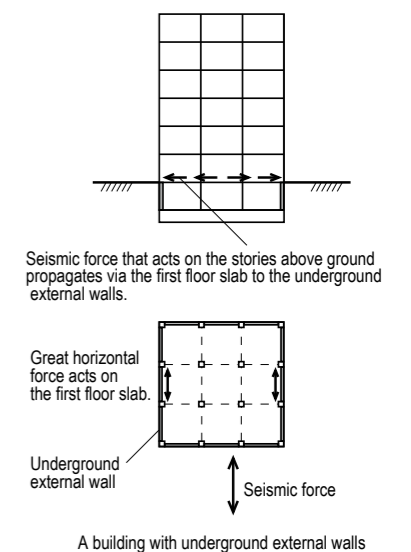

Figure 7. Horizontal force which acts on the first floor slab

## 7-6 Other points to note

This section discusses some practical structural issues which sometimes occur and to which architects should be aware. To balance earthquake resistant performance and design, it is important that architects and structural designers thoroughly discuss the issues; to this end it is better for them to cooperate to the fullest extent with each other.

### Detail of earthquake-resistant slit and joint

Earthquake-resistant slits are used to improve the rigidity balance of buildings or to ensure the deformation performance of columns, beams, and walls.

In order to prevent the inhibition of deformations of columns at the time of a great earthquake, the width of vertical slits are usually set as about 1/100 of the inside height of columns, the story height reduced by the beam depth. For an apartment house, it is generally set as 20 to 25 mm (Figure 1). On the other hand, a vertical slit width of more than 40 mm is sometimes required at lower stories with great story heights such as the ground floor. Therefore, the required width of slit varies depending on stories.

The width of horizontal slits is set as a constant value of 20 to 25 mm regardless of the inside height of columns. Although this value has no problem as clearance between structural frames, whether the detail of the joint can follow the deformations of frames or not needs to be considered. Please note that when the detail of a joint cannot follow the deformations, tiles on the exterior wall around the joint may be detached and fall off during a medium or greater earthquake. After the 2011 Tohoku Earthquake, such damage was observed throughout the area.

### Connection with a projected EV core

When elevators and stairs are projected from a building frame (Figure 2), the projected part and main building frame vibrate differently during the earthquake. Therefore, attention should be paid to the following points in planning the connection. When the projected part and the main building frame are separated by EXP. J, an adequate clearance and EXP. J detail which will not be damaged should be ensured, and a safe evacuation route must be secured. When the projected part and main building frame are planned as an integral structure, tremendous force is applied to the floor at the connection. Countermeasures such as slab strengthening and placing beams based on appropriate calculations are effective for the prevention of structural damage.

### Multi-story opening in a multi-story wall

When there is a multi-story opening in a multi-story wall (Figure 3), it should be treated as either a non-structural wall by setting earthquake-resistant slits, or a shear wall. When it is treated as a shear wall, structural calculations should be made supposing studs and shear walls on both sides of the openings and boundary beams. Therefore, any boundary beam is subject to great shear force, and the through-hole of the beam is limited.

### Columns on a beam span should be avoided as much as possible

When planning a column on a beam span in a setback building (Figure 4), the number of stories supported by the col-

umn should be minimized because it may be damaged by a great earthquake; generally to one or two stories. In addition, the beam which supports the column should have adequate strength. Therefore the section of the beam should be greater and the through-hole is limited.

### Problem of a large wellhole

When a building includes a large wellhole, as in Figure 5, the area of rigid floor of the story is different from other stories, and seismic force propagated from the upper stories is redistributed within this story. This causes an imbalance of stress, and problems of secondary stress including the in-plane shearing stress of slab and axial force of beams occur. In addition, because columns become independent posts, the horizontal rigidity of the wellhole part decreases. As a result of addressing these structural problems, the construction cost increases.

Attention should be paid when the size of the wellhole is about 1/8 of the plan or greater, as well as when the wellhole is three stories or more.

### Aspect ratio should be 4 or less

A structural problem of a tower-shaped building is overturning. Because this type of building is subject to rocking vibration at the time of an earthquake (Figure 6), the fluctuating axial force increases and the allowance of columns against the axial force decreases. To prevent overturning, the burden on the foundation structure increases. Adequate embedment or making a basement is effective.

The aspect ratio (eaves height  $H$  / short side length  $D$ ) should generally be 4 or less. When the ratio exceeds 6, the building must undergo a performance evaluation before confirmation of the building construction.

### Building supported by 4 columns

A building with a small number of columns has fewer degrees of statical indeterminacy, and the building as a whole is prone to become unstable by the fracture of just a few members. Therefore, it is important to err on the side of caution in terms of structural calculations, and include the consideration of diagonal seismic force and the addition of seismic force.

### Long span beam

The economical span of office buildings and apartment houses is generally 6 to 8 m. Office buildings, etc. with a steel structure sometimes use long span beams with a length of about 15 to 20 m to create a large space without columns (Figure 7). RC structures can have long spans up to around 20 m by adopting prestressed concrete beams. The problem in this case is a cost increase that stems from measures to meet the disturbance caused by vertical vibration and variations in stress due to the unequal span. It is important to make the area borne by beams as small as possible by such means as ensuring adequate beam depths and making the span of perpendicular beams short.

Some issues which occur on a practical level have been discussed. Architects should recognize structural problems that can lead to cost increases, and share such issues with structural designers. *(Shinichi Ara)*

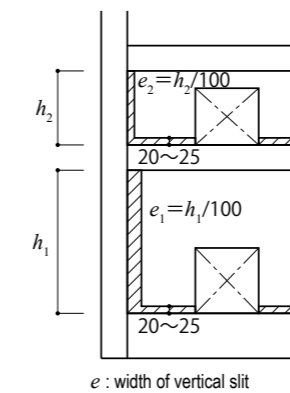

Figure 1. Width of earthquake-resistant slit

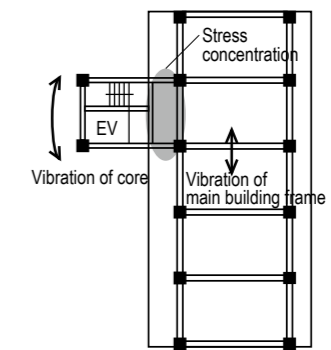

Figure 2. EV core projected from main building frame

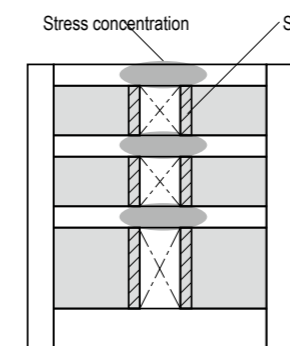

Figure 3. Multi-story opening

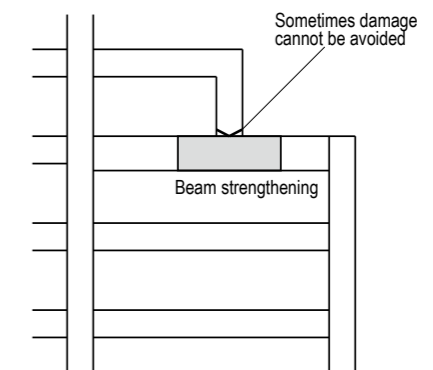

Figure 4. Column on beam

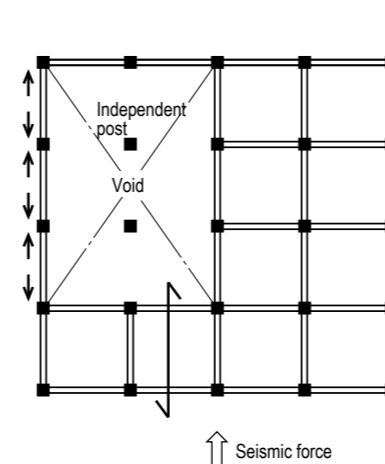

Figure 5. Problem of a large wellhole

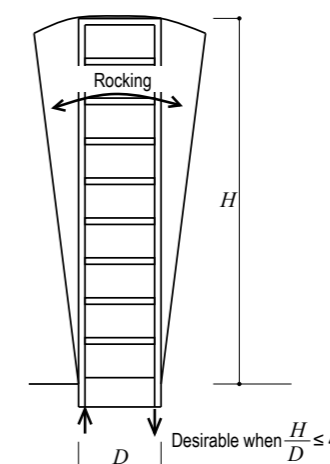

Figure 6. Aspect ratio

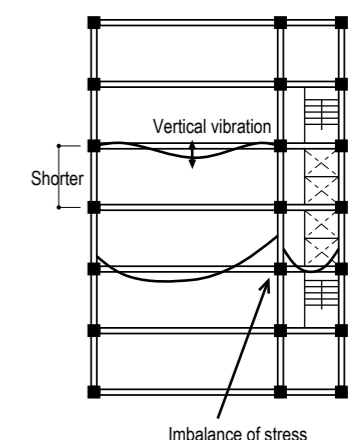

Figure 7. Long span beam

## 8 Earthquake-resistant Design of Non-structural Building Elements

### 8-1 Expanding the earthquake-resistant design from the building frame to non-structural building elements

To ensure the earthquake-resistant performance of buildings as a whole, it is important to ensure the integrated balance of earthquake-resistant performance of not only building frames, but also building elements and members. The consistency of equipment and elevators and methods of fixing furniture are also important factors.

#### Awareness of earthquake resistance of non-structural elements

The Great East Japan Earthquake caused extensive damage, not only to the coast of the Tohoku region which was greatly affected by the following tsunami, but also the areas around Tokyo suffered damage from the earthquake. Blackouts lasted for a considerable time, and many commuters were unable to return home. Super high-rise buildings rocked hard, many elevators stopped, office documents were scattered, and ceiling panels broke free (Figure 1). All the ceiling panels of an auditorium fell off and the damage took a year to repair. The ceiling panels of the Kudankaikan building, constructed before World War II, fell off killing two people; this event clearly demonstrated to the public that even when a building frame suffered no damage, not only functions but also human life can be lost by damage to the non-structural elements.

#### Types of non-structural elements

The term non-structural element is a wide ranging term, and refers to all building elements except the building frame, and includes exterior wall and opening (fittings and glass), partition walls, finishing materials of ceilings, floors, roofs, etc. and equipment. It is categorized into two main types: choheki meaning a curtain wall that constitutes a wall by itself, such as a curtain wall and ALC panel (Figure 2), and secondly, finishing materials that are attached to building frames, such as tiles and stone facing (Figure 3).

#### Earthquake resistance of non-structural elements

Depending on the acceleration, velocity, and relative story displacement from the building frame, damage to the interior and exterior finishing materials varies, from minor to extreme. Organizing information on the relationships between the state of damage suffered by elements and the degree of shaking at the time of an earthquake can help to more comprehensively understand the earthquake resistance of buildings. Information on the earthquake resistance level of non-structural elements by building element can be found in Table 1 of Section 5-5. However, because early restoration has been assigned the highest priority after an earthquake, it has not been possible to conduct well-organized examination of the Great Hanshin-Awaji Earthquake and subsequent earthquakes. Unfortunately, there is no detailed catalogue of engineering information available for designers. Today, the general public has recognized that the earthquake resistance of buildings requires more than just ensuring the structural strength to protect human lives. With regard to ceilings and other non-structural elements that were damaged in the 2011 Tohoku Earthquake, investigation to determine the causes, and study on countermeasures are being considered at the national level.

Although not in the case of a very severe earthquake with

a seismic intensity of 7, such as the Great Hanshin-Awaji Earthquake, if an earthquake with a seismic intensity level of 6 or 5 were to occur in an urban area now, it is doubtful whether the building functions needed by a typical domestic home can be maintained. Regarding structural issues, structural standards have been reviewed and revised after great earthquakes which caused unexpected damage. After the Great Hanshin-Awaji Earthquake and the Great East Japan Earthquake, it was found buildings built to the standards for earthquake resistant-design established after 1981 experienced limited damage to building frames as a whole. It can be said that earthquake resistance levels for the protection of human lives were ensured.

#### Structure systems and damage of non-structural elements

Even with the same seismic motion, the way a building absorbs seismic energy or the way it shakes, varies depending on the structure system. If a building is made rigid with shear walls, non-structural elements will be directly affected by an earthquake. In contrast, when seismic isolators are installed between the ground and the building, seismic energy is absorbed and the effect of the seismic energy on the building above the seismic isolators will be reduced. The way to assemble non-structural elements varies depending on the structure system. Therefore, it is important to determine an appropriate structure system according to the purpose of the building.

#### Relationship between damage and the construction process of non-structural elements

The numerous different kinds of non-structural elements are installed through a long list of processes. For example, ceilings, which became an issue at the time of the Great East Japan Earthquake, are constructed by carefully following many different procedures. A typical process is as follows.

1. Determine the layout of equipment, and then determine the appropriate positions to drive in inserts from which to hang the ceiling panels.
2. Determine the ceiling plan.
3. Set the inserts on forms.
4. Ensure correct pouring of the concrete.
5. Confirm that inserts are properly mounted, attach hang bolts, furring brackets, and furring, attach anti-vibration fittings, and strengthen openings such as those for air outlets and lighting fixtures.
6. During this time, install equipment instrumentation in the ceiling and attach anti-vibration fittings, in such a way as to avoid contact between those instruments which vibrate differently due to differing natural periods.
7. Attach ceiling finish materials.
8. Install equipment instruments.

As described above, eight kinds of work are carried out sequentially.

Ceilings are subject to gravity at all times, and if just one ceiling panel breaks free, this requires the adjacent elements to bear an additional load. If these elements are unable to bear the extra load, they too fall off in a chain reaction, leading to ceiling collapse. Because non-structural elements require many kinds of tasks in their installation, a steady succession of such work is required.

To ensure earthquake resistance, understanding both

building frames and non-structural elements as a whole, and ensuring the diligent completion of each process from design to construction is required

(Junichi Nakata)

□Source of figure

1) Institute for Fire Safety & Disaster Preparedness, Database of disaster photographs  
[http://www.saigaichousa-db-isad.jp/drsdb\\_photo/photoSearch.do](http://www.saigaichousa-db-isad.jp/drsdb_photo/photoSearch.do)



Figure 1. In this school gymnasium large amounts of ceiling materials fell off (the Great East Japan Earthquake, Sakae-mura, Nagano prefecture)<sup>1)</sup>



Figure 2. Collapse of an ALC panel (the Great Hanshin-Awaji Earthquake)



Figure 3. Damage to tile finishing which had been directly attached to the building frame

## 8-2 Prevention of falling glass. e.g. windows, partitions, etc.

If glass panes and the like fall at the time of an earthquake, they can cause extensive damage, and they are likely to fall not only in giant earthquakes. Measures to prevent the breaking and falling of glass, and not just for curtain walls, should be considered at the design stage. Vertical seismic coefficients should also be considered (Figure 1).

### To prevent falling glass in an earthquake

Falling glass during an earthquake is highly dangerous and causes extensive damage. During the 2005 Fukuoka Earthquake, glass panes fell on to busy streets due to hardened putty; it would appear the deformation of window frames directly affected the glass. First of all deformation of frames should be reduced, and secondly, adequate space between the frame and the glass, known as edge clearance, should be ensured. Any sealing compound has to be elastic and able to follow the deformation. A fixed window has an especially small clearance. In the case of a corner window using perpendicularly butting glass, glass panes are prone to collide; details to prevent such collisions should be considered. A movable window has an advantage over a fixed window because there are gaps to the frames; however, it is important to check the hinge can follow any deformations during an earthquake.

### Bouwkamp's formula

The standard dimensions of edge clearance required to ensure earthquake resistance performance are generally determined depending on the thickness and type of glass<sup>(1)</sup>, as well as being calculated by a formula assuming glass rotation within a frame (Bouwkamp's formula, Figure 2). It should be noted that recently thick glass, such as double glazing for energy saving and laminated sheet glass for safety, is becoming popular. Therefore, it should be appreciated that there is a limit to designs for realizing the slim appearance of frames.

### Deformation Following Ability

Assuming the deformation of building frames is inevitable, it is important for glass curtain walls to minimize the deformation of non-structural elements which are attached to the frames. Glass cannot withstand the forces of an earthquake unless it is set within an appropriate frame. Points to note for the configuration and deformation of glass frames of main curtain wall types are as follows.

#### 1. Pnael type (unit sash)

Units with embedded glass and panels are fixed at both upper and lower floor slabs. This type is required to have some rigidity. In terms of the method to let seismic force escape, in the example of PC curtain walls, there are two methods, the swaying type and the more popular rocking type.

#### 2. Spandrel type

Panels (including PC panels, etc.) are fixed at walls of waist height (spandrel), and glass is installed in between. It is likely that relative story displacement concentrates on the top and bottom edges of window glass. Therefore, adequate edge clearance to the frame should be ensured. The same attention should be given to the "column and beam type" that configures columns and beams using panels, because panel parts should follow the movement of the building frame.

#### 3. Mullion type

Mullions are fixed between the upper and lower stories, then window frames or panels are fixed to mullions, and glass is embedded. In the case of this type, an appropriate detail should be devised for the part attaching the mullion to the floor slab. It is generally treated as a rotation type and edge clearance is considered as for window frames.

### Points to note for the adoption of DPG building construction

DPG (Dot Point Glazing) building construction, in which tempered glass is fixed at points, was not very popular at the time of the Great Hanshin-Awaji Earthquake. Because no frame for the glass is used, points supporting the fitting have a device to reduce stress concentration; the swaying and rocking of the glass lets the relative story displacement out. After the Great East Japan Earthquake, some damage was observed, indicating the method seems to be able to follow relatively-large deformation, but has a limit. In terms of earthquake resistance, it is important to control deformation as a whole, so that each supporting point does not experience great displacement.

Tempered glass is used because, in principle, holes are made in the glass. In addition, an anti-shattering film must be applied to the glass in order to prevent secondary damage. This is also effective for preventing the natural explosive fracturing of tempered glass. Furthermore, the use of laminated sheet glass is desirable.

### Glass screen building construction

Walls using glass screen building construction (Figure 3) which is often used for auto showrooms, though not curtain wall construction, suffered damage in not only the Great Hanshin-Awaji Earthquake, but also the Great East Japan Earthquake. Several reasons have been considered, including great deformations were produced because the spans of steel frames were long, or clearances between mullion glass and plate glass were too little because they were abutting each other, or that glass plates were perpendicularly butting at corners. To prevent such damage, adequate edge clearances and clearance dimensions between glass as well as adequate bearing widths with frames should be ensured. When a story deformation angle is not indicated, it should be 1/100 or less, and cooperation with a structural designer is needed.

### Countermeasures for long-period ground motion

The Great East Japan Earthquake is known for the phenomenon of "long-period ground motion," where the long-period component of seismic motion propagates to remote places and makes buildings with long natural periods such as super high-rise buildings and base isolated buildings resonate and rock like a ship. At this time deformations of buildings may become greater, and furniture on casters may move and cause damage. To prevent such damage to curtain walls, fasteners should be ensured to be capable of bearing such movement, and to prevent the movement and collision of furniture, etc. against glass. It is desirable to install spandrel walls instead of full-height glazing and to attach handrails. In addition, depending on circumstances, the selection of glass taking into account the likelihood of the collision of objects may become necessary.

(Taiki Tomatsu)

#### □Note

(1)Unless otherwise specified, the "Japanese Architectural Standard Specification for Glazing Work (JASS 17)" issued by the Architectural Institute of Japan and recommendations by glass manufacturers should be followed.

#### □Reference

(1)Public Buildings Association, Kenchiku kouji kanri shishin (Guidelines for building construction supervision), edited by the Government Buildings Department, Minister's Secretariat, Ministry of Land, Infrastructure, Transport and Tourism, 2010

#### □Source of figure

1) The Japan Building Disaster Prevention Association, "Anzen anshin garasu sekkei seko shishin (Safety/Security: guidelines for design and construction of glass work)," February, 2011

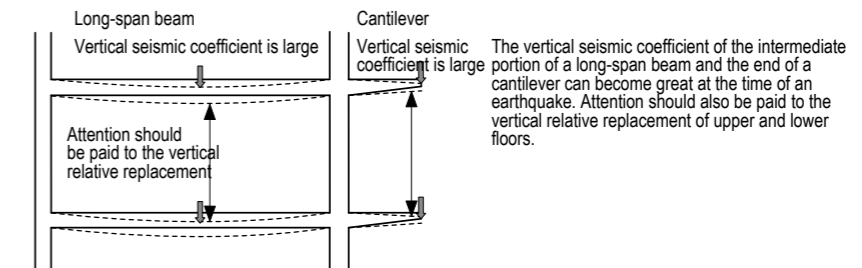

Figure 1. Vertical motion at the time of an earthquake

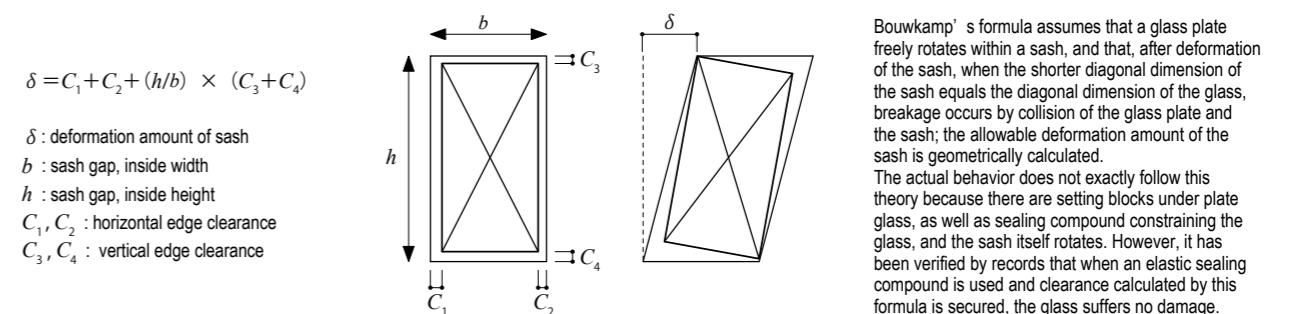

Figure 2. Bouwkamp's formula<sup>1)</sup>

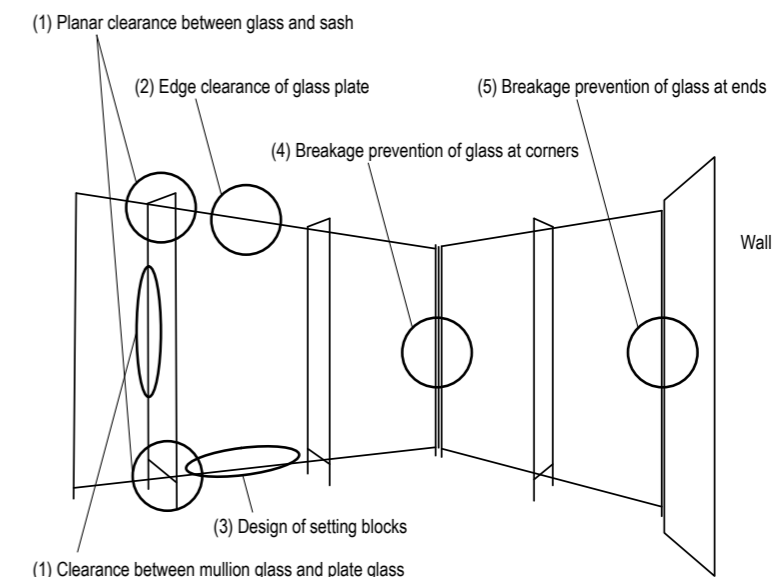

Figure 3. Dimensions around glass plate in relation to earthquake resistance<sup>1)</sup>

### 8-3 Design and performance of curtain walls

Curtain walls have been commonly used for the exterior finishing of high-rise buildings and especially great efforts have been made to ensure their earthquake resistance performance. It is desirable that architects pursue design freedom in cooperation with manufacturers and building owners while considering not only design but also the performance of earthquake and wind resistance, and water-tightness.

#### Types of curtain wall

Curtain walls or choheki (CW, hereinafter) are classified into the metal type and precast concrete (PC) type. Although glass and frame are common to both types, the main difference is whether wall panels with full-height or a waist height (spandrel) are made of metal (such as aluminum) or concrete. There is a great difference in weight per unit area, and devices in terms of structure and earthquake resistance have individual characteristics. Another type of curtain wall uses glass all over (glass CW). Therefore, this section discusses points to note for the earthquake-resistant design of curtain walls including DPG building construction. The PC type includes fewer components, has a variety of finishes including tile, stone, and paint, and is less expensive; in contrast, the metal type including glass CW gives an airy and light impression to a building, consequently designers have a range of options.

#### Ready-made CW and custom-made CW

CW includes ready-made CW (including semi-readymade CW with some flexibility of design), which is usually used in relatively low buildings, and custom-made CW, which gives designers freedom of design. The performance of ready-made CW has been sufficiently examined and clearly explained; custom-made CW has to be developed by the designer in cooperation with the manufacturer's engineers because its performance should be specified and ordered including its design (performance specification contract). Designers have to pay adequate attention to not only setting but verifying the performance required for the CW, as in return for their freedom of design, they take responsibility for the engineering aspects and earthquake-resistant design; consequently they must develop their expertise in all aspects of CW.

#### Prevention of damage during an earthquake

In the Great Hanshin-Awaji Earthquake, many PC type CWs suffered damage though such damage was not very severe in the Great East Japan Earthquake (Figure 1 and Figure 2). As the CWs following earthquake resistance standards established after 1978 suffered less damage, it is essential that the building frame itself does not experience great deformation. In addition, some devices should be prepared so that CW, as a non-structural element, can avoid damage by being subject to a great force. CW itself is easily broken by an external force because it has less strength than a building frame. It seems that metal type and glass type CWs suffered less damage. The reason may be that CWs of these types which include many elements could disperse forces more efficiently, or that their light weight did not produce great inertia forces, or that their metal members had a greater elasticity. However, those CWs whose building frames suffered great deformation suffered con-

siderable damage. It is necessary to make a comprehensive assessment of such matters.

#### Movements of building frames during an earthquake

First of all, the movements of building frames during an earthquake should be limited. In addition, regarding super high-rise buildings with a height of 60 m, relative story displacement, lateral and vertical seismic coefficients, etc. which are obtained from time history response analysis should be taken into consideration for structural design. Relative story displacement means the amount of displacement between vertically adjacent stories. It is usually about 1/150 of the story height. However, in the case of steel or flexible structures, it can greatly vary depending on earthquake characteristics and ground situation. Lateral and vertical seismic coefficients can vary even within a plane of a building, and gravity acceleration can become considerably great at long-span beams, the intermediate part of slabs, or the end of cantilevers. Moreover, vertical relative displacement between vertically adjacent stories may be produced. Based on these movements of building frames, movements of CWs should be assessed.

#### Movements of CW during an earthquake

CWs should move differently from building frames during an earthquake. In terms of the method to let the input seismic force out, the swaying (sliding) type or rocking type are generally used (Figure 3). Although PC type CWs are usually fixed to beams, etc., CWs should be too long, especially in the case of the rocking type. In addition, when they are fastened to beams, the relative story displacement should be concentrated on the top and the bottom of the windows. Metal type CWs which include a panel with high rigidity such as an aluminum casting panel may show similar movements to PC types.

#### Goals and points of earthquake-resistant design of CWs

Regarding responses at the time of an earthquake, there are two essential points to ensure. First of all, the finishing materials including glass will not fall off in a great earthquake. Secondly, CWs should be repairable and their functions are maintainable during not very great earthquakes. Specifically, these goals are indicated using the performance of following the relative story displacement, and generally 1/150 to 1/120 for steel structures and 1/200 for rigid structures are set as the goals. A value of 1/100 is sometimes set for super high-rise buildings with flexible structures, etc. Breakage of sealing compounds often allows a value around 1/300. However, these goals are just rough indications, and they should be set by considering types, importance, etc. of the building. Important points concerning the earthquake-resistant design of CWs are as follows.

1. Appropriate clearance to building frames should be ensured. Details that can absorb relative story displacement, including clearance around glass, should be considered.
2. Configuration and required strength of supporting metal fittings (fasteners) should be secured. Careful attention should be paid during construction to give fasteners sufficient movability. In addition, the strength of building frames that support the fasteners should also be verified.
3. Finishing materials should be appropriately attached, and secondary countermeasures for prevention of falling should be taken as appropriate. It is desirable to consider degrada-

tion over time.

4. Efforts should be made to conduct earthquake-resistant design which is consistent with architectural design. New building construction techniques including the weight saving of panes and devices for fasteners should be addressed, and conducting factual performance verifications including full scale experiments are desirable. (Taiki Tomatsu)

□Sources of figures

- 1) Sakamoto & Matsumura Laboratory, the University of Tokyo, A Report on the Damages of Precast Concrete Curtain Walls by the 1995 Hyogo-ken Nanbu Earthquake, 1996
- 2) Edited by Industrial Research Center of Japan, Kenchiku zairyō jitsuyō manyūaru jiten (Practical Manual Dictionary of Building Materials), Dictionary Publishing Center of Industrial Research Center of Japan, 1991



Figure 1. Collapse of PC CW



Figure 2. Falling of CW at a corner<sup>1)</sup>

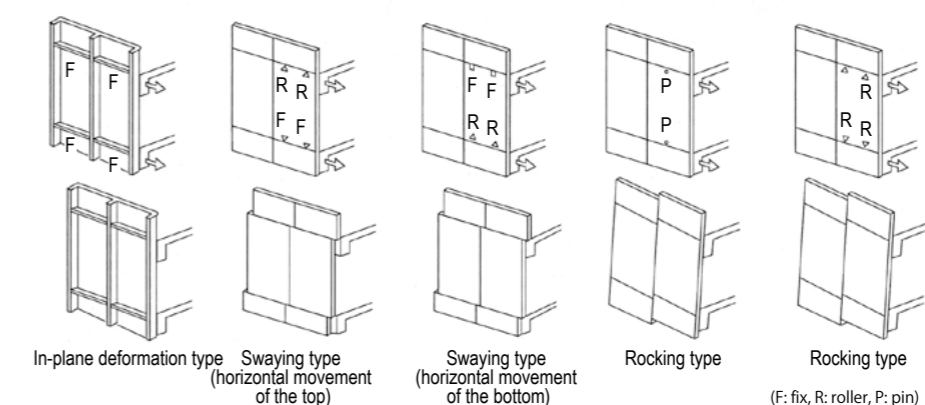

Figure 3. Methods for following relative story displacement<sup>2)</sup>



## 8-4 Earthquake-resistant design of ALC and paneled exterior walls

ALC is a popular material; it is produced under stringent control and has excellent workability. Even so, care should be taken when installing ALC panels because they are made of soft material; they should be installed so that they have flexibility to avoid constraint and damage at the time of an earthquake. When used for exterior walls it should not fall off, or as an interior wall it should not suffer damage, or affect a fire compartment during an earthquake. Please note, using it in the once popular rebar-inserted longitudinal wall construction poses risks.

### What is ALC?

ALC stands for Autoclaved Lightweight aerated Concrete. It is widely used in medium-rise buildings in urban areas in Japan, and many 3 to 4 story shops and houses are built using ALC. It is light, with high heat insulation properties and good workability. It is a versatile material, can be constructed in a short period and is not expensive. Although Japan has a tradition of wooden architecture, it seems that buildings with a steel frame and ALC panels have been readily accepted by the Japanese public. However, in many older buildings ALC has been incorrectly used; it is important to use this versatile material in an appropriate manner.

### Basically the same as PC

The earthquake resistance of ALC panels is similar to PC panels. To avoid constraint and damage, the rocking and sliding methods are commonly used. The difference between the two methods is the strength of the panel. ALC itself is a relatively soft material because it is aerated in order to make it lighter. Experts of details say that it should be treated like bean curd. Therefore, attention should be paid to the fittings for the fixing and method of attaching; it needs to be softly fastened.

### Longitudinal alignment and lateral alignment

The methods for attaching ALC panels include rebar-inserted longitudinal wall construction, longitudinal wall sliding construction, longitudinal wall rocking construction, lateral wall cover-bolting construction, lateral wall bolting construction, and lateral wall rocking construction (Figure 1 and Figure 2). Among them, since around 2002, longitudinal wall rocking construction has become popular as standard for earthquake-resistant building construction. However, rebar-inserted longitudinal wall construction is still often seen; this method bears any loads just by means of rigidity, whereas earthquake resistance is also considered for other building construction types. Even after the Great Hanshin-Awaji Earthquake, many buildings using this construction method suffered damage. It is known problems in the details of its attachment to steel frames or in the supervision of any welding work, may directly lead to the falling of panels. The low cost of this method made it popular, resulting in many buildings, which need to be monitored (Figure 3 and Figure 4).

### Points for earthquake-resistant design of ALC

ALC has stable performance because it is produced under well-controlled factory conditions. ALC is manufactured to order by sales and construction firms, and in principle is guaranteed against defects for a specific period. Since the 1978

Miyagi Earthquake, standards for earthquake-resistant design have been improved many times. By basing their design on a manufacturer's manual, a designer can ensure a safe and creative design, although sections connecting with other systems are prone to cause problems. Close attention should be paid to the supervision of steel work, welding work, and sealing work, as well as the fitting of finishes such as tiles, connection to sash, continuity with fire compartments, and so on. These are all sections for which designers bear a share of the responsibility and all require careful attention.

### Finishes for ALC

ALC is a high water-absorbent material with low strength, and when used for an exterior finish, a water-nonabsorbent, thinly spreadable, and light material is needed. An elastic spray painted finish is ideal, but, a tile finish is often demanded, which requires the selection of materials and construction in accordance with designated specifications and construction standards. In recent years, ALC panels with a textured pattern on the surface have been produced. As mentioned, quality control ensures factory painted ALC panels have good appearance and performance.

### Ways of interior use

ALC is commonly used for interior walls because of its low cost and good workability. It is often used for partition walls, shaft walls and staircase walls, many of which also make up fire compartments. Many such interiors using ALC panels suffered damage from the Great Hanshin-Awaji Earthquake. Moreover, at the Great East Japan Earthquake, damage was caused by long-period quakes at locations some distance from the focus. Many of the panels were broken by collisions against adjacent concrete walls or curtain walls. In terms of earthquake resistance, details that can let seismic force out by moving are required. Details that can maintain the functions of fire compartments even when a certain degree of damage is produced are also required. In the case of finishes which used GL construction, gypsum boards bonded with adhesive fell off and peeled the finishes of ALC because the strength of panels was low. Improvements to materials and construction methods are required.

### Extruded cement panels

In the case of longitudinal construction, extruded cement panels normally follow the deformation of the building frame by rocking, and in the case of lateral construction by sliding. Attention should be paid to the fact that extruded cement is harder than ALC.

### What to do with existing buildings

A lot of buildings have been built with ALC, and are often found in especially dense clusters in commercial and residential districts. Some of them are called tecchin apato (steel apartment buildings); the name was derived from the existing mokuchin apato (wooden apartment buildings). There are doubts concerning the structural earthquake resistance of old buildings of this type; in most cases, connections to steel frames cannot be verified because of fire resistant asbestos coverings. Countermeasures against this problem should be taken combined with tackling the issue of large-scale fires during an earthquake. However, the problem cannot be sim-

ply solved by treating a single building, it requires a broader approach by a community as a whole involving cooperation with architects, urban planners and public administration.

(Kazuo Adachi)

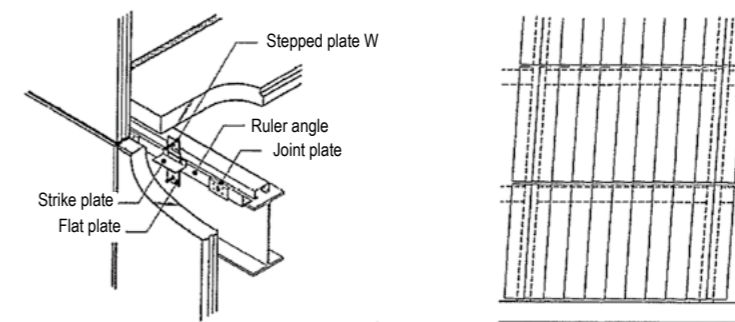

Figure 1. An example of an attachment for a longitudinal wall rocking construction and movement of panels at the time of relative story displacement<sup>1)</sup>

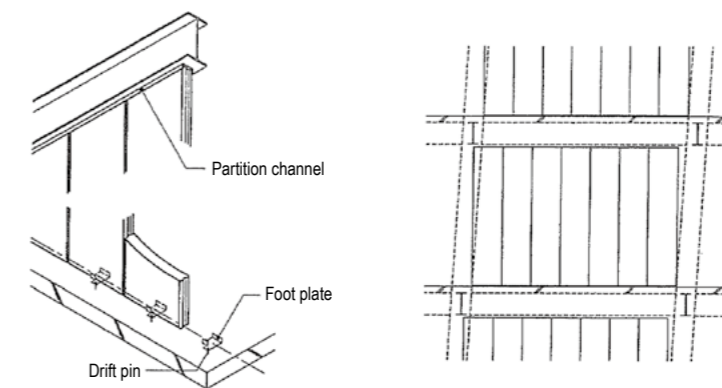

Figure 2. An example of attachment for partition wall construction and movement of panels at the time of relative story displacement<sup>1)</sup>



Figure 3. Ribbed ALC panels that fell during the Great Hanshin-Awaji Earthquake. The panels were of rebar-inserted longitudinal wall construction.



Figure 4. Damaged car park building for a commercial facility in Ofunato City, Iwate prefecture, caused by the Great East Japan Earthquake. Although the ALC panels suffered no damage from the earthquake, the tsunami broke through the wall and washed away the cars parked inside. This building was also of rebar-inserted longitudinal wall construction.

□Source of figures

1) ALC toritsuke koho hyojun dou kaisetsu (Standard Building Construction for Installing ALC and Interpretations), 2004, ALC Association

## 8-5 Prevention of ceiling collapse

Although a ceiling has no direct relation to structural earthquake resistance performance such as the prevention of building collapse, earthquakes have caused a lot of ceiling collapses, and the Great East Japan Earthquake even resulted in deaths. This building element cannot be missed in seismic planning. It is important to understand the mechanism of a collapse and how to prevent it.

### Ceiling collapses happen with every earthquake

The 2001 Geiyo Earthquake, 2003 Hokkaido Earthquake, 2005 Miyagi Earthquake, as well as the 2011 Great East Japan Earthquake, all caused the ceiling collapse of large buildings (Figure 1 and Figure 2). Though a ceiling is not a part of the main structure of a building, or not a building element whose damage leads to the building's collapse, ceilings are important because their collapse can result in death, injury and damage.

### Mechanism of ceiling collapse during an earthquake

Acceleration which acts on a ceiling at the time of an earthquake is generated by quaking of the building. Seismic force propagates from the ground to the building, via the backing of the ceiling, and to the ceiling finish. Ceiling collapse is caused, in most cases, by the breakage of clips connecting furring brackets fixed to hanging members and boarded furring. Why many ceiling collapses during an earthquake happen in large spaces such as gymnasiums also needs to be considered.

The force that acts on a structure during an earthquake relates to not only seismic acceleration but also the period of vibration. A building has its own natural period of vibration, and when it matches the period of the earthquake, the building resonates with the earthquake and quakes more strongly. A hung ceiling has a structure similar to a swing, and its period of vibration varies depending on the length of hang bolts. The longer the hang bolt, the longer the period of vibration. In some large spaces such as gymnasiums, the length of hang bolts exceeds 2 m. In such cases, the period of the ceiling is much longer than that of the building. As a result, the building frame and the ceiling quake differently, then the ceiling ends strongly collide with walls and are subject to great force, which deforms the ceiling as a whole, furring strips drop off one after another and the whole ceiling collapses. The ceiling collapse during an earthquake is related to the natural periods of the building and ceiling.

### Prevention of ceiling collapse

To prevent ceiling collapse, the backing of a ceiling should be strengthened first. As mentioned above, deformation of hung ceilings is caused by the swinging of hang bolts, acting exactly like a swing. To control this, strengthening by setting diagonal members (braces) between hanging members and furring brackets is necessary. Such diagonal members control deformation of the ceiling, as well as shortening its natural period.

In addition, it is effective to ensure adequate clearance by setting a gap between the ceiling and the walls to reduce the force that acts on the ceiling at the time of the collision between the ceiling and the walls (Figure 3).

It was reported that the ceiling collapse of Kushiro Airport Terminal Building at the time of the Tokachi-oki Earthquake

of 2003 was caused by a resonance, which was generated because the natural period had shortened due to setting braces in backings, and the earthquake had a similar period component. An earthquake can have different period components while it is occurring and during the process of propagation. Therefore, the most effective countermeasures are not only to ensure adequate clearance to walls but also to strengthen with braces. The guidelines "Measures against falling of ceilings in buildings with large spaces" prepared by the Ministry of Land, Infrastructure, Transport and Tourism in 2003 (October 15, 2003, Building Guidance Division, Housing Bureau, MLIT, No. 2402) are based on this policy (Figure 4 and Figure 5). Furthermore, after the Great East Japan Earthquake, countermeasures are being reviewed at present.

### Attention should be paid to any clipped ceiling

There are many cases where a space includes ceilings with different heights. In such cases, great deformations are usually generated at the connecting portions between these ceilings because they swing differently due to the varied lengths of hanging members. Building Guidance Division, Housing Bureau, MLIT, No. 2402 of 2003 gives instructions to strengthen the stepped portion to ensure rigidity, or to set a clearance between ceilings with different heights (Figure 6 and Figure 7).

(Tsunehide Takagi)

#### □ Sources of figures

- 1) Joint research by the Building Research Institute and National Institute for Land and Infrastructure Management, Summary of the field survey and research on the 2011 Off the Pacific coast of Tohoku earthquake (the Great East Japan Earthquake), 2011
- 2) The Japan Building Disaster Prevention Association, Guidelines and Examples of Seismic Retrofit of Existing Steel Gymnasiums, etc.



Figure 1. Damage to the ceiling at the top of a partition wall (the Great East Japan Earthquake, 2011)<sup>1)</sup>



Figure 2. Ceiling collapse and damage at a gymnasium (the Great East Japan Earthquake, 2011)<sup>1)</sup>

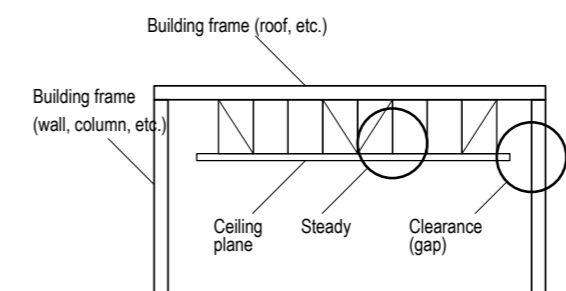

Figure 3. Steady brace and clearance (source: Building Guidance Division, Housing Bureau, MLIT, No. 2402)

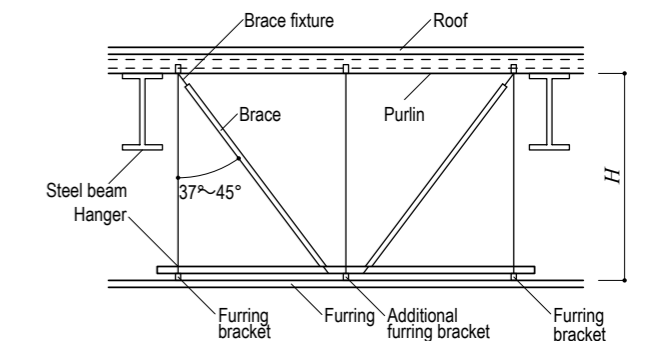

Figure 4. Strengthening of furring (H is 1,500 mm or less)<sup>2)</sup>

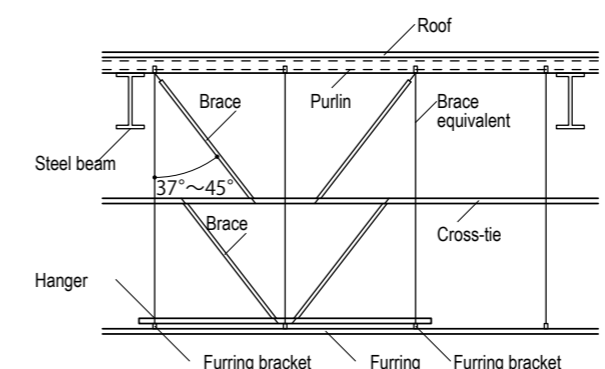

Figure 5. Strengthening of furring (H is more than 1,500 mm)<sup>2)</sup>

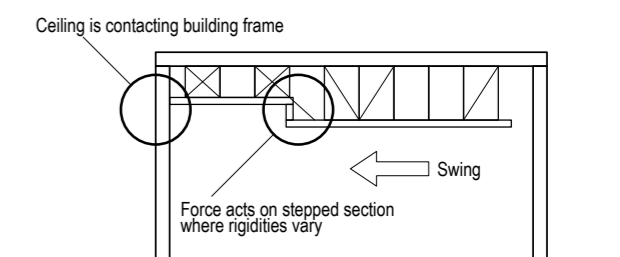

Figure 6. Sections prone to damage (source: Building Guidance Division, Housing Bureau, MLIT, No. 2402)

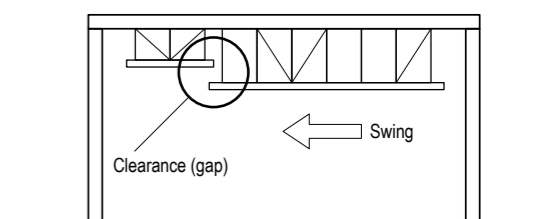

Figure 7. Ensure clearance at stepped section (source: Building Guidance Division, Housing Bureau, MLIT, No. 2402)

## 8-6 Earthquake-resistant design of interior walls and interior finishes

Interior walls and interior finishes have no direct relation to the collapse of buildings because they are not structural building elements which support a building. However, they play an important role in a real-life situation. Moreover, if interior walls and interior finishes break or deform, they can prevent escape and are a potential hazard. Prevention and reduction of damage should be considered in design.

### Gap in perspective between designers and residents

From the perspective of designing the building structure, damage to nonbearing walls is the result of releasing the strain energy applied to the building, which is assumed from the stage of design. However, from the perspective of residents, it is difficult to distinguish between bearing walls and nonbearing walls, and cracks in walls, etc. can become anxious issues. In addition, during an earthquake, the deformation of walls has prevented doors from swinging, and residents have been crushed to death by furniture (Figure 1 and Figure 2). Therefore, designers should recognize that damage to interior walls and interior finishes can have a major and even fatal impact on the lives of residents. It is also important to explain to clients just what is likely to happen at the time of a great earthquake.

### Importance of safe evacuation

Although the structural design of a building is ultimately based on the simple tenet that “the building should not collapse,” it is essential at the time of any disaster to secure safe evacuation. The deformation of walls or columns sometimes block the swing of doors and can be an obstacle to evacuation. In recent years, in response to such damage, manufacturers have developed a range of effective countermeasures to improve earthquake resistance, such as front doors with sufficient clearance between the door and frame, as well as seismic hinges, etc. (Figure 3). Overturning of furniture should be prevented by means of fixing to walls, and so on. Shop furniture and fixtures for displaying goods often lack adequate provision to prevent their overturning at the time of an earthquake. Attention needs to be paid to these points especially in the case of large-scale stores because such situations can cause death or injury.

### Design should assume deformation of buildings

The quaking of a building during an earthquake is basically temporary deformation of the building. The degree of the deformation varies greatly between RC structures (reinforced concrete structure), steel structures, and wooden structures. The story deformation angle at the time of an earthquake is about 1/500 to 1/2,000 in RC construction, about 1/200 in steel structures, and about 1/120 in wooden structures. Therefore, finishing materials and construction methods should be carefully selected for each structure by assuming a reasonable amount of deformation. Exterior walls of ALC panels, which are popular in steel structures, are best designed with a rocking construction that allows each panel to move out of alignment at the time of an earthquake. Setting joints that can absorb the movement of panels, should also be considered to prevent finishing tiles on the panels being damaged and falling off, as seen in past earthquakes. Regarding wooden structures, mortar finishes on the metal lathing of exterior walls have

often fallen off; although this does not affect the structure of a building, attention should be paid because it can endanger human lives. When stone is used for interior walls, it is often adhered to a backing. However, when stone is used at such high places as a wellhole, construction methods that prevent falling, such as fixing by metal fittings, should be adopted.

### Difference depending on the backings of partition walls

Partition walls are usually made by the screw fastening of boards to backings of wooden or light gauge steel studs. Finishes vary and include paint, cloth, etc. In the case of wooden houses, wooden studs for backing are fixed to wooden sills or beams, and deform with the building frame during an earthquake. Therefore, cracks are produced at the joints of boards. Actually, most houses hit by an earthquake suffer breaks of cloth at the joints of boards. On the other hand, in the case of RC and steel structures light gauge steel studs are usually used for backing to which boards are fastened, and both ends of the studs are inserted into the members called runners and fixed (Figure 4). Although the cracks that may be produced at the joints of boards are no problem in terms of structure, clients need to be reassured during the design phase about this effect.

(Tsunehide Takagi)

□ Source of figures

1) Joint research by the Building Research Institute and National Institute for Land and Infrastructure Management, Summary of the field survey and research on the 2011 Off the Pacific coast of Tohoku earthquake (the Great East Japan Earthquake), 2011



Figure 1. Damage to a front door (the Great East Japan Earthquake, 2011)<sup>1)</sup>

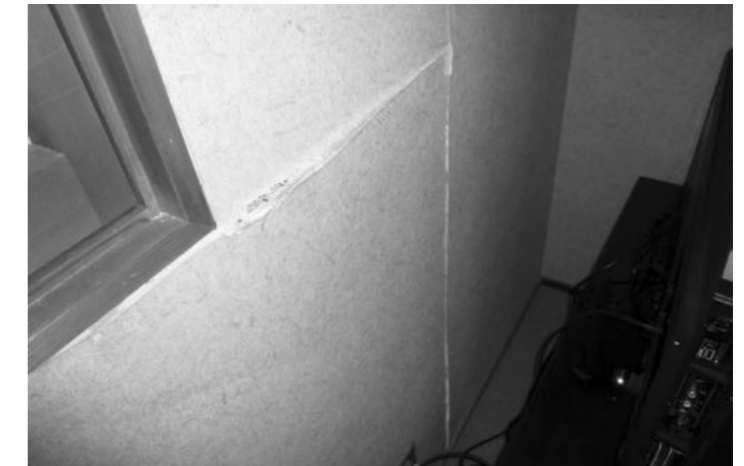

Figure 2. Break of wall cloth (the Great East Japan Earthquake, 2011)

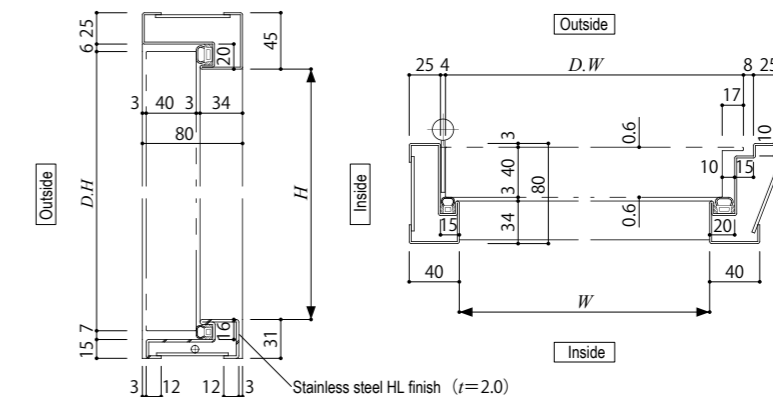

Figure 3. A front door with earthquake-resistant specifications (Fuji Metal) By ensuring sufficient clearance between the door and frame, the door is not prevented from swinging by deformation of the frame.

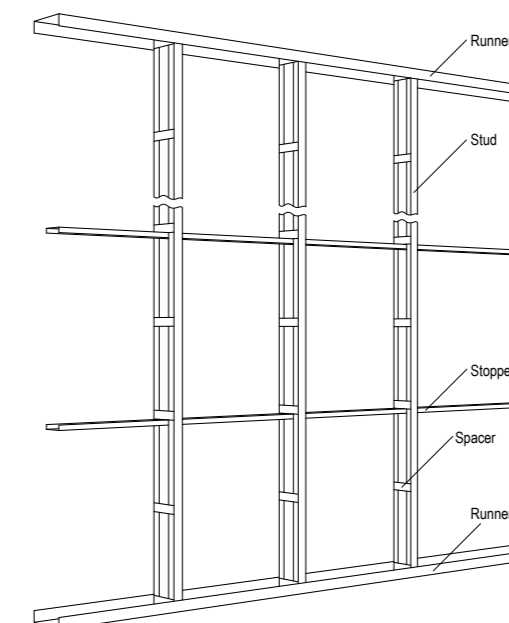

Figure 4. Light gauge steel furring for wall (source: JISA 6517)

## 8-7 Fixing and layout of furniture and fixtures

During an earthquake, preventing the overturning and falling of furniture and fixtures is important to prevent injury or death. After an earthquake, buildings serving important functions, such as hospitals, computer centers, and government offices, need to have maintained their ability to function, and part of this involves preventing the overturning and falling of furniture and fixtures.

### Effects caused by damage to furniture and fixtures

Injuries at the time of an earthquake are mostly caused by overturned furniture and fallen objects. (1) Prevention of overturning and falling of furniture and fixtures is important in terms of not only preventing the damage of furniture and stored objects but also reducing human injuries. In addition, the overturning of furniture or scattering of stored objects across an evacuation route may prevent or delay evacuation after an earthquake. Moreover, the overturning of furniture or scattering of stored objects may make maintaining business and everyday life after an earthquake difficult. In buildings that have to serve important functions after an earthquake, such as hospitals, computer centers, and government offices, attention should especially be paid to countermeasures against damage to furniture and fixtures.

### Overturning of furniture and fixtures

Based on reference (2), Figure 1 shows critical overturning accelerations for typical items of furniture. The critical overturning acceleration varies depending on the dimensions of the furniture, and when the acceleration exceeds the line of Figure 1, the furniture is likely to overturn. In addition, the figure also shows the floor responses of different buildings. The floor response varies depending on the earthquake, and the figure shows just some examples. However, it indicates that the overturning of furniture is generally more probable on the upper stories rather than the lower stories of buildings, and that the overturning of furniture is less probable in base isolated buildings.

### Fixing of furniture and fixtures

The best way to prevent the overturning and movement of furniture is to have cupboards, wardrobes and the like built in to the structure of the building. However, in reality, furniture is usually brought in to the building by the occupants, and in preparation for such a case, wall furring should be strengthened to enable the fixing of furniture, and occupants should be informed which sections of walls can be used for fixing.

When furniture is fixed, it is important to confirm that the walls or floors to which furniture is fixed have adequate strength. The strength required for fixing furniture varies depending on the weight of the furniture. Therefore, including assumed stored objects, furniture should be fixed to walls or floors with sufficient strength. At the Great East Japan Earthquake, heavy furniture which had been fixed to partition walls installed after the ceiling work broke the wall and the ceiling and overturned (Figure 2), and library bookshelves whose tops were tied with insufficient strength overturned in a chain reaction (Figure 3). It should be noted that inadequate fixing may cause greater damage, than no fixing.

### Well-planned layouts

In reality, it is difficult to fix all furniture to walls or floors, so a well-planned layout of furniture may reduce damage.

#### 1. Arrangements that cause less overturning

When tall furniture is placed in the central part of a room, overturning will become less probable if they are placed back to back and fixed together. Also, the arrangement of partitions in a T-shape or U-shape will cause less overturning.

#### 2. Separation of living space and storage space

Separation of residential space and storage space may reduce human injury. An example would be to concentrate objects which are prone to overturn or movement such as refrigerators and copy machines in a place surrounded by partitions in an office.

#### 3. Layout of furniture taking into consideration any evacuation route

The overturning of furniture or scattering of objects across evacuation routes or around evacuation doors may prevent or hinder evacuation and rescue. Therefore, evacuation flow routes should be taken into consideration when the layout of furniture is planned (Figure 4).

#### 4. Avoid placing furniture by windows

In some damage examples, furniture placed by a window smashed the glass during the earthquake and glass shards fell to the ground. Especially in high-rise buildings, it is best to avoid placing tall or heavy furniture by windows.

### Points to note for high-rise buildings

In high-rise buildings, not only the overturning of tall furniture but also the movement of equipment on casters may become a problem (Figure 5). In the shaking table test used to simulate the upper floors of a super high-rise building, not only the overturning of unfixed tall furniture, but also the violent movement of copy machines was observed. (3) Because any heavy object such as a copy machine or piano is dangerous when it moves, it requires countermeasures against both overturning and movement.

High-rise buildings may suffer greater damage due to prolonged quaking. At the Great East Japan Earthquake, drawers of desks and shelves without any latching mechanism gradually slid open, until the furniture finally overturned due to displacement of the center of gravity. Furniture should be used with a latching mechanism, and even low tables and furniture should be fixed.

### Effectiveness of seismically isolated structures

It is reported that the damage caused by the overturning of furniture greatly decreases if a seismically isolated structure is adopted because the acceleration response decreases. Even when the adoption of a seismically isolated structure for the whole building is difficult, used appropriately, the modern day seismic isolation floors which provide partial isolation or seismic isolation tables to protect art objects are available and effective.

(Mika Kaneko)

#### References

- (1) Tokyo Fire Department, Handbook of Countermeasures to Prevent the Overturning and Falling of Furniture and Fixtures (Japanese), 2010
- (2) Architectural Institute of Japan, Recommendations for Aseismic Design and Construction of Nonstructural Elements, 2003
- (3) Nagae et al., Super high-rise building experiments using E-Defense (Japanese), Web site of Hyogo Earthquake Engineering Research Center, National Research Institute for Earth Science and Disaster Prevention

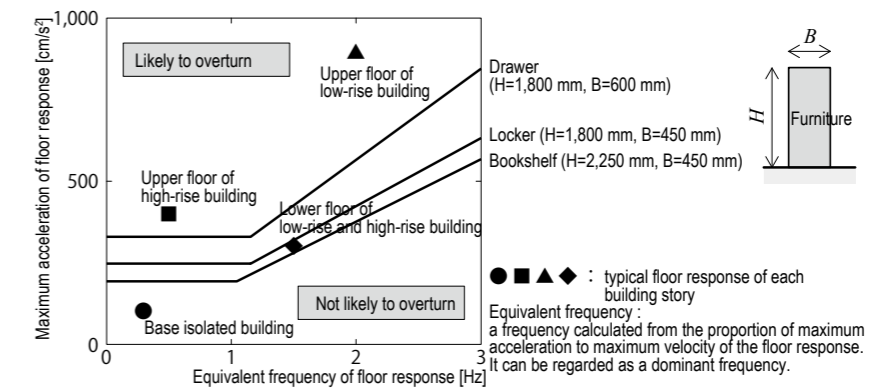

Figure 1. Critical overturning acceleration of furniture (when the acceleration exceeds the line, the furniture is likely to overturn)

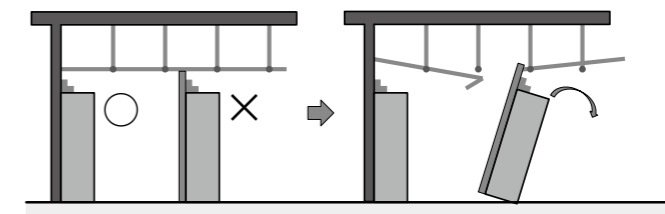

Figure 2. Heavy furniture fixed to a partition wall which was installed after the ceiling work may damage the wall and the ceiling and overturn during an earthquake.

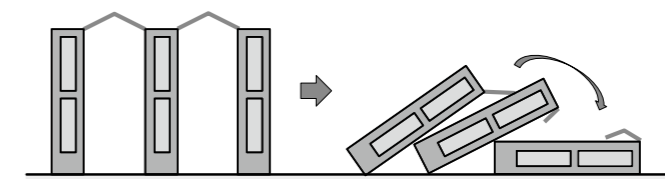

Figure 3. Library bookshelves whose tops are insufficiently tied may overturn in a chain reaction during an earthquake.

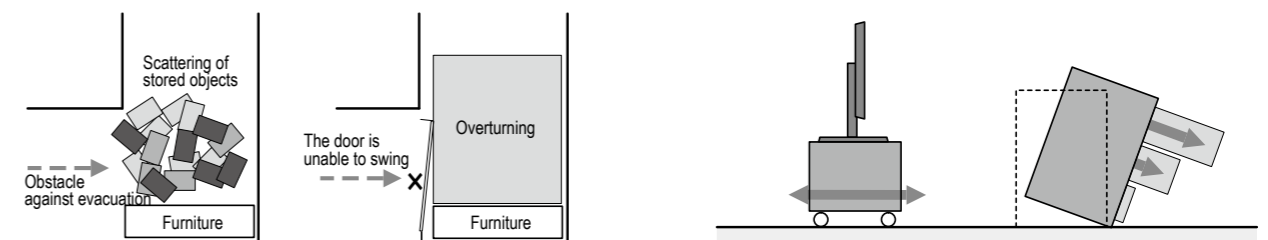

Figure 4. Overturned furniture or scattered fallen objects lying in evacuation routes or around evacuation doors may prevent or hinder evacuation and rescue.

Figure 5. Regarding high-rise buildings, attention should be paid to the movement of equipment on casters as well as the overturning of furniture due to the sliding of drawers.

## 9-1 Points of earthquake-resistant design of equipment

The basic purpose of earthquake countermeasures for building equipment is to prevent human injury or death, and the blocking of evacuation routes by the building's equipment and piping during an earthquake. To achieve this, equipment and piping should be firmly fixed to building frames, as well as ensuring the appropriate absorbance of displacement produced in building frames, non-structural elements, and equipment and piping.

### Guidelines on earthquake resistance of building equipment and required security of performance

Guidelines on the earthquake resistance of building equipment, the "Guidelines on Earthquake-resistant Design and Construction of Building Equipment, 2005 Edition" (Center Guidelines, hereafter) have been published by the Building Center of Japan.

More recently, in tandem with greater demands concerning the security of building functions after an earthquake, demands on the non-structural elements and building equipment have been increasing. Security of the equipment functions requires not only the strengthening of earthquake-resisting supports of individual equipment and piping but also countermeasures in terms of systems, including duplexing and preparing back-up equipment.

### Earthquake-resistant support of building equipment

Table 1 shows the design seismic coefficients indicated in the Center Guidelines; the coefficients indicate the seismic force that acts on equipment and is calculated by the local seismic coefficient method. This table is applied to ordinary buildings with a height of 60 m or less. The values in the table were determined by setting the strength coefficient for building use of equipment instruments and buildings (1.0 to 1.5) as 1.0 for normal grade (earthquake resistant class B), and the standard seismic coefficient without response analysis by structural calculation as 0.4, as well as by considering other coefficients. The design seismic coefficient for "basement and the first (ground) story," which is the base of the other coefficients, is set as 0.4, and that of "medium stories" and "upper stories, roof and penthouse" are set as 1.5 times respectively, that is, 0.6 and 1.0. Furthermore, earthquake resistant class A and S were added after the Great Hanshin-Awaji Earthquake with increasing strength coefficients for building use for equipment and buildings, and the coefficients were set as 1.5 times respectively with a maximum of 2.0. Also, when water tanks are placed in the basement or on the first (ground) story, values in parenthesis should be used, and when the equipment is mounted on vibration isolator bases it is considered as resistant class A or S.

There is no prescription on the earthquake-resistant strength of equipment other than that of water tanks, and design seismic coefficients prescribed in the Center Guidelines are just prescriptions for installment.

### Connection of piping, etc. to building frames

The Center Guidelines also prescribe earthquake-resistant supports for piping, etc. Because the characteristics of piping, etc. are different from equipment, the necessary strength of earthquake-resistant support members is prescribed as 0.6

times the total weight of the section between earthquake-resistant support members for resistant class A and B, and as 1.0 times for resistant class S. Earthquake-resistant support members are used aiming at limiting displacement perpendicular to the pipe axis. However, piping, ducts, and electric wiring suspended by members whose average length is 30 cm or less are excluded.

### Shapes and study methods of concrete foundations that connect equipment, etc. to the building frame

Figure 1 shows the partially revised shapes and study methods of concrete foundations described in the Center Guidelines. Although concrete foundations should basically be connected to the building frame, in the case of a roof floor, etc. that has a waterproofing membrane, how to treat the waterproofing membrane becomes an issue. Whether the foundation's strength against the seismic force that acts on any section of foundation where equipment or piping is set is enough, needs to be evaluated.

Among the shapes of foundations shown in the figure, the foundations of type-d and type-e are integrated with the building frame. In these cases, the facility designer should indicate the dimensions, weight, position of center of gravity, etc. of the equipment to the structural engineer, who should design a foundation, and the foundation should be constructed in the architectural work. The foundations of type-a, type-b, and type-c are set on a protective concrete layer. In these cases, it is allowed that the facility designer indicates the layout of equipment, weight and position of center of gravity of the instrument, and foundations, etc. to the structural engineer and gets confirmation, and the foundation is constructed in equipment work. The application imposes various restrictions because the foundation is not integrated with the building frame.

### Absorption of displacements

The Center Guidelines indicate a need for the absorption of displacement that is produced in buildings as well as the connections between equipment and piping, etc. As typical building elements that are subject to displacement, "expansion joints" for absorption of the displacement of the building frame itself, "inlet sections of buildings," "inter-story," and "ceiling and upper floor slabs" as non-structural elements are all included. In building equipment, displacement occurs at connections between equipment fitted with a vibration isolator and connecting piping, and between main piping and branch piping. Piping, etc. which traverses or connects these building elements is required to absorb any displacement in tri-axial directions.

The basic pipe joint to absorb displacement is the "displacement-absorptive pipe joint," which displaces in the direction perpendicular to the pipe axis but is not displaced in the direction of the axis. When an element made of brittle material, such as a water tank is horizontally displaced by seismic force, the connecting piping may also be displaced in the vertical direction depending on the piping layout. In such cases, if the internal pressure of the connecting piping is very low, then "flexible pipe joints" which can absorb displacement both in the direction of the axis and in the direction perpendicular to the axis may be used.

(Masahiro Hirayama)

□Source of figures

1) Kenchiku setsubi taishin sekkei seko shishin (The Guidelines on Earthquake-resistant Design and Construction of Building Equipment), 2005 Edition, The Building Center of Japan

	Earthquake resistant class of building equipment			Divisions of applied story
	Earthquake resistant class S	Earthquake resistant class A	Earthquake resistant class B	
Upper stories, roof, and penthouse	2.0	1.5	1.0	
Medium stories	1.5	1.0	0.6	
Basement and the first story (ground level)	1.0 (1.5)	0.6 (1.0)	0.4 (0.6)	

When water tanks are located in the basement or the first story (ground level), values in parenthesis should be used.

Table 1. Summary of horizontal design seismic coefficients of building equipment by the local seismic coefficient method<sup>1)</sup>

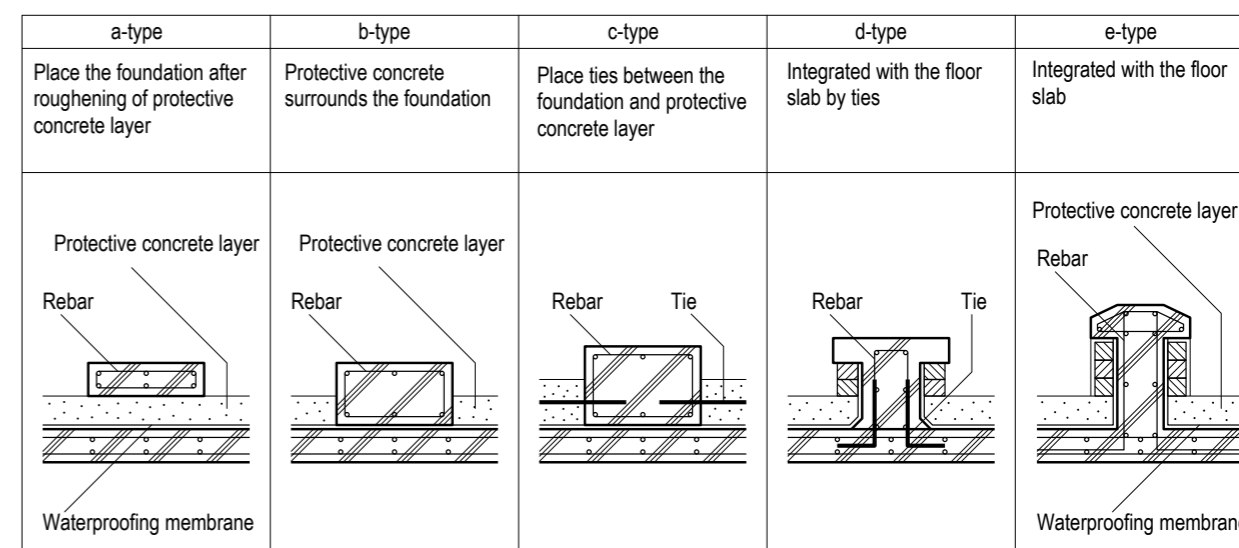

Figure 1. Shapes and study methods of foundation (based on reference 1))

## 9-2 Earthquake damage examples and building elements and equipment prone to damage

Factors that cause building equipment damage include the “seismic coefficient” and “displacement (correlation).” Damage due to “the degree of seismic force” would not be very much if design and construction follow the “horizontal design seismic coefficient” and “shape of foundations” shown in the previous section. However, “displacement” is produced in various states, and therefore appropriately considered measures should be taken in design and construction so that damage will not occur.

### Degree of seismic force and countermeasures

Examples of the damaged sections of equipment connected with anchor bolts to concrete foundations, as shown in Figures 1 and 2, include the main body, base members at the bottom, and supporting members at the top or side of the equipment.

With regards to water tanks, earthquake-resistant specifications are defined, and those products that meet the specifications are labeled as “Earthquake-resistant 1G,” etc. However, much damage was observed at the top plates of water tanks with manholes even though they had met earthquake-resistant specifications.

Recently distinct damage examples as shown in Figures 3, 4 and 5, include deformation of base members or breaks of anchor bolts of floor-type equipment, that had been connected to concrete foundations, as well as deformation of not only main bodies, but also vibration isolator bases. In cases of ceiling-type equipment, a lot of supporting members at the top or side of equipment were damaged. Much of this damage can be avoided if base members and supporting members are adequately strengthened. However, on the design and construction side, the selection of equipment and method of installation should also be studied in consideration of the earthquake-resistant strength of the equipment.

In the earthquake-resistant design of equipment, concrete foundations are as important as anchor bolts as a member which connects the building frame and the equipment. Compared with ordinary self-weight supporting foundations for vertical support, earthquake-resistant foundations require strength against horizontal force, and therefore, the specifications include various conditions.

When a foundation is put on the roof, there is a limitation. A mat foundation, which has a large contact area with protective concrete, can be used when the seismic coefficient of the equipment is 1 or less (earthquake-resistant class B) unless uplift of the foundation does not occur. However, a beam-shape foundation which has less contact area with protective concrete, as seen in Figure 6, must not be uplifted and its anchor bolts not subjected to any pulling force. Furthermore, a footing which has even less contact area with protective concrete cannot be used even when the equipment is classified as earthquake-resistant class B.

For planning the shape of foundations, a decision should be made based on dimensions of the equipment and gross weight including the equipment and foundation compared with the allowable live load in terms of structural design. When the gross weight exceeds the allowable live load, considerations on foundation lightening including partial use of beam-shape foundations should also be made. Attention

should be paid not to put a foundation on a roof by mistake in extra work, etc., which is often the case.

Regarding anchor bolts for equipment, L-shape or LA-shape should not be used because their embedding depths tend to be shallow.

### Damage due to displacement and countermeasures

Piping which passes through the inlet section of a building (Figure 7) is subject to tri-axial deformations, those in vertical and X-Y directions, due to displacement of the building and the ground, and the displacement sometimes become great. In such cases, three or four cushion elbows or a displacement-absorptive pipe joint is generally used in order to absorb the displacement of the piping. Further, as a method to reduce damage to piping, a pit (with a base, as appropriate) independent of the building is sometime used to decrease the displacement of piping.

Piping which passes through expansion joint sections is also subject to tri-axial deformations, and therefore, each set of piping should be cranked and two of three flexible displacement-absorptive pipe joints should be installed. However, this arrangement requires a considerable space and is often difficult to achieve. Therefore, the piping at the expansion joint is often attached to one displacement-absorptive pipe joint in the direction of the pipe axis, as shown in Figure 8. However, such arrangements are likely to cause damage because displacement in the direction of the pipe axis cannot be followed. So, basically piping should not be passed through expansion joint sections. If it is inevitable, then fundamentally it should be limited to the first (ground) story where the displacement is small.

Measures to deal with displacement produced within equipment such as equipment and connecting piping sometimes become an issue (Figure 9). High-performance vibration isolators which minimize vibration from equipment are sometimes used in order to ensure comfort at ordinary times. However, a high-performance vibration isolator is prone to decrease earthquake resistance because it produces relatively great displacement. Figure 10 shows an example of damage by a high-performance vibration isolator. Comfort and earthquake resistance often have conflicting characteristics, and therefore attention should be paid to achieving selection, design and construction of the best suited vibration isolator.

In summary, regarding the methods for absorbing displacement, flexible pipe joints are used for a water tank made of brittle material and which is subject to low internal pressure at the connecting piping; displacement-absorptive pipe joints are used for the connecting piping of equipment with vibration isolators that can produce considerable displacement; and in addition, canvas connections are used for connecting fan ducts. Rigid fixation, that is, earthquake-resistant support is required at each end of displacement-absorptive pipe joints or canvas connections which absorb displacement, and careful attention should be given to selecting their positions.

(Masahiro Hirayama)



Figure 1. Anchor bolts came off



Figure 2. Damage of the corners of the concrete foundation

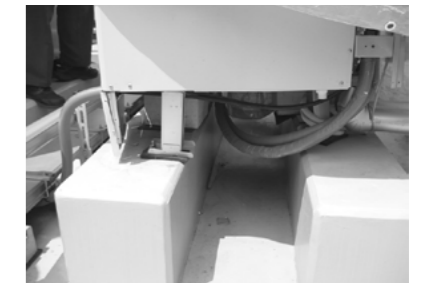

Figure 3. Deformation of the equipment's leg section



Figure 4. Fracture of base member of the equipment at the connection to the anchor bolts



Figure 5. Deformation of vibration isolation base due to deformation of the equipment base member



Figure 6. Overturning of beam-shape concrete foundation



Figure 7. Piping passing through inlet portion of the building

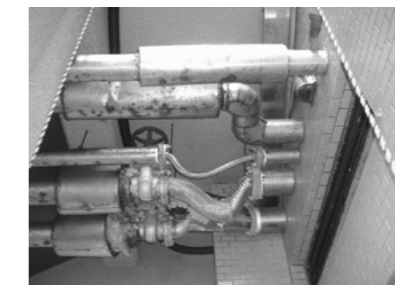

Figure 8. Piping passing through expansion joint

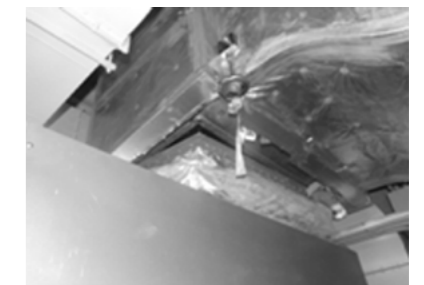

Figure 9. Fracture of canvas duct connection from the air conditioner



Figure 10. Deformation of the stopper due to misalignment of the vibration isolator

### 9-3 Securing equipment functions after an earthquake

Although the basis of earthquake-resistant measures concerning building equipment is the prevention of injury or death, there are many building functions which require the continued running of secure equipment after an earthquake. The importance, functions, and periods of securing, etc. of equipment functions vary depending on uses, roles, installation requirements, etc.

#### Ensuring consistency between the importance of a building and the earthquake resistance performances of equipment

The importance level of earthquake resistance performance varies depending on the building purpose (Section 5-3). It is better to give some allowance to the earthquake resistance performance of building frames and to ensure the equivalent performance of non-structural elements and equipment. The table in the Center Guidelines which indicates design standard seismic coefficients (KS) for building equipment (Table 1 in Section 9-1) classifies into earthquake resistant class B, A, and S depending on the strength coefficients for the purpose of buildings and equipment. Generally, the importance level of equipment of those buildings that should resist great earthquakes and secure equipment performance after the earthquake should be regarded as high, and the seismic bearing strength should be that required for an earthquake resistant class S or A. The earthquake resistance of the equipment system needs to be thoroughly discussed with the client based on the equipment's importance level. For example, public facilities that will function as a base for restoration after a disaster, and facilities that accommodate numbers of incapacitated or frail people such as medical facilities, homes for the elderly, and welfare facilities are required to ensure equipment functions necessary for their use for some significant period after the earthquake.

#### Equipment systems with a high level of importance

Immediately after a great earthquake, damage to all utilities including power blackouts, water outages, drainage failures, shutoffs of city gas, interruptions of communication, and severe traffic jams are assumed to occur, in addition to possible fires. For those buildings which should secure equipment functions after the earthquake, it is required to assess beforehand the likely situation after the earthquake, in terms of building use, as well as what equipment functions should be secured. Generally, the most important equipment function to be secured at the time of a utilities failure is supplying electricity and water. Supplying minimal lighting, communication functions for information collection, drinkable water for life-support and general service water is an essential equipment function to maintain daily life in the building. Moreover, medical facilities equipped with state-of-the-art medical equipment definitely require the securing of an electric power supply and the supply of adjunctive equipment functions. Even after a great earthquake, these facilities are required to provide about the same level of equipment functions as for normal everyday use.

When considering the Hyogoken-Nanbu Earthquake and 2005 Miyagi Earthquake, the number of days needed to restore utilities damaged by a great earthquake is about 2 days

for communication, 3 days for electricity, about 30 days for water supply, and about 45 days for city gas. However, in the case of Tokyo, etc., it is assumed that extra days will be needed. To secure an electric power supply, an in-house power generating station and fuel are required. To secure drinkable water, bottled water as well as the water remaining in elevated water tanks and reservoirs are required. And to secure general service water, wells, etc. are required. It is essential for those facilities with a high level of importance and that are required to maintain various equipment functions to continuously ensure systems are in place to ensure the required equipment functions.

#### Securing electric power supply

The basis for securing an electric power supply is an in-house power generating station. In principle, a generator should be an air-cooled type which does not need any cooling water. The amount of oil to be stored is determined by the required number of days for securing equipment functions. When securing functions for more than one day is required, though depending on the amount to be stored, the facility is likely to be designated "a hazardous materials handling facility," and countermeasures are required. In the case of a facility, such as a hospital, that requires a continuous electric power supply after an earthquake, it is necessary to consult with the local government on a routine basis and prepare a system that enables the preferential procurement of oil. State-of-the-art medical equipment require an electric power supply with great capacity, and tends to take considerable time to start up when the electric power is stopped. It is important to have sufficient discussion within the facility on a routine basis concerning the use of medical equipment after an earthquake.

#### Securing water

Basically, bottled water should be used for drinkable water, and water remaining in reservoirs, etc. is used for general service water. However, for medical facilities, etc. which require a continuous supply of water, a well should be established in principle. It is important to note that immediately after an earthquake tap water will not be fit to drink after the water pressure has dropped. To deliver water through water pipes, it is better to locate a reservoir in the basement. Even if the water pressure of water pipes drops during the day, it is likely that water can be delivered more effectively at night when the amount of water used decreases.

#### Equipment system that can secure equipment functions

Building equipment basically functions through its "piping/wiring" connections and therefore is more fragile and prone to damage in terms of ensuring functions compared with damage to building elements. Naturally, individual equipment and devices should be set in an earthquake-resistant manner. In addition, to ensure important equipment functions, duplication with different systems should be basically adopted. The different systems need to be of different system configurations and piping/wiring routes, such as the combination of central air-conditioning and air-cooled packaged air-conditioners as an air-conditioning system. Moreover, they need to be set in different places that are subject to less acceleration to improve the quality of duplication.

#### Points to note on a system ceiling that is prone to damage

Earthquake-resistant system ceilings which have recently been developed are strengthened by using a variety of different shaped steel for anti-rolling. Lightweight lighting fixtures and small devices are rigidly connected to ceiling frames in earthquake-resistant design and construction. However, small panels such as equipment panels are prone to moving and falling through quaking, though ceiling panels with standard dimensions, including grid-shaped and line-shaped panels, are relatively resistant to quakes. Small equipment panels which result from installing lighting fixtures and air diffusers have small dimensions, and therefore, are hard to be firmly fixed. Equipment panels also should have dimensions as close as possible to the standards.

In recent years, indoor suspended units of small size individual air-conditioning systems have often been adopted. According to the Center Guidelines, lightweight equipment with a load of 1 kN or less may be securely installed following the method specified by the manufacturer. However, practically no manufacturer specifies the method of installing such lightweight equipment, and designers and builders often install such equipment without anti-rolling measures making an unclear distinction between lightweight equipment and those with a load of 1 kN or more. When indoor suspended units or main ducts roll within the ceiling, flexible ducts connected to air diffusers displace in tri-axial directions, and air diffusers become subject to seismic force in tri-axial directions. Air diffusers installed in the system ceiling are prone to come off when they are fixed using the counterforce of spring members or when attached by crank type fixed panels. Therefore, they should be fixed to ceiling frame members with fasteners. Naturally, falling prevention wire from upper slabs also should be used.

Although displacement-absorptive pipes such as SUS flexible pipes and resin pipes and unwinding piping have been used for sprinkler heads in recent years, the unexpected sprinkling of water still occurs occasionally; many such incidents were caused by blocking of the flexible unwinding piping by hang bolts, air-conditioners, ducts, piping, etc. To prevent such occurrences, adequate distances between unwinding pipes and other objects should be ensured, and a distance of approx. 20 cm should be ensured for important rooms. Moreover, sprinkler heads should be fixed to ceiling frame members with fasteners instead of spring members.

A variety of methods to fix lighting fixtures to system ceiling frames have been adopted by manufacturers of lighting fixtures. Many of the methods have adopted fastening to ceiling frames with crank type fasteners. Moreover, falling prevention wires from upper slabs have also been adopted.

*(Masahiro Hirayama)*

## 9-4 Points of equipment planning for seismically isolated buildings

The seismically isolated layer of a building requires the coordination of equipment planning and architectural planning because equipment piping, etc. is located in this section. Understanding the mechanism of base isolation joints and planning that is free from any problems with building and equipment functions is necessary. In addition, a seismically isolated layer sometimes requires a cool/heat pit application or ventilation. Including the above points, seismically isolated buildings and equipment planning are discussed in this section.

### Carrying in and out of equipment and seismic isolators

As Figure 1 shows, the space within a seismically isolated layer is used for installing piping or deploying the carrying routes of equipment such as cable racks. In addition, elevator pits or reservoirs are sometimes located in this area. Therefore, not only setting the positions of machine hatches for the carrying in and out of seismic isolators, but also the routes for carrying them in and out have to be ensured in the space within a seismically isolated layer. In such cases, as Figure 2 shows, the plan should be made so that the carrying routes have no obstacles such as piping crossing the routes. This requires not only equipment planning, but also coordinating with the plan design of the upper floor.

Although the lifetime of seismic isolators is defined as 60 years, the same as building frames, they should be planned assuming replacement due to deterioration or earthquake damage. Various types of devices for carrying seismic isolators in and out have been developed for seismic isolation renovations (retrofit), one example of which is shown in Figure 3.

### Handling of mid-story isolation

In the case of mid-story isolation, piping, etc. should be connected with seismic isolation joints to absorb the relative displacement produced between upper and lower stories. When heat source machine rooms and/or electric rooms are located under the isolated layer, supply systems diverge. In such cases, a greater number of vertical pipes and cables used compared with base isolation, and therefore, the needed quantity of seismic isolation joints increases. In addition, it becomes difficult to ensure adequate clearance for the absorption of relative displacement. Moreover, although it is technically possible to make seismic isolation joints for chimneys in the case where heat source machine rooms are placed under the isolated layer, there are many issues including maintaining heat resistance and air tightness as well as following deformation.

### Types of seismic isolation joints

The types of seismic isolation joints used for piping in base isolated buildings are mostly made of rubber or stainless steel. As Table 1 shows, they are also classified into horizontal type, vertical type, spring type, and roller type by setting form. The material is selected according to fluid and equipment functions. The setting type is determined considering the relative displacement (seismic isolation amount), weight of pipes (pipe size), and cost. Seismic isolation joints for a relative displacement (in the horizontal direction) of 300 to 800 mm and for a pipe size of 20A to 300A are available. Regarding installation,

connecting points between the base isolated building side and the ground side (the earth side) should first be defined. Then, the range of the joint's movement should be ensured. For example, if the maximum horizontal displacement is 600 mm, a range of 1,200 mm in diameter should be ensured. In addition, the building should be kept an adequate distance away from its surroundings in order to avoid blocking of the displacement (movement). As Figure 4 shows, the displacements of seismic isolation joints can be verified by simulations. Moreover, as seen in Figure 5, the following of displacements can be verified by vibration tests assuming a great earthquake.

By ensuring surplus length, electric cables more easily absorb displacement than piping as Figure 6 shows.

### Thermal environment and ventilation of the story above a seismically isolated layer

A seismically isolated layer is exposed to outdoor air, and therefore it should be assumed that heat transfer and heat loss similar to that of exterior walls occur at the floor slab above the isolated layer. That is, when a habitable room is above a seismically isolated layer, its slab should be insulated. Floor heating in winter may be required depending on room use.

Recently, as Figure 7 shows, a seismically isolated layer is often made as a cool/heat pit and reduce the fresh air load by utilizing earth thermal capacity. This mechanism is especially effective for a building with a great building area, such as an auditorium or an assembly hall, because it has a large area of seismically isolated layer, that is, a great contact area to the ground. In such cases, attention should be paid not only to heat insulation but also to waterproofing and preventing the entry of trash and dirt in order to prevent the occurrences of malodors over time. On the other hand, a seismically isolated layer with a large area which does not utilize earth thermal capacity sometimes requires ventilation equipment. In such cases, the required air volume of ventilation becomes considerably great even when the ventilation frequency is once per hour because the area is so large. Therefore, some form of device is required, such as maintaining the direction of ventilating air by jet fan, etc.

(Wataru Kuroda)

#### □ Sources of figures

- 1) Japan Construction Mechanization Association, Kensetsu no seko kikaku (Execution Planning of Construction), November, 2008
- 2) Kokyo kenchiku setsubi koji hyojunzu: Denki setsubi koji hen (Standard Drawings for Equipment Works of Public Buildings: Electric Equipment Works), 2010
- 3) Takashi Yanai, Kuki chowa eisei kogaku binran 5: keikaku seko iji kanri hen (Manual of Heating, Air-Conditioning and Sanitary Engineering-5: Design, Construction and Maintenance, Ver. 14, the Society of Heating, Air-Conditioning and Sanitary Engineers of Japan, 2010)

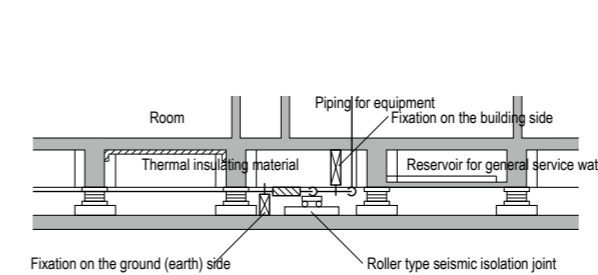

Figure 1. Piping for equipment within a seismically isolated layer

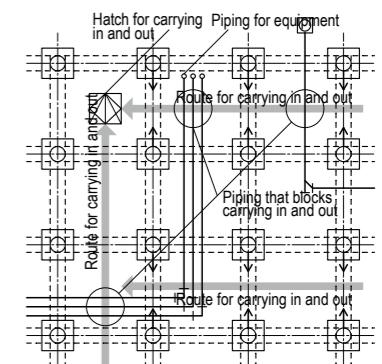

Figure 2. An example of a plan within a seismically isolated layer

	Horizontal type	Vertical type	Spring type	Roller type
Type of seismic isolation joint				
Material and use	Rubber: sewage, rainwater, ventilation	Rubber: water, cold water, cooling water, sewage, rainwater, ventilation SUS: water, cold water, cooling water, fire extinction	Rubber: water, cold water, cooling water, sewage, rainwater, ventilation SUS/Teflon: water, cooling water, sewage, rainwater, ventilation, fire extinction, oil, steam	Rubber: water, cold water, cooling water, sewage, rainwater, ventilation SUS/Teflon: water, cooling water, sewage, rainwater, ventilation, fire extinction, oil, steam

Table 1. Types of seismic isolation joint (source: TOZEN Corporation)

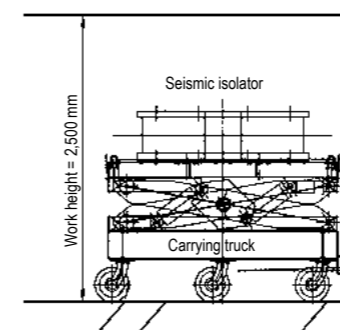

Figure 3. An example of a truck for carrying a seismic isolator<sup>1)</sup>

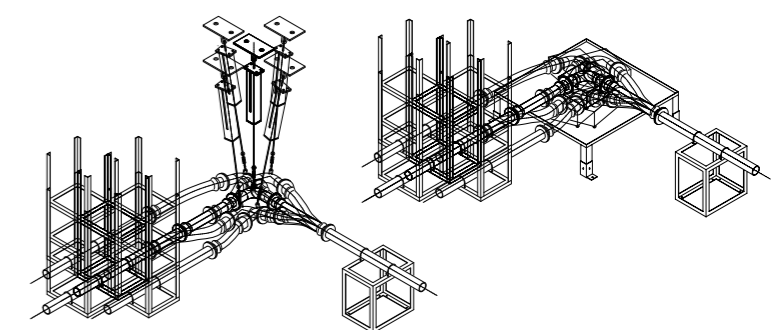

Figure 4. An example of a simulation of a seismic isolator joint's deformation (source: TOZEN Corporation)

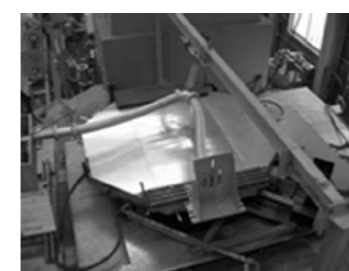

Figure 5. A vibration test of a seismic isolation joint (source: TOZEN Corporation)

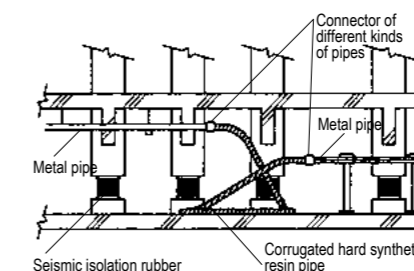

Figure 6. An example of seismic isolation of electric cables<sup>2)</sup>

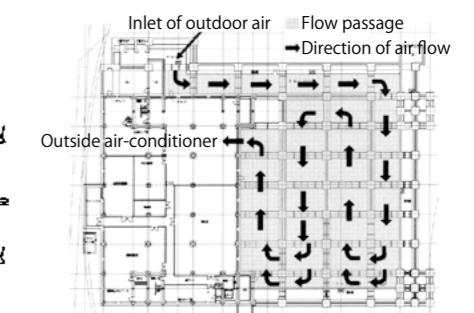

Figure 7. An example of a cool/heat pit<sup>3)</sup>



## 9-5 Seismic countermeasures for elevators (1)

Seismic countermeasures for elevators have evolved practically through the experience of great earthquakes. The goals of seismic countermeasures are prevention of being trapped in an emergency, the ability to rescue passengers, and prevention of any shutdown caused by tangled cables. To achieve these, verification of the earthquake resistant class and emergency operation items are required. Long-period countermeasures are essential for high-rise elevators.

Nearly 100 years have passed since the establishment of the popular elevator system with a cage and a counterweight connected with a steel cable driven by a winding machine. Walking up and down more than 5 or 6 flights of stories on a daily basis is virtually unthinkable. Development of the elevator for the first time made it possible to construct high-rise buildings with more than 5 or 6 stories. In this sense, it can be said that the elevator is the mastermind behind modern high-rise architecture. Presently, as many as about 700,000 elevators across the country and 150,000 elevators in the Tokyo area are supporting the functions of mid- to high-rise buildings as well as super high-rise buildings.

### Seismic countermeasures for elevators have advanced in parallel with earthquake resistance standards for buildings

In 1968, the construction of the Kasumigaseki Building was completed, and the era of super high-rise buildings commenced. Since then, as earthquake resistance standards for structures have been revised with experience gained from every great earthquake, seismic countermeasures for elevators have also been revised. At the time of the 1995 Great Hanshin-Awaji Earthquake, it made a clear difference in terms of damage, whether an elevator had been installed before or after 1983. Measures against long-period vibration developed from study of the 2004 Chuetsu Earthquake were reflected in the guidelines after 2009 (Figure 1). However, at the time of the 2011 Great East Japan Earthquake, falling accidents involving escalators were observed and the guideline will be reviewed.

### Goals of seismic countermeasures for a building and its elevators should be consistent with each other

The goals of seismic countermeasures for a building are that even when a rare great seismic motion occurs the building does not suffer any damage at major sections of the building structural resistance, and that even when an extremely rare giant seismic motion occurs the building does not overturn or collapse. The goals of seismic countermeasures for elevators are consistent with these criteria. It should be operative even when a rare great seismic motion occurs. And when an extremely rare giant seismic motion occurs it should maintain the function to hold the cage and enable the passengers to be rescued. According to these goals, the earthquake resistance performance of elements and parts are prescribed.

Earthquake resistant classes have been established for elevators, too. Earthquake resistant class A09 is the standard for ordinary building equipment. In addition, regarding the operational limit strength of elevators after an earthquake,

there is earthquake resistant class S09 which has been defined with an increasing earthquake-resistant design seismic coefficient according to the scale and amount of use by the public. According to the scale and the requirement for early resumption of operation after an earthquake, class S09 has had its earthquake-resistant design seismic coefficient increased to the maximum of 1.5 times from that of A09. Countermeasures including increasing earthquake-resistant strength and preventing shut down caused by tangled cables are required for the class.

### Emergency operation items for elevators have been strengthened

Emergency operation systems intend to avoid passengers being trapped, secondary damage, etc. by controlling moving elevators. The adopted items vary depending on the height and use of a building (Table 1).

#### 1. Emergency operation against P-wave

The elevator detects preliminary tremors and stops at the nearest story to minimize the possibility of trapped passengers. This item is required on freight elevators, car elevators, passenger elevators with movement of more than 7 m, and bed elevators.

#### 2. Emergency operation against S-wave

The elevator moves or stops according to the horizontal acceleration of S-wave (principal motion) which arrives after the P-wave, and controls secondary damage that may hamper early restoration after the earthquake.

#### 3. Emergency operation against tangling of long objects

When a long-period seismic motion of a distant earthquake with difficult to detect P-waves occurs, the elevator avoids the possibility of any ropes or cables tangling with any projecting object within the hoistway by stopping at the nearest story by specific detection of S-waves in buildings with a height of 60 to 120 m, or in buildings with a height of 120 m or more, the elevator is controlled by long-period seismic motion sensors.

#### 4. Other emergency operation items

The items include installment of a standby power supply for emergency operation equipment, display of operation information, restart operation function, automatic diagnosis and temporary recovery operation. Every item is intended to reduce those cases that would require waiting for rescue by the limited number of maintenance engineers after the earthquake.

### Countermeasures against long-period seismic motions

At the time of the 2003 Tokachi-oki Earthquake, 2004 Chuetsu Earthquake, and 2011 Tohoku Earthquake, high-rise elevators in the Tokyo and Osaka areas, far from the focus, suffered damage due to long-period seismic motions. Earthquake accelerations were not very great at these areas and P-wave and S-wave sensors did not operate. However, cables, etc. swung greatly and tangled with projecting objects within the hoistway and suffered damage. The long objects resonated with slow and wide seismic motions. By setting the detection level of S-wave sensors lower, the elevator can detect motions with little acceleration but great quaking, that is, detect vibrations of the primary natural period of the building, and estimate swings of long objects such as cables. When the swinging is estimated to become large, the elevator stops

at the nearest story and shuts down to control the swinging of any long objects. Damage to elevators in super high-rise offices or condominiums would greatly affect the occupants. Even repairing just one of a few elevators would make waiting time during the repair period longer and affect the daily lives of residents. Especially at the time of the Great East Japan Earthquake, the number of stopped elevators increased due to power saving in response to the nuclear accident, which was again detrimental to daily life.

(Kazuo Adachi)

□ Source of figures  
1) Japan Elevator Association, Shokoki gijutsu kijun no kaisetsu (Interpretation of Technical Standards of Elevators), 2009

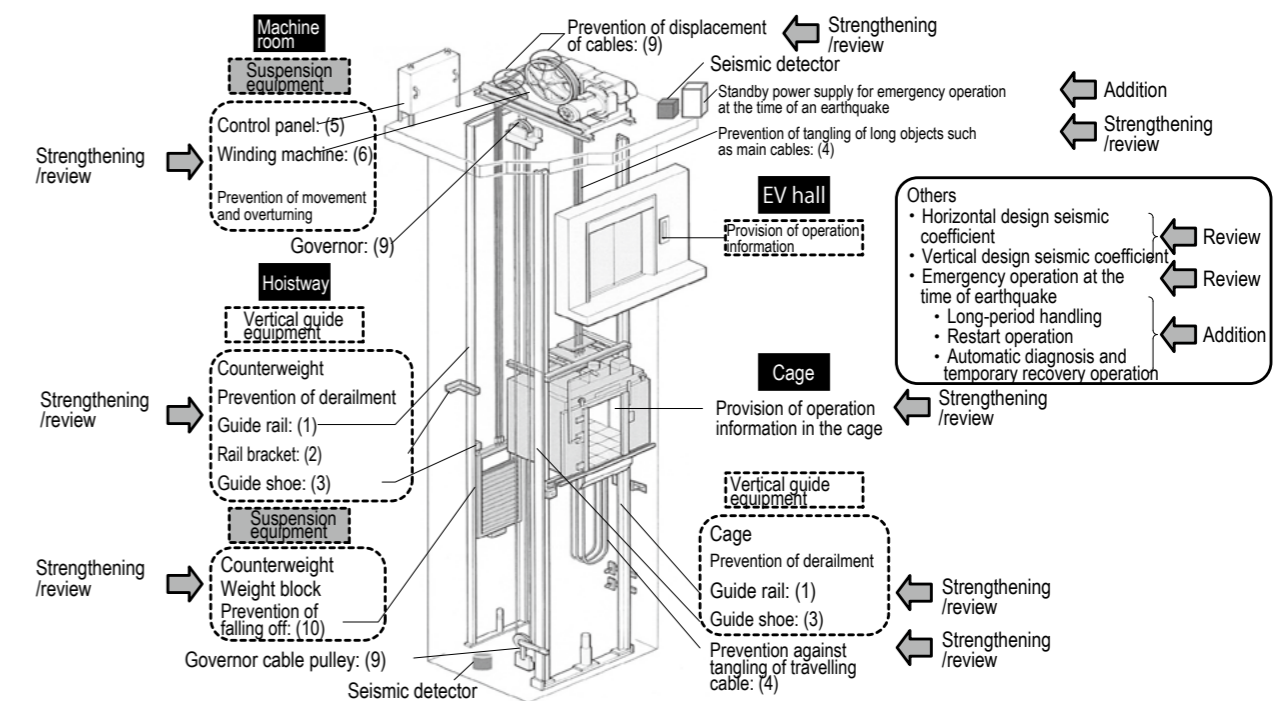

Figure 1. Guidelines for earthquake-resistant design and construction of elevators, Outline of the revision in 2009 (Elevators)<sup>31</sup>



Figure 2. Storage box for emergency installed in an elevator. They were installed after the Great East Japan Earthquake as a countermeasure against being confined.

Emergency operation items	Statutory obligation	Standard specifications in the guidelines	Optional specifications in the guidelines
1. Emergency operation against P-wave	○	○	
2. Emergency operation against S-wave	○	○	
3. Installment of standby power supply (support for emergency operation)	○	○	
4. Provision of operation information (display in the cage)	○	○	
5. Provision of operation information (provision of information in the cage)		○	
6. Emergency operation against swinging of long objects		○	
7. Provision of operation information (provision of information in the elevator hall)			○
8. Restart operation function at the time of confinement			○
9. Automatic diagnosis and temporary recovery operation			○

Table 1. Mandatory emergency operation items<sup>31</sup>

## 9-6 Seismic countermeasures for elevators (2)

The main goal of earthquake resistance for an escalator is that the main body does not fall off. Following the accidents at the time of the Great East Japan Earthquake, the earthquake resistance standards of escalators are being reviewed. Moreover, earthquake-proof conversion of existing elevators is as important as the seismic retrofit of buildings. The earthquake resistance of building frames surrounding elevators should also not be overlooked. With the advent of the aging society, ensuring the means for vertical movement is becoming increasingly important.

### The main goal of seismic countermeasures for escalators is that they do not fall down

Escalators provide the means of vertical movement between stories for many people. Escalators are often seen in those buildings used by large numbers of people, such as commercial, traffic, and public facilities. First of all, escalators should not cause death or injury at the time of an earthquake. Escalators must not trap passengers even when a rare great earthquake occurs, and therefore no seismic code in terms of operational performance is necessary. The main goal of seismic countermeasures for escalators is that when an extremely rare giant earthquake occurs they do not fall off from supporting members such as beams even though their equipment may suffer some damage.

At the time of an earthquake, the building frames of upper and lower stories move by relative story displacement. The design limit of relative story displacement for escalators is prescribed as 1/100. With this displacement of building frames, the supporting angle at one end of the escalator should be rigidly fixed to a supporting member such as a beam. The other end should not be fixed to a supporting member and an adequate overlap allowance ensured. Or, when the end of the escalator cannot be fixed to a supporting member, adequate overlap allowances should be ensured at both ends. When escalators have intermediate supporting parts in main body trusses, falling should also be prevented at these parts. The overlap allowances required at the supporting parts are calculated during the design. Sufficient strength of the supporting members and the pedestals should be secured. The rigid support side should be fixed in both longitudinal and lateral directions. On the other hand, the non-rigid support side should not be fixed in the longitudinal direction, but should be fixed in the lateral direction. At the time of the Great East Japan Earthquake, escalators fell off at commercial facilities. It is thought that some falls were caused by inadequate construction of supporting members. In the case of commercial facilities, the displacement of building frames was great because they are mostly built with steel structures with long spans. Fortunately no one was injured, but such incidents must not occur. Some commercial facilities install chains as a fail-safe measure to prevent any risk of falling after an earthquake. It is important to consider seismic countermeasures for escalators (Figure 1).

### Elevators in existing buildings often have inadequate seismic countermeasures

Just as the required earthquake resistance of building structures changed after the new standards for earthquake

resistant design in 1981, those for elevators also changed after the new technical standards released in 1983. Although further safety techniques have been developed since then, many existing elevators have not been renovated according to these newer standards. At the time of a seismic diagnosis of existing buildings, not only the building frames but also non-structural elements and equipment should be examined, and the seismic diagnosis of elevators is also essential. Periodic maintenance checks are required for elevators, and the inspection report enables seismic diagnosis by including a section noting whether earthquake countermeasures have been taken. At present, most elevators in those buildings built more than 30 years ago have problems in terms of earthquake resistance.

However, due to a building's situation, it is often difficult to implement all the needed countermeasures at the same time. Therefore, the Japan Elevator Association recommends seismic retrofits in the following way.

1. To establish an order of priority for countermeasures and carry them out in stages. The priority should be first, the safety of human life, complementing the operational limit strength, increasing the operational limit strength and finally establishing measures for reducing confusion after an earthquake.
2. Some elevators installed before 1998 earthquake-resistant design standards include members, such as rails, rail brackets, and intermediate beams, which are difficult to strengthen. In these cases, at least earthquake resistant class B of 1998 earthquake-resistant design standards should be applied (Table 1).

Earthquake-proof conversion of all existing elevators, 700,000 units across the nation, is an important issue that will require continuous monitoring.

### Operation and restoration of elevators after earthquakes vary depending on connections with the surrounding building elements

Hoistways are required to be fail-proof fire compartments; they must maintain their fire compartment function even if their walls are damaged during an earthquake. These walls are not regarded as non-structural walls. Even when they are made with ALC panels, they should be built with adequate earthquake-resistant construction by taking into account seismic motion. If a door frame or a sill of an elevator is deformed, even a little, from being pushed by the building's walls or floor, the door may not open or the elevator may not stop at the level of the floor. In Japan, elevators have very high accuracy with a clearance of just a few millimeters. The earthquake resistance of not only elevators but also walls and floors need to be improved.

### Ensuring barrier free elevators and escalators

In the aftermath of the Great East Japan Earthquake, many elevators and escalators did not work or were suspended, in part as an energy saving measure. The environment suddenly returned to the situation before barrier free living, and the elderly and the handicapped experienced much difficulty at stations and buildings. It is evident that with the coming of the super-aging society and the compact cities of the future, the safety and maintenance of such vertical movement devices as elevators and escalators will become increasingly important.

(Kazuo Adachi)

□Source of figures

1) Japan Elevator Association, Shokoki gijutsu kijun no kaisetsu (Interpretation of Technical Standards of Elevators), 2009

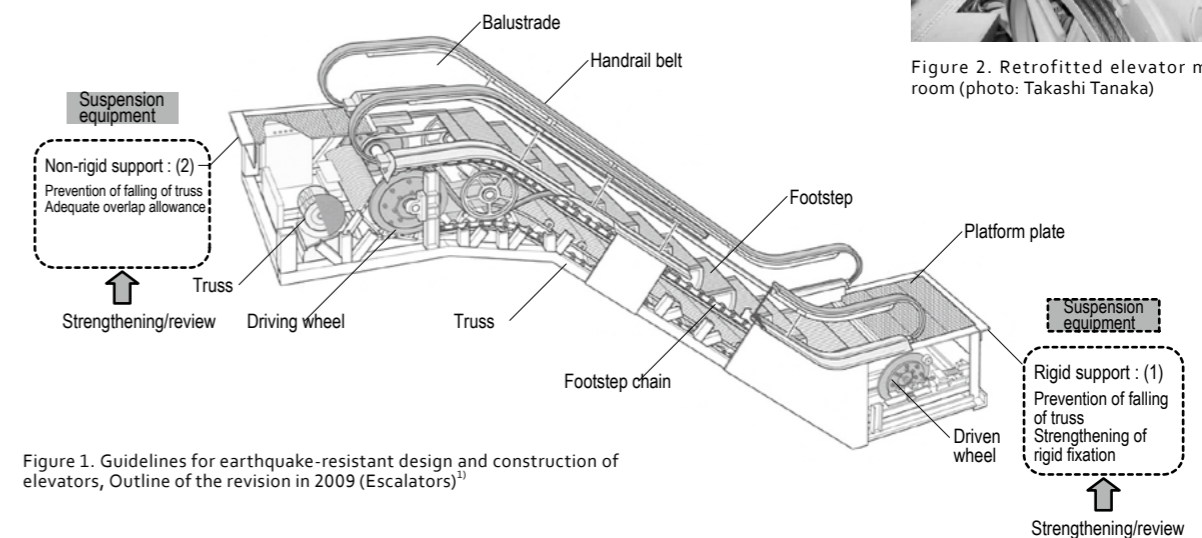

Figure 1. Guidelines for earthquake-resistant design and construction of elevators, Outline of the revision in 2009 (Escalators)<sup>1)</sup>

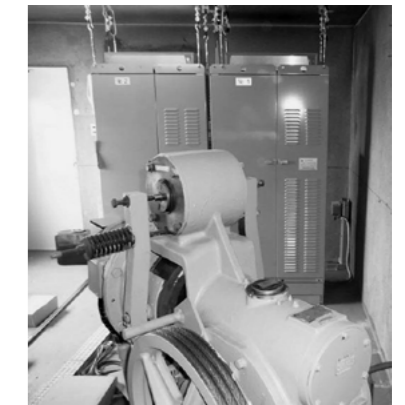

Figure 2. Retrofitted elevator machine room (photo: Takashi Tanaka)

Order of priority	Earthquake countermeasure item	Content of the item
Safety of human life	Installation of emergency operation equipment	Install emergency operation equipment
	Prevention of suspension equipment's overturning/movement	Take countermeasures for equipment including winding machine, motor-generator, and control panel, according to the standard in Chapter 7
	Prevention of coming off of main rope, etc. from the sheave	Take countermeasures to prevent coming off of main rope, etc. from the sheave, according to the standard in Chapter 7
	Prevention of falling off of counterweight blocks	Take countermeasures to prevent falling off of counterweight blocks, according to the standard in Chapter 7
	Protection (of main rope) against projecting objects within the hoistway	Take countermeasures for main rope to prevent tangling with projecting objects, according to the standard in Chapter 8
Complementing operational limit strength	Protection (of long objects except main rope) against projecting objects within the hoistway	Take countermeasures for governor rope, counterweight rope, travelling cable, and other objects to prevent tangling with projecting objects, according to the standard in Chapter 8
	Prevention of derailment of guide shoe, roller guide, etc.	Set up a stopper which meets the standard in Table 6-2-1 to the guide shoe or the roller guide whose overlap allowance of stopper is not adequate
	Installation of power supply equipment for automatic landing device for elevator in case of blackout	Install standby power supply equipment for automatic landing device for elevator in case of blackout, according to the standard in Chapter 3
	Installation of emergency operation against swinging of long objects	Install emergency operation against swinging of long objects, according to the standard in Chapter 9
Increasing operational limit strength and establishing measures for reducing confusion after an earthquake	Strengthening of guide rails, rail brackets, intermediate beams, etc.	According to the standard in Chapter 6, with verifying strength of guide rails, intermediate beams, rail brackets, etc. against seismic force, take countermeasures including mounting tie brackets or intermediate stoppers, strengthening of intermediate beams and rail brackets
	Provision of information	According to the standard in Chapter 3, provide elevator operation information to passengers in the cage and in the elevator halls in order to prevent confusion during and after an earthquake

Table 1. Order of priority in seismic countermeasures for existing elevators (numbers of chapters and tables in this table are those in the source 1) above)<sup>1)</sup>

## 10-1 Earthquake-resistant design and construction methods of wooden houses

Watch the images of wooden houses quaking in an earthquake and burn the images of their collapse into your memory; this will give you a good idea how to create the earthquake-resistant design of a wooden house. To stand firm, the building should be rigid as a whole and needless to say, the connections of frames should be rigid, too.

There are three ways for a building to handle the lateral vibration of an earthquake; to stand firm by force, to control vibration by using a device, and to reduce vibration by using a device to isolate the building from the ground; they are respectively known as earthquake resistance, response control, and seismic isolation.

### Earthquake resistance

A wooden house does not require any detailed structural calculation; it just needs a simple wall quantity calculation. The key is to imagine how the building would collapse in an earthquake and to consider which part of the structure should be strengthened to prevent such a collapse. Movies of full-scale tests of buildings (vibration tests) are posted on the website of E-Defense in the Hyogo Earthquake Engineering Research Center, National Research Institute for Earth Science and Disaster Prevention. It is useful to keep these images of collapsing buildings in mind when designing a wooden house. When the rolling motion of an earthquake starts, buildings also roll from side to side. While a building is rolling it does not collapse. It is only after it rolls to the side and it cannot return or hold on, that it collapses. The inclined angle at this moment is called the limit deformation angle. The basic concept of the earthquake-resistant design of a wooden house is for the building to stand firm by employing bearing walls and increasing the rigidity of the building in order to limit the increase of this angle.

#### 1. Wall quantity calculation

A bearing wall of a wooden house is "a post and beam structure with an integrated wall or a brace" which when it is placed in the X and Y direction on each story can limit deformation caused by seismic forces. Article 46 of the Enforcement Order of the Building Standard Law of Japan prescribes the number and dimensions for walls per unit floor area of each story (required wall quantity). Bearing walls are classified according to the materials used for posts and beams, and ratios of wall strength are designated against an onuki brace as a standard with a ratio of 1.0 (wall ratios) (an onuki brace is a horizontal element which connects columns and strengthens horizontal rigidity). When a total wall quantity calculated with these rates exceeds the required wall quantity, the building is considered to meet the standard (wall quantity calculation). Here, the wall ratio of 1.0 means that the bearing wall holds the allowable strength against a horizontal force of 1.95 kN per unit wall length of 1 m. This strength is determined as about 1.5 times the value estimated from a full-scale unit test. This is because consideration is given to possible effects that can be expected in actual buildings from non-bearing walls, spandrel walls, hanging walls, etc., which are not included in the calculations as bearing walls. However, recent buildings sometimes avoid hanging walls in order to make openings as large as possible, or expose braces without covering them with walls. In these

cases, the effects above cannot be expected. Therefore, sufficient allowance should be included in wall quantity calculations in earthquake-resistant design. In the case of wooden buildings, designing to include additional space of about 50% would affect the cost very little.

#### 2. Layout of bearing walls and horizontal rigidity

In addition to adequate bearing walls, ensuring the satisfactory rigidity of the building as a whole is equally important, in order to ensure the bearing walls work appropriately. This means that floors are rigid and the weight of the floors must surely propagate to the bearing walls (Figure 1). Moreover, bearing walls should be arranged with good balance. When bearing walls are not balanced, any section with many bearing walls will deform less, and sections with less bearing walls roll more greatly. Instead of calculating an eccentricity ratio with structural calculations, a method to verify the ratio with a simple calculation (tetrameric method) is established. First, the designed wall quantity and required wall quantity within a range from both ends of the building to a 1/4 of the building's length (side-end portion) are calculated. Secondly the ratio of designed wall quantity to the required wall quantity (wall quantity filling rate) is obtained for both ends of the building. Then divide the smaller wall quantity filling rate by the greater wall quantity filling rate to obtain the wall rate ratio. When this ratio is 0.5 or less, it is considered that the two ends will roll differently and the building will be subject to considerable twisting. This consideration is taken in both the X and Y directions, and when the ratio is 0.5 or less, the balance of bearing walls should be altered.

#### 3. Joints

In Notification No. 1460 of the Ministry of Construction of 2000, jointing methods of brace ends are prescribed in accordance with the types of braces (wall ratios) so that a framework with a brace can exert strength. Moreover, the Notification prescribes how to attach hardware in accordance with the types of bearing walls (wall ratios) so that column tops and column bases are adequately tightened to sills and horizontal members. Recently, designs with fewer walls have increased, and bearing walls with greater wall ratios are often used. The greater the wall ratio, the greater the tensile force, and therefore, a more secure jointing method is required. A movie of the test by E-Defense shows the column bases of the first story coming out from the sills.

Applying the prescriptions of the Notification on column tops and bases sometimes requires too much hardware. Or sometimes how to deal with types of frameworks or bearing walls not prescribed in the Notification is not known. For such cases the interpretation of the Notification recommends a simple calculation method, the N value calculation method, which verifies that the tensile strength of the part exceeds the required strength. A variety of simple PC software for the N value calculation method is available now. Here, a few key points to note are given.

1) The N value calculation method is used for calculating tensile strength from wall ratios in a simple way. The formula below shows the relationship between tensile strength and N value.

$$N \text{ value} = \text{tensile strength (kN)} / 1.96 \text{ (kN/m)} \text{ (wall ratio: 1.0)} \\ \times 2.7 \text{ m (wall height)}$$

- 2) A corner column has a greater N value because the restraining effect by upper load is less at this point. Hardware with a greater strength, such as a hold-down fastener is often required at such sections.
- 3) When a single brace at a projected corner column is connected to the column base, N value is less than when it is connected to the column top.
- 4) The smaller the difference between the wall ratios at both sides of a column, the smaller the N value.
- 5) When the result of N value calculation is translated into hardware, it often requires so many kinds of hardware that mistakes may occur in the construction and installation. It is better to limit hardware to a minimum number of different types.

Today, people rely on calculations too much, and not just in architecture. Because the N value calculation method is just a simple calculation method, the result of calculation should be regarded as only giving a rough indication, and be used with sufficient understanding of its limitations.

### Response control

The damage to wooden houses during the Great East Japan Earthquake was less than that in the Great Hanshin-Awaji Earthquake. Wooden houses are prone to collapse when the period of seismic motion exceeds 1 second. Because the period of seismic motion during the Great Hanshin-Awaji Earthquake was 1.0 to 1.5 seconds, many wooden houses collapsed due to the resonance. On the other hand, it is said that because the period of the Great East Japan Earthquake was 0.5 to 1.0 second, most wooden houses escaped damage. As can be seen, it is difficult to exactly predict the results of earthquakes. Dampers exert their effect at the time of a medium to great earthquake, and therefore, bearing walls should not be eliminated. Whereas an earthquake-resistant structure stands firm by force, a seismic-response controlled structure is a rational structure which flexibly lets seismic force through after standing firm to a certain degree. Dampers include oil dampers (Figure 2), rubber dampers, and friction dampers. Designers should select the most acceptable seismic-response controlled structure.

### Seismic isolation

When a seismic-response controlled structure is adopted, the cost increases by about 400,000 yen, in addition to the construction cost of the bearing walls. And in the case of a seismically isolated structure, it increases by about 3 to 4 million yen. When a seismically isolated structure which uses sophisticated devices is adopted, the damper should be selected with careful consideration to the cost. *(Yoshio Shimada)*



Figure 1. Ensuring horizontal rigidity with a catwalk and a horizontal brace



Figure 2. Seismic-response controlled structure using oil dampers

## 10-2 Seismic retrofit of wooden houses

Most wooden houses that were built in accordance with old earthquake resistance standards were built with a conventional wooden construction. In the light of present earthquake resistance standards, which have been enhanced by repeated revisions of the Building Standard Law of Japan, many of them are evaluated as 0.3 to 0.5.

### Progression of earthquake resistance standards

It is said that comprehensive and public discussions on the earthquake resistance of wooden buildings started in response to the great damage suffered by wooden buildings in the 1891 Mino-Owari Earthquake. However, it was not until the amendment of the Urban Building Law in 1924, one year after the 1923 Great Kanto Earthquake, that requirements for braces as an earthquake resisting element were included. This was the first time prescriptions for the earthquake resistance of wooden buildings were enforced by law. In 1950, two years after the 1948 Fukui Earthquake, which caused 3,900 deaths and the collapse of 36,000 buildings, the Building Standard Law of Japan was established and prescriptions of wall quantity were introduced for the first time. Later with amendments in 1959 and 1981, requirements for wall quantity were strengthened. In 2000, an important amendment concerning wooden houses was implemented; it included defining the types of foundation in relation to the bearing capacities of soil, methods for the layout of bearing walls, and methods for fixation of braces, column tops and bases.

### Existing non-conformed buildings

It can be said that most existing buildings have some form of non-conformed factors (Table 1). In the seismic retrofit of wooden buildings this issue is inevitable.

When a new construction falls under a category of an extension or a structural alteration, it is subject to an application for building confirmation. In such a case, present standards are retroactively applied, thus the fire prevention of sashes or repair of foundations may be required, which may impose an inordinate burden of expense. Allowing that the construction is certified under the Act on Promotion of Seismic Retrofitting of Buildings, all structural prescriptions are applied. Large extensions or structural alterations to old wooden houses facing minor streets, etc. are difficult to implement because they cannot withstand the application of structural prescriptions. If the application of structural prescriptions is avoided by limiting the work to a partial retrofit, the policy for the widening of narrow streets is rendered ineffective. It appears that regulations and construction costs are hampering seismic retrofits. In such cases, it is important to determine whether retrofitting or rebuilding is better.

### Promotion of seismic retrofits

Although it is an urgent critical issue to increase the number of wooden houses which comply with standards for earthquake resistant design after 1981 without waiting for a new-build at the end of a building's life, for a variety of reasons such initiatives are not making good progress, as listed below.

1. No sense of urgency concerning seismic disasters.
2. No understanding of the effectiveness of seismic retrofit work.

3. No trust in contractors.
4. Limited funds for construction work.

In addition to the above, there are more personal reasons, including issues of aging and health.

### Wooden houses after the new earthquake resistance standards

A variety of subsidies are now available for the promotion of seismic retrofits aiming at those buildings which were built in accordance with old earthquake resistance standards. Regarding wooden buildings, the required quantity of bearing walls increased with the amendment of standards in 1981. However, it was not until the amendment in 2000, after the Great Hanshin-Awaji Earthquake, that measures to adequately ensure their functions were concretely defined.

The amendment in 2000 defined specifications of foundations, braces, and frameworks.

Looking at recent seismic damage, many framework collapses were due to the pulling-out of columns or the twisting of frameworks caused by imbalanced arrangement of braces. In the future, the seismic retrofit of wooden houses built before 2000 should be considered as well.

### Seismic diagnosis and reinforcement design

Seismic diagnoses of wooden houses include simplified diagnosis, general diagnosis, and detailed diagnosis depending on the level of difficulty.

1. Simplified diagnosis: A self-diagnosis by the building resident/owner with the aim of spreading awareness of the need for seismic conversion among the general public.
2. General diagnosis: A visual inspection by qualified architects, etc. to assess the need for seismic strengthening.
3. Detailed diagnosis: Qualified architects or structural engineers diagnose whether the building needs seismic strengthening, and estimate the expected earthquake resistance after strengthening, based on detailed information on the building.

Except for the simplified diagnosis, buildings are evaluated based on the following ratings of the superstructure.

- 1.5 or more: The building will not collapse.
- 1.0 or more, and less than 1.5: The building is not likely to collapse.
- 0.7 or more, and less than 1.0: The building may collapse.
- Less than 0.7: The building is likely to collapse.

When the rating is less than 1.0, the building should be given seismic strengthening. Most wooden houses that were built in accordance with old earthquake resistance standards more than 30 years ago are evaluated as 0.3 to 0.5.

Various construction methods for the seismic strengthening of building elements including foundations, sills, walls, and openings have been developed. Some of them have a function of seismic isolation or response control. Most seismic retrofit works cost under 3 million yen and take less than several weeks to complete.

Based on the results of a detailed diagnosis of a building, seismic strengthening work is planned and detailed architectural drawings are created. At that time, it is important to ensure the client has a good grasp of the building's earthquake resistance after the work. In addition, the client should also understand that the rating obtained by calculations and the behavior of the building during an actual earthquake will not

necessarily match.

Very often such seismic strengthening work to existing houses is carried out while the residents continue to live in the building; a works schedule should be arranged to minimize disruption to daily life (Figures 1, 2, 3 and 4).

### Supervision of seismic retrofit work

Unlike when constructing a new build, sometimes in the seismic retrofit of an existing building, an unforeseen difficulty is found preventing the plan being followed. In such a situation, the supervisor should clearly explain and assure the client why changes in the plan are needed, how the changes should be made, what the cost will be, and so on; this will

prevent any problems later. If any deterioration of the building or defects due to past work is found, additional strengthening work may be needed. Therefore, the supervisor should have a sound grasp of wooden structures and an ability to adapt to sudden changes in circumstances on site. It is a prerequisite for anyone who designs and supervises seismic retrofit work to operate with an adequate understanding of not only structural engineering, but also the client's everyday life and expectations.

Because the cost of seismic retrofit works are usually not great, the work is sometimes completely left to a contractor. However, appropriate supervision is essential to prevent sub-standard work by contractors (Figure 5). (Shoeki Kurakawa)

By construction year, the number of wooden houses	
Before 1951	1,796,300
Between 1951 and 1981	11,494,900
Between 1981 and 2000	5,690,700

Table 1. Currently 5,700,000 wooden houses are non-conforming buildings constructed after new earthquake resistance standards and before 2000 (based on 2008 Housing and Land Survey, Ministry of Internal Affairs and Communications)



Figure 1. The state immediately after construction commenced. Construction started from the interior work leaving exterior walls as they were.



Figure 2. Addition of new foundation and sill, and strengthening a column base.



Figure 3. Lack of a beam on the second floor was found after the work started, and a beam was added.



Figure 4. An effective improvement to the building can easily be achieved by carrying out seismic retrofit and renovation at the same time. Cost effectiveness is also good.



Figure 5. There are still many sub-standard seismic retrofit works.

### 10-3 Residential environments and disaster prevention in densely crowded areas of wooden buildings

In older districts densely crowded with wooden buildings, dilapidated houses are very common and present considerable danger from collapse and fires at the time of great earthquakes. Physically, such districts are cramped with few public spaces and their residential environment has many problems, but socially, they have many positive attributes, including the fostering of close community ties, which are often missing in more modern layouts and multi-storied buildings.

#### Area densely crowded with wooden buildings

Areas densely crowded with wooden buildings are often laced with many minor streets and spotted with densely crowded small lots packed with buildings. In addition, there are often many dilapidated wooden houses (Figures 1 and 2), and very few open spaces such as parks and public facilities, all of which contribute to these areas having problems in terms of not only disaster prevention, but also the residential environment. In 2003, the Ministry of Land, Infrastructure, Transport and Tourism announced a priority list of densely built-up areas in need of development. The standards stipulate that the ratio of noncombustible area<sup>(1)</sup> is less than 40%, and the residential density is 80 dwellings/ha or more. A total area of 8,000 ha was classified; the Tokyo and Osaka areas each accounted for 2,000 ha.

The Tokyo Metropolitan Government identified about 16,000 ha of areas densely crowded with wooden buildings<sup>(2)</sup> whose ratio of noncombustible area is less than 60%, based on present-state surveys on land use in 2006 and 2007. These urban areas, which account for 25% of Tokyo ward areas, were mostly located along the loop roads of Tokyo and created through the rapid increase of population after World War II.

These areas are being developed with a goal of a final ratio of noncombustible area of 70% including rebuilding at a building's life end.

#### Problems of areas densely crowded with wooden buildings

The key practical measures for enhancing safety and disaster prevention of areas densely crowded with wooden buildings include the widening of roads, fireproofing and seismic conversion of buildings along roads, etc. However, the widening of roads or land readjustment sometimes reduces the area of lots or results in relocation. In addition, the fireproofing and seismic conversion of buildings require some expense, these sort of problems need to be solved, and therefore any improvement is making slow progress.

The local governments of areas densely crowded with wooden buildings are addressing such issues with a variety of measures and policies in accordance with an area's characteristics. The rebuilding of dilapidated wooden houses is an especially important part in any such initiative. The relations of property rights including leased land and subleasing are often complicated, and in addition the aging of residents and the consequent increase of vacant houses also needs to be considered.

#### Alleys and disaster prevention

Areas densely crowded with wooden buildings which

include a lattice-like pattern of alleys are especially prone to catching fire during an earthquake. The blocking of roads due to buildings collapsing cause serious problems for escape, evacuation, rescue and fire-fighting (Figure 3), all of which have been seen many times in past great earthquakes.

The Building Standard Law of Japan defines a "road" as a thoroughfare whose width is 4 m or more. However, any roads that existed at the time of the establishment of the Building Standard Law of Japan (a so called substandard road) are considered as roads despite their being under width. These roads have to be widened at the time of rebuilding or extension. However, despite more than 60 years having passed since establishment of the Law in 1950, there still remain a lot of substandard roads (Figure 4). There also remain many sites that are not compliant with stipulations concerning connecting roads. While the buildings were refurbished in some way, roads were left untouched; therefore widening of roads to 4 m has not progressed as expected. It seems that measures such as more effective policies or reviewing the prescription of a substandard road itself are necessary.

In addition, utility poles are not only fixed obstacles in roads, but can also become a hazard in a disaster, such as an earthquake. It is desirable to improve the landscape and disaster prevention performance of roads by simultaneously implementing the widening of minor streets and laying power lines underground.

#### Mini development

In the areas densely crowded with wooden buildings, a lot of mini developments of ready-built housing including 4 to 6 houses located on former factory sites are seen (Figures 5 and 6). Many of these mini developments include a central 4 m road surrounded by 3 story houses; many are cul-de-sacs. Currently they pose many problems, as because the site is subdivided and crowded with houses, two-way escape is not possible, and in the future when these houses become dilapidated, the sites may not be renewable in any way and may become dangerous densely-built areas.

Recently, instead of allocating roads within a site, mini developments are often seen, where the narrowly extended parts of lots are regarded as roads (or, flag-shaped sites). Packing many lots into the sites, instead of organizing the sites and creating open spaces, does not improve the risk of areas densely crowded with buildings. It seems that now is the time to review the relationship between sites and roads.

#### Efforts to improve areas densely crowded with wooden buildings

As an example of efforts by local government, a unique administrative initiative has been attracting attention in Sumida Ward, Tokyo, where subsidy policies for the seismic retrofit of a part of a building, and the combination of barrier-free, seismic and fire-safety retrofit are being tried out.

Approximately two-thirds of the wooden houses in Sumida Ward were built in accordance with old earthquake resistance standards. According to the estimation of earthquake damage published by the Tokyo Metropolitan Government in 2006, the collapse ratio of wooden houses exceeded 30%.

As a result of the "Re-examination of Fireproofing Promotion Project of Sumida Ward" in 2006, it was found that the northern part of the ward, which is more densely crowded

with wooden houses than the southern part was more prone to the spread of fire in an earthquake. In response to this result, the following five measures for the development of disaster-proof communities were recommended.

1. Ensure firebreaks along escape routes
2. Improve the earthquake and fire resistance of the areas densely crowded with wooden buildings
3. Build social housing stock of good quality
4. Raise resident awareness of the development of disaster-proof communities
5. Promotion and institutionalization for cooperative development of disaster-proof communities

Ensuring firebreaks was a top priority issue because the ward has experienced big urban fires many times in its history. Therefore, the ward using the previous examination, has designated certain areas as vulnerable to fire along with areas bordering arterial roads, and has been encouraging rebuilding by providing residents with free consultations with architects and financial advisers. While valuing the friendly atmosphere of the traditional commercial and working-class neighborhoods, and aiming to improve safety, a coalition of the public administration, community residents and expert groups are all cooperating to address disaster mitigation, and the initiative is receiving good support from neighborhood associations.

(Shoeki Kurakawa)

- Note
- (1) Ratio of noncombustible area: See Note of Section 14-3.
  - (2) In the Improvement Program of Districts with Close-set Wooden Houses in Tokyo, any area (town and district) which falls under all of the following is defined as an area densely crowded with wooden houses.
    1. The ratio of wooden buildings (\*1) is 70% or more.
    2. The ratio of dilapidated wooden buildings (\*2) is 30% or more.
    3. The residential density is 55 dwellings/ha or more.
    4. The ratio of noncombustible area is less than 60%.
- \*1 Ratio of wooden buildings: Number of wooden buildings / Number of buildings  
 \*2 Ratio of dilapidated wooden buildings: Number of wooden buildings constructed in or before 1970 / Number of buildings
- Source of figures
- 1) Based on "Creation of a Highly Disaster-resistant City," 2010, Tokyo Metropolitan Government



Figure 1. An area densely crowded with wooden houses  
 Figure 2. A close alley space

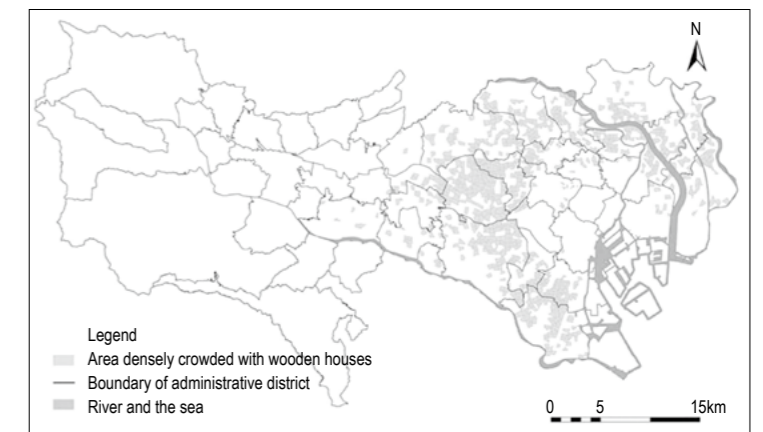

Figure 3. Circularly-distributed areas densely crowded with wooden houses in Tokyo<sup>31</sup>



Figure 4. A substandard road, the widening of such roads has not progressed as much as expected.

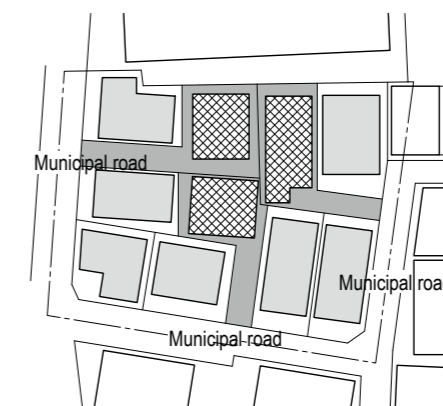

Figure 5. An example of mini development. A former factory site was divided into 10 lots and sold. The lots are extended to fulfill any legal or contractual requirements for connecting to a road.

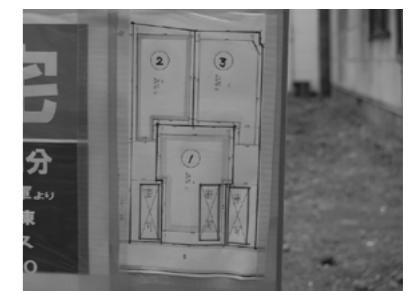

Figure 6. A former residential site was divided into 3 lots and sold.

# 11 Supervision of Construction and Follow-up after Completion

## 11-1 Quality of construction makes a difference in earthquake resistance performance

After the Great East Japan Earthquake, even though the following tsunami caused considerable damage, not many buildings collapsed because of the earthquake itself. Obviously when reviewing past earthquakes, much damage would have been avoided and many of the collapsed buildings would have remained standing, if they had been built to more modern standards. In addition, the performance of the earthquake resistance of non-structural elements always requires a review after their being subjected to an actual earthquake.

### Non-conforming works observed at the past earthquakes

In past earthquakes, the simple failure to conform to standards resulting in non-conforming work has caused great damage to building frames, with a consequent loss of human lives. Table 1 shows examples of typical non-conforming works.

Although the quality of finishing work is apparent, when construction is completed, in most cases, building frames are not visible. Such non-conforming works as shown in the table are the result of human error or neglect and could have been prevented if the building works were diligently and competently supervised. Not only contractors but also supervisors should be questioned regarding their responsibility for such sub-standard work.

### Evaluation of earthquake resistance depending on the quality of construction

The strength and quality of a building depends on many elements. In the case of a reinforced concrete construction that supports a building by the compressive force of concrete and rebar tensile force, for example, a high-quality building is realized only when all factors, such as structural planning by an architect, structural design including structural calculations, competent fabrication and rebar assembly on site, properly fabricated formwork that ensures the appropriate thickness of covering concrete, and properly cast concrete of the appropriate quality are all achieved to a high standard. Although each element includes safety margins to allow for human error, if a large error occurs in a certain factor, the quality of the building drops dramatically, as succinctly described in the old adage, a chain is only as strong as its weakest link. However, when the set criteria for all factors are exceeded, the performance of the building will greatly exceed the original expected performance goals.

### Earthquake resistance of non-structural elements

During the Great East Japan Earthquake, the damage to non-structural elements in terms of earthquake resistance was great.

Many ALC panels, used for the exterior walls of steel structure, etc., were extensively damaged. In particular, the more traditional and widely-used rebar-inserted longitudinal wall construction suffered more damage than the more recently popular rocking construction.

Ceilings also suffered considerable damage; especially, extensive damage in large spaces, such as auditoriums, and low-rise commercial buildings was reported. Regarding ceilings, technical standards have been published including "Measures

against falling of ceilings in buildings with large spaces" by the Ministry of Land, Infrastructure, Transport and Tourism and "Recommendations for Aseismic Design and Construction of Nonstructural Elements" by the Architectural Institute of Japan. However, the amount of ceiling damage raises the question whether designers understand or are applying these standards. While preparation of new standards is expected, it is necessary to recognize the importance of ensuring the earthquake resistance performance of non-structural elements in just the same way as happens with building frames.

### Accumulation of safeties toward security

It is said that the Japanese are a people who stick to the art of design and manufacturing; the phrase "artisan spirit" has been commonly used in Japan. However, under the present economic environment, the construction industry is suffering from aging and a shortage of successors. The construction of buildings in Japan should be based upon each engineer demonstrating their skill to the utmost along with great pride in their work. The present situation of the drain on basic technology, caused by the over fixation on high-tech, needs to be changed as soon as possible. In tandem and from the standpoint of engineers, there is also a need to ensure "security" by accumulating technological "safeties."

The Great Hanshin-Awaji Earthquake, revealed an enormous amount of non-conforming work, but these structures were quickly demolished or hidden (Figures 1 and 2). After the Great East Japan Earthquake, it would appear that damage, especially to interior finishes, was often simply not reported. Although it is important to inquire into the responsibilities of designers or contractors, the most important point is to acknowledge any occurrence of damage, uncover the causes and accept them as lessons from which to learn and propose corrective measures to prevent any recurrence. (Figures 3 and 4).

*(Hiroshi Inoue and Jo Koshi)*

Non-conformity of concrete work	Use of concrete with non-conforming water-cement ratio and strength poverty due to excessive water
	Collapsed building frame of concrete due to the use of salty sea sand or alkali aggregate reaction
Non-conformity of building framework	Non-conforming concrete placements such as placement with mixed bottles/cans, wood chip/wood blocks, cotton work gloves, and cigarette butts
	Neglecting or non-conforming gas pressure welding of column bars
	Collapsed column due to non-conforming correction of mistakenly placed anchor bolts, etc.
	Bearing wall whose cold joint ruptured before shear cracks were produced
	Column broken at rock pocket by applied pressure
	Column or beam whose concrete exfoliated and rebar buckled due to concrete cover being too thin
	Column or beam with exfoliated concrete due to a hoop end not being sufficiently clinched
Non-conformity of steel and welding work	Fall of cantilever slab due to lack of strength
	Fracture of post-construction anchor
	Box column whose JIS-incompatible diaphragm was fractured
	Column or beam fractured due to defect of butt welding of flange
	Deformed column base caused by failure of anchor bolt due to non-conforming correction of mistakenly placed anchor bolts, etc.
	A stud supporting beam which produced local buckling due to lack of stiffener at the base of a braced stud
	Brace fractured at joint before able to apply support
Buckling of column whose concrete encased box at the base was not filled with concrete	

Table 1. Examples of typical non-conforming works and causes



Figure 1. During the Great Hanshin-Awaji Earthquake, civil engineering structures and buildings suffered great damage, resulting in the public losing their trust in such constructions.



Figure 2. The speed of demolition after the Great Hanshin-Awaji Earthquake raised public suspicions.



Figure 3. This overturned building in Onagawa-cho, Miyagi prefecture will be preserved as a demonstration and reminder of the threat of a tsunami. It will also help in the investigation of the tsunami and its effect on the building.



Figure 4. At the time of the Great East Japan Earthquake, many steel structures suffered damage; investigations into the validity of their construction methods need to be held.

## 11-2 Points for the selection of a contractor

In past earthquakes, many buildings suffered damage due to human error and neglect, such as simply poor workmanship or non-conforming works. Awareness of the importance of the supervision of contractors has increased since the scandals concerning the fabrication of earthquake-resistant strength and non-conforming work. The final quality of a building depends as much on the quality of drawings and specifications designed by architects, as well as the quality of the contractor.

### Quality of the construction depends on the quality of the contractor

In the present socioeconomic circumstances, contractors may accept a price for a contract, which can only be met by a lowering of quality standards and using cheaper materials. In addition, an aging workforce and a shortage of new builders may have caused a decline in technological competence. Therefore, the selection of a contractor requires a comprehensive examination of many factors including the overall quality of the contractor, their attitude toward construction, performance assurance and follow-up after completion, quality of the site agent, level of technological competence, and relationships with subcontractors. The quality of construction depends on the quality of the contractor.

### Responsibilities of a designer and a supervisor, and responsibilities of a contractor

The scandal of fabrication of earthquake-resistant strength only went to underline how important it is for a contractor to diligently build a construction in strict accordance to the drawings and specifications. Therefore, as the foundations of construction, the quality of a building depends on the quality of drawings and specifications.

A designer must make drawings and specifications as precisely as possible. However, it is not possible for any designer to make drawings free of errors. A contractor based on their experience should attempt to find and improve defects in the drawings.

### Construction of good quality through fair selection of contractors and at a reasonable price

A contractor can be selected in a variety of ways including competitive bidding, negotiation with estimates, and a negotiated contract. The architect's basic responsibility is to just select in a fair manner a contractor who will build a construction of good quality at a reasonable price taking into account the perspective of the residents or users of the building.

### Performance specification contracts and the assurance capability of contractors

Legal provisions of building construction are shifting from traditional specification code to performance code. Therefore, contractors are required to have the ability and quality to carry out work that will meet the performance specified in the design, ensure the quality of construction, and be a company with a healthy business management that can bear the responsibility for a long term performance assurance period.

### Site agent and subcontractors

The quality of any construction varies depending on the capabilities, work attitudes, and diligence of the site agent. Although a highly capable field director and staff can ensure a construction of good quality, the reverse case will lead to a loss of quality and the supervisor sometimes having to cover the field director's role. The constitution and skill levels of construction engineers as well as the level of in-house technical education are important. In addition, because every building is a tailor-made project, the skill levels of workers determine the quality of the building. The relationship of a general contractor with subcontractors and groups of workers is also important when selecting a contractor.

### Quality of a building depends on the quality of design

The quality of a building depends on the level of quality and completion of drawings and specifications designed by architects in cooperation with structural and utilities engineers. When drawings and specifications clearly incorporate the architect's ideas, are logical and depicted in detail, and reflect the architect's enthusiasm for the project, such a combination of factors will attract a contractor who wants to be positively involved in the build. On the contrary, when the overall plans and attitude are perfunctory and do not reflect the architect's ideas or enthusiasm, then the quality of construction will only be lackluster. It is obvious that architects should make drawings and specifications that positively and passionately fill the contractor with enthusiasm for the project (Figures 1 and 2).

### Towards reducing claims

It is known that claims regarding buildings are mostly about noise, vibration, condensation, and water leakage. Although they might appear to be the direct result of utilities work, in practice they can be caused by architectural work. Condensation is not always due to utilities work, but is sometimes due to poor insulation specified in the architectural work. The first step toward reducing claims is to ensure the contractor of architectural work adequately understands the nature of utilities. When just before completion a contractor is required to rush construction work, adequate time for commissioning before delivery cannot be ensured, and this tends to increase defects and claims. Therefore, it is also important to select a contractor who can effectively control construction schedules.

### Selection of contractors of architectural and utilities works

Architectural work and utilities work are ordered separately or in one package. Or in some cases, the method called "Cost-on order" is also applied, in which contractors of utilities work and architectural work are selected separately, then the whole works including utilities work are ordered from the contractor of the architectural work with the addition of a supervision fee (cost-on) to the construction cost of the utilities.

### Selection of a contractor of utilities work

To be eligible for selection a contractor of utilities work should fulfill the following conditions.

1. The company is licensed according to the prescription of classifications in Article 3 of the Construction Business Act.
2. It has adequate capability to manage a project. It also

should have adequate finances and organization, including branch offices, etc. and staffs, and have an assured system of follow-up.

3. The company has a good reputation.
4. It has adequate technological capacity and capability for construction. It also has adequate experience with the construction type in question and has capable construction

agents.

5. It has experience of similar types of construction.

Points to note for buildings may vary depending on their use. Especially utilities work differs between houses, offices, hospitals, and so on. A track record in construction and experience of similar types of buildings are required for the contractor and the site agent. *(Hiroshi Inao and Jo Koshi)*



Figure 1. A bar arrangement inspection attended by the supervisor



Figure 2. Verification of materials at the steel frame manufacturing factory

### 11-3 Supervision of architecture, structure and utilities works

With the scandal of fabrication of earthquake-resistant strength in 2005, the way of thinking about buildings has shifted considerably. Relevant laws and regulations including the Building Standard Law of Japan and the Act on Architects and Building Engineers were widely revised. Especially, the importance of the role of supervisors at construction sites has gained a new recognition.

#### What is construction supervision?

As Paragraph 6, Article 2 of the Act on Architects and Building Engineers prescribes, "construction supervision is, under one's own responsibility, to check the construction against the drawings and specifications, and to verify whether it is implemented in accordance with the drawings and specifications." In addition, as Paragraph 3, Article 18 of the law prescribes, in implementing the practice, "when a qualified architect, during the construction supervision, verifies that the construction is not implemented in accordance with the drawings and specifications, he/she should immediately give notice to the contractor, and if the contractor fails to comply with the notice, he/she should inform the client accordingly." However, in actual practice, a range of activities wider than described above, that is, "practices relevant to the construction contract" and practices relevant to the "guidance and supervision of construction" prescribed in Article 21 of the law (Other practices) are also often implemented. Specifically, they have been defined as "standard practices relevant to construction supervision and other standard practices that are stated in Notification No. 15 of the Ministry of Land, Infrastructure, Transport and Tourism in 2009." The outline is shown below.

[Standard practices relevant to construction supervision]

1. Explanation of construction supervision policy, etc.
  - i. Explanation of the construction supervision policy
  - ii. Consultation for any change of the construction supervision method
2. Understanding the content of drawings and specifications, etc.
  - i. Understanding the content of drawings and specifications
  - ii. Consideration of a questionnaire
3. Consideration of working drawings, etc. as compared with drawings and specifications and reporting
  - i. Consideration of working drawings, etc. and reporting
  - ii. Consideration of construction materials and equipment, etc. and reporting
4. Checking of construction against drawings and specifications, and verification
5. Report of the results, etc. of checking construction against drawings and specifications, and verification
6. Submission of the construction supervision report, etc.

[Other standard practices]

1. Consideration of itemized statements of contract price and reporting
2. Consideration of progress schedules and reporting
3. Consideration of scheme of execution as prescribed in drawings and specifications, and reporting
4. Checking of construction against the construction contract, verification, reporting, etc.

- i. Checking of construction against the construction contract, verification and reporting
  - ii. Instructions, inspections, etc. as prescribed in the construction contract
  - iii. Destructive inspection when it is suspected that the construction does not comply with the content of drawings and specifications
5. Witnessing handover of the object of the construction contract
  6. Witnessing inspection by relevant authorities, etc.
  7. Examination of the payment of construction costs
    - i. Examination of the request for payment of construction costs during the construction period
    - ii. Examination of the final request for payment

In addition, the practices to inform design intentions in the construction supervision phase, as designer practices, have been defined as follows.

[Designer practices in the construction supervision phase]

1. Question-and-answer, explanation, etc. to exactly inform the design intentions
2. Consideration, recommendation, etc. from a perspective of design intentions for the selection of construction materials and equipment, etc.

#### Points of construction supervision

Recently the separation of design and supervision is becoming common. Against such a background, the points of construction supervision common to architectural, structural, and utilities works are as follows.

1. The supervisor should adequately understand the drawings and specifications and should thoroughly grasp the design intentions.
2. The supervisor should foresee inconsistencies in drawings and specifications, any details which are difficult to construct, and those parts which may cause future claims, and should inform the designer.
3. The supervisor should always explore ways to improve the quality and certain workability even when there is no specific mistake in drawings and specifications. When he/she has found such ways, he/she should propose the changes to the designer. The supervisor also should check drawings and specifications from the perspective of the contractor, and should explore ways to improve quality with the contractor (Figure 1).
4. The supervisor should at an early stage list the points where the contractor may be likely to make mistakes, as well as points that need attention in terms of techniques and works, consider countermeasures, and make the contractor thoroughly aware of them.
5. The supervisor should consider the schedule of construction and thoroughly grasp the progress of working drawings and shop drawings. Especially, if a delay occurs in fabrication, the construction schedule will be greatly affected and it will be difficult to recover lost time.
6. The supervisor should inspect the construction site checking whether it is in compliance with drawings and specifications as well as working drawings, and grasp the progress of construction.
7. Human errors are inevitable even if the greatest attention

is paid. Such errors should be thoroughly rectified, and not treated superficially.

#### Points of construction supervision by structural engineers

Although construction supervision of building structures should be left to reliable structural engineers, architects should also understand the points of the supervision.

##### 1. On ground conditions

Structural engineers should investigate in consultation with geological survey specialists. As a supervisor, the structural engineer should understand the investigation report and verify the level of bearing ground, likelihood of consolidation settlement, measures against ground liquefaction, and so on. When the building is large, it is important to judge if the number of investigating points are appropriate because the bearing ground is not always flat.

##### 2. On piling work

There are many different types of piling work construction methods including prefabricated piles such as PC piles, HPC piles, ST piles, and steel pipe piles, as well as field preparation piles such as earth drill piles, Benoto piles, under-reamed piles, head-enlarged piles, and head-and-under-reamed piles. Whatever method is adopted, soil is not investigated at all the pile positions. Therefore, the supervisor should be aware of how the contractor has verified that each pile has surely reached the bearing ground.

##### 3. On rebar

Since the scandals of fabrication of earthquake-resistant strength, it seems that contractor awareness of the importance of constructing in accordance with structural drawings and specifications has been raised considerably. The supervisor should know how the contractor verifies the accordance, and also must consider whether the verification is appropriate. Rebar joints play a very important role in propagating force. Pressure welding is usually used for the joints of D19 rebar or thicker. However, the performance of joints sometimes varies depending on worker skills and the working environment. The supervisor should check their skills and countermeasures against rain and strong wind. Recently, mechanical joints are sometimes adopted to ensure the stability of construction.

##### 4. On concrete

In recent years, the lifetime extension of buildings has drawn attention. Especially, the lifetime extension of concrete as a building frame is the most important factor. Not only the selection of ready-mixed concrete plants with thorough quality control but also ensuring the thickness of covering concrete, appropriate placing of expansion joints, etc. on site will greatly contribute to the lifetime extension of buildings.

##### 5. On steel work

To make a high performance steel frame structure, which is lighter and has greater ductility and strength compared to a RC structure, factory techniques of steel frame fabrication are needed, including ensuring different types of steel, and the strong and accurate welding joints of columns and beams. In addition, as in the case of pressure welding, because welding on site is required in most cases, checking worker skills, and countermeasures against rain and strong winds, and checking test methods are necessary.

##### 6. On non-structural elements, etc.

At the time of the Great East Japan Earthquake, damage

of non-structural elements including exterior finishes, curtain walls, and ceilings was greater than that of building frames because the quakes continued for a long time. Though preparation of standards with laws and regulations is an issue for the future, it is an important point that designers and supervisors should pay attention to now.

#### Points of construction supervision by utilities engineers

When supervising utilities work, it is important to understand design intentions and ensure the performance required for the building. At the time of the Great East Japan Earthquake, equipment as well as non-structural elements suffered damage including overturning, dropping off, and falls. Checking the methods used for attachment is also an important item of supervision. Moreover, many alterations to plans will occur during the construction of a building, and supervisors must be fully aware of the changes.

(Hiroshi Inao and Jo Koshi)



Figure 1. Meeting of designers, supervisors and the contractor



### 11-4 Performance assurance at completion and information management

Buildings will be used for a long period after completion, and it is important at the time of handover to explain the durability, earthquake resistance, maintainability, insulation and energy saving, etc. In addition, a detailed performance warranty stipulated by building element, long-term repair program, and precise as-built drawings and completion documents should be handed over. If there are discrepancies between the actual building and as-built drawings, etc., complaints of failing to build in accordance with drawings and specifications may be raised in the future.

#### Buildings will be used for a long period

After the completion of construction, the building's useful life starts, and how to use the building and a long-term maintenance plan should be given to the owner and the users.

#### Conveyance of information on performances of building

Depending on the degree of maintenance, there is no reason why a building cannot be used for between 100 and 200 years.

A building consists of building frames, non-structural elements (secondary building elements), waterproof materials, interior and exterior finishing materials, plumbing systems, air conditioning and ventilation systems, electric systems, and so on.

At the time of handover, it is essential to explain to the owner in layman's terms how long the building will be durable if it is maintained in a certain way, and equally important what procedures, renovations, etc. should not be carried out.

#### Conveyance of information on the earthquake resistance performance of a building

A building which is used for a long period may be affected by a great earthquake that occurs once in 50 years or a giant earthquake that occurs once in hundreds of years. Information should be provided explaining how the building frames, non-structural elements, waterproof materials, interior and exterior finishing materials, plumbing system, air conditioning and ventilation system, electric system, etc. have been designed to either be damaged or to limit damage and to what degree at the time of a great earthquake that occurs once in 50 years. Earthquake resistance performance and estimated damage as well as countermeasures for each building element should be included.

Likewise, for a giant earthquake that occurs once in hundreds of years, information should be provided on earthquake resistance performance and estimated damage as well as countermeasures by building element, including building frames, non-structural elements, and equipment.

#### Performance indicated houses are helpless against a tsunami

In response to disputes over defective houses, the Housing Quality Assurance Act on detached houses and apartment houses including condominiums was enacted after the Great Hanshin-Awaji Earthquake, and established a housing performance indication system (Table 1). With this system, indication of performances such as durability, earthquake resistance, energy saving, and sound insulation are now legal obligations.

However, the wooden houses and prefabricated houses built in the Tohoku region along the coast of the Pacific Ocean in accordance with this system were washed away by the tsunami following the Tohoku Earthquake. It was clearly shown that when a tsunami exceeds the height of houses, even if they were built in accordance with the housing performance indication system, they are helpless against a tsunami.

Although the standards of the system are effective for houses built in areas free from threat of a tsunami, the tsunami resistance performance of detached houses along a coast likely to be hit by a tsunami is zero.

#### Tsunami resistance performance of RC apartment houses

Mid-rise apartment houses constructed with reinforced concrete along the coast in Rikuzentakata, Iwate prefecture suffered damage to window glass and sashes, metal balustrades, etc. from a giant tsunami. However, building frames suffered no damage except the exposure of pile foundations due to scouring because the tsunami passed through the building, breaking window glass on the landside.

Damage of building elements due to scouring and that of non-structural elements such as sashes and metal balustrades could have been reduced if those buildings had been pilotis-type apartment houses constructed in accordance with earthquake-resistant design.

Building frames of pilotis-type apartment buildings, that let the tsunami pass through, and with a height of about two stories higher than the estimated tsunami height would ensure adequate earthquake resistance performance and tsunami resistance performance.

Moreover, human lives would be protected if evacuation routes to the upper stories and the roof are secured.

However, non-structural elements, such as interior finishing materials and the sashes of the stories where the tsunami passed through, will need renewing. The upper stories where the tsunami did not reach can be used again after utilities, such as systems for water supply and drainage, gas, and electricity, are restored.

#### Maintenance and long-term repair programs of buildings

Buildings should be maintained in such a way as to maintain the performance of those building elements that deteriorate over time.

There is no need to repair a building element just after its "performance warranty period" has expired. The performance warranty period is different from the "expected durable period" stipulated for a repair or a renewal. Reform agencies and condominium management companies tend to set building element cycles of maintenance shorter than they need be, so as to raise the repair costs for maintaining buildings and implement excessive repairs.

The fact of the matter is that appropriate repairs and renewals made considering both the "expected durability performance warranty period" in the design, and the actual deterioration conditions, will be adequate.

A "long-term repair program" is a summary of the expected durable periods, and outlines of repair specifications by building element that constitute a building (Figure 1).

Regarding maintainability, it is crucial to control running

costs in the long term, to improve the durability of building elements including building frames, non-structural elements, waterproof materials, finishing materials, plumbing and electric systems, and to design building elements to allow easy repair, maintenance and replacement at the time of renewal.

#### Completion drawings and documents should be carefully looked after

In the long term, buildings will naturally require large-scale repairs as well as improvements and alterations. Seismic diagnoses and strengthening works will also sometimes be implemented.

Completion drawings and documents as well as construction records are essential for an improvement design. However, it sometimes happens that structural calculation sheets or structural drawings, which are crucial, have not been

handed over, or discrepancies between the actual building and the as-built drawings are found because design changes during construction had not been reflected in the as-built drawings. In such cases, not only extra cost will be incurred for investigations and improvement design, but also accusations of failing to build in accordance with drawings and specifications may be made with the suspicion of corner-cutting in the construction or mistakes in the construction supervision. The evaluation of a building and the architect may be determined some 100 years later, by which time the architect will be dead.

(Tetsu Miki)

□ Source of figure

1) Kenchiku Shicho Kenkyusho, Data File of Architectural Design & Detail - vol.50: Maintenance and renewal of multiple dwelling houses, Kenchiku Shiryo Kenkyusha, 1995

Object of warranty		Warranty period	Exemption from application
Section to which warranty applies	Phenomenon covered by the warranty		
1) Building frame (including foundations, roof, balcony, stairs, and eaves)	Deformation or damage that affects structural strength	10 years	
2) Roof	Rain leakage or damage to building due to rain leakage	10 years	
3) Exterior wall (including joints with doors and windows)	Rain leakage or damage to building due to rain leakage	7 years	
4) Reservoir, elevated water tank, and septic tank (including pedestal)	Water leakage or damage to building (including tank) due to water leakage	5 years	Fittings other than main body
	Deformation or damage that affects structural strength	10 years	
5) Bathroom	Water leakage or damage to building due to water leakage	5 years	Bath units: when the phenomenon was caused by installing a stationary-type bathtub or hot water supply unit not compliant with BL specifications or the standards of the bath unit manufacturer

Table 1. Construction warranty standards of the Urban Renaissance Agency (UR) for condominium management associations

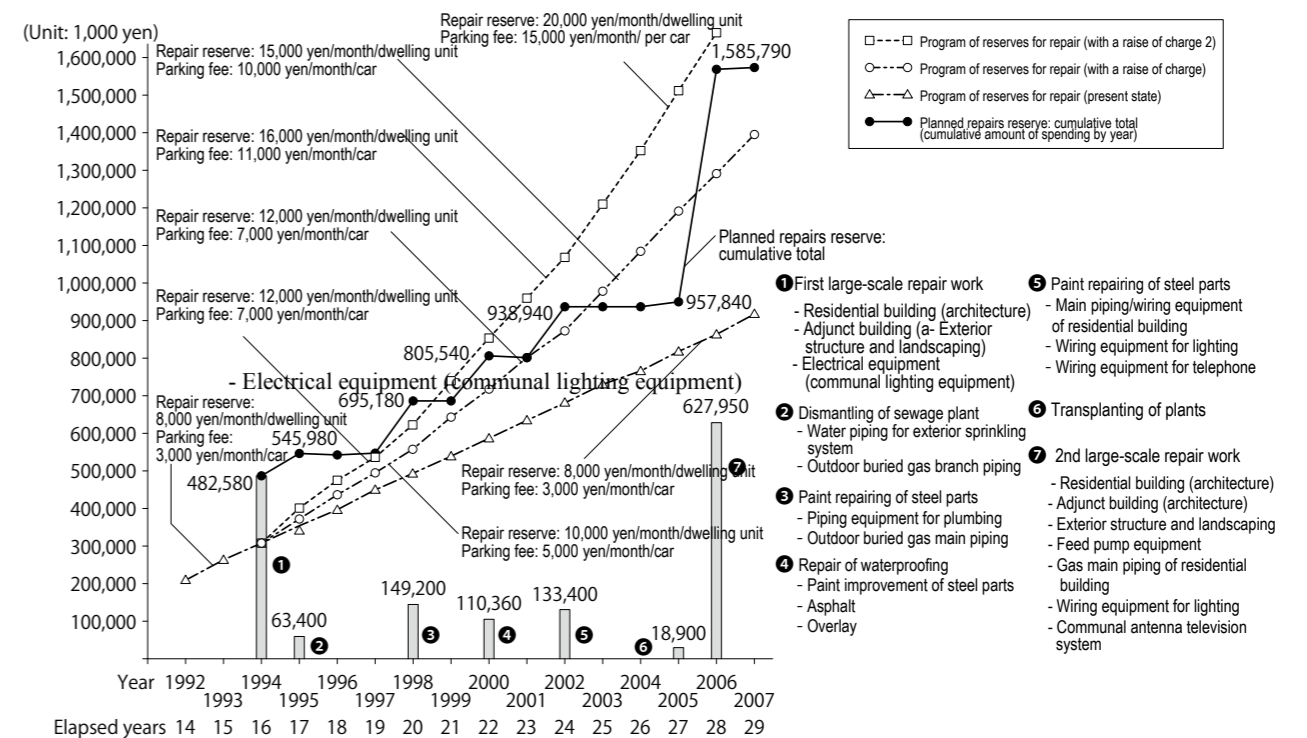

Figure 1. An example of a long-term repair program for condominiums1)

## 11-5 Maintenance and renewal

The wasteful days of “scrap and build” construction are now shifting to the years of appreciation of “stock.” Maintenance, along with repair and improvement of a building start at the completion of construction.

Today, systems for creating a sustainable society through careful maintenance and renewal of buildings for hundreds of years are desired.

### Maintenance of buildings

A building will be used for a long period and the maintenance starts at the completion of construction.

Well-maintained buildings will become more and more regal over time, with a feel of increasing history and character. Buildings made with great care and effort by their builders will become imbued with atmosphere as time goes by.

Traditional maintenance systems or methods had been established for temples in the Tenpyo or Asuka Period, some 1300 years ago, or many hundreds of years ago for traditionally built townhouses.

In contrast, contemporary buildings often prefabricated and constructed of chemical products such as plastics, and industrialized components of steel and aluminum, are more preoccupied with mechanization and the rationalization of construction works and have no established maintenance system.

### Maintenance system until the modern age

Until the Meiji and Taisho Periods (1868-1926) and before World War II buildings were designed and built by master carpenters and workers, and were also maintained by workers after completion. The residents cleaned their homes on a daily basis as well as carrying out a thorough clean of the whole building at the Bon festival and the end of the year, and therefore the buildings were well maintained. Many master craftsmen such as carpenters, joiners, and tatami makers earned part of their income from the maintenance of buildings. In this way, a durability of hundreds of years has been ensured in folk houses with a central pillar and urban mansions, as well as in reinforced concrete buildings more than 100 years old.

### Production of contemporary buildings and abandonment of maintenance

Although the foundations and building frames of contemporary buildings are manufactured, assembled, and constructed on site, non-structural elements such as sashes, equipment instruments, piping materials, etc. are manufactured in factories and installed into building frames as building components.

In the case of steel structure buildings and precast reinforced concrete structure buildings, only the foundations are constructed on site, and most building frames are manufactured in an ironworks or precast concrete works and assembled on site.

This kind of building production method has progressed in the direction of minimizing manual work by on-site workers and increasing the assembly of factory manufactured parts. Manufacturers of non-structural elements and equipment instruments showed little interest in the maintenance of parts and elements they manufactured, and focused on the development of new products and increasing sales.

Until the end of the 20th century, the construction industry of Japan has enthusiastically engaged in repeated “scrap and build” construction, or the demolition or reconstruction of existing buildings.

### Maintenance system of condominiums

Designers, as well as the workers or engineers of contractors, subcontractors, or manufacturers have not been involved in maintenance after the completion of a building, and their services after completion have been limited to claim management and studies for new product development.

Users or residents of buildings have had to look after the maintenance of their building by themselves, and gradually public distrust against developers, contractors, manufacturers, and architectural design offices has developed.

In response and mainly among the management associations of condominiums and housing complexes, the exchanging of experience and joint learning on maintenance have made good progress, and maintenance systems including inspection, cleaning, ordinary repair and planned repair have all been established (Figure 1). This kind of methodical system is essential to maintain buildings in the long term. Each item is discussed below.

#### 1. Inspection

Inspections by experts and legally prescribed inspections as legal obligations are being implemented. When defects are found in the inspection, the causes are studied, and the defect is handled as an ordinary repair, or is integrated as a planned repair.

#### 2. Cleaning

Cleaning is implemented to maintain the beauty of buildings and to create a clean environment. It includes the following works.

- i. Periodic cleaning of the interior and exterior of the building
- ii. Periodic cleansing and cleaning of waste water pipes, ventilation ducts, etc.
- iii. Periodic cleaning of reservoirs and elevated water tanks

These works are usually outsourced to professional cleaning companies. In addition, the residents themselves clean around their own dwelling unit. In some cases, they get together to do some building related activities, such as holding a Weeding Day or a Cleaning Day.

Moreover, the following cleaning works are implemented by being included in a planned repair because they are more effective when carried out using scaffolding.

- i. Cleaning of the inside of ducts, fire dampers, and vent caps
- ii. Cleansing and cleaning of exterior tiles and stone panels
- iii. Prevention of spot rusting and cleaning of sashes, balustrades and window gratings made of stainless steel or aluminum

#### 3. Ordinary repair

Ordinary repair means those works covered by a relatively small amount of expense, such as treatment of unusual deterioration or defects found in inspections or cleaning, repair or emergency treatment of damage caused by storm, flood, or an accident, and small repairs that require restoration.

#### 4. Planned repair

Finishing materials, waterproof materials, non-structural elements, plumbing systems, electric systems, etc. that will de-

teriorate over time should be periodically repaired according to the program.

Planned repair means works for continuously keeping the state of the building as at the time of completion and securing the safety of the building. Planned repair is usually implemented every 12 to 15 years depending on the degree of deterioration of the building elements.

#### 5. Repair and improvement

Restoring the status quo of the building is referred to as repair. In contrast, increasing a performance from the status quo of the building is classified as improvement.

### From repair to improvement

Under planned repair, repairs are planned and designed based on a deterioration diagnosis, and repair work is implemented. The wider the range of repairs, the more the construction cost will be. It is more economical in the long term to carry out elements and items of repair intensively at the time of the planned repair scheduled for every 12 to 15 years.

Some 40 to 50 years after completion, or at least after 2 or 3 planned repairs, the building will not be as livable in for residents, and their lifestyle will be quite different from today. It will become unreasonable to maintain the building in the same state as at the time of completion, and some improvement and upgrading will be required. This is called a renewal (Figure 2).

### Improvement and large-scale repair/remodeling

The improvement and upgrading requirements of old buildings vary, and policies for renewal range widely. For example, the following improvement and upgrading are recommended, and grants and subsidies are provided.

1. Improvement of heat insulation and energy conservation
2. Improvement of barrier-free
3. Seismic diagnosis and seismic retrofit

Those buildings some decades old, may be described as “existing non-conformed buildings,” and although basically they do not have to follow any law established or amended after their completion, such as the Building Standard Law of Japan, any “large-scale repair of more than one section of the building frames” or a “remodeling,” requires an application for building confirmation. In these cases, the building is required to “improve” and comply with existing laws. (Tetsu Miki)

#### References

- 1) Edited by the Japan Institute of Architects, Shin manshon hyakka (New Encyclopedia of Condominiums), Kajima Institute Publishing, 1999
- 2) Written and edited by the Committee on Building Maintenance, JIA, Manshon setsubi no kaishu (Improvement of Equipment for Condominiums)
- 3) Written and edited by the Committee on Building Maintenance, JIA, Manshon kaiso dokuhon (Refurbishing of Condominiums Reader)

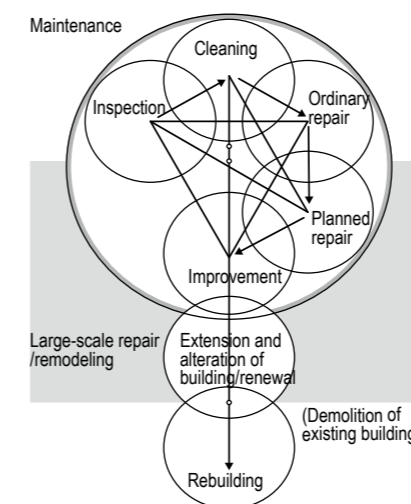
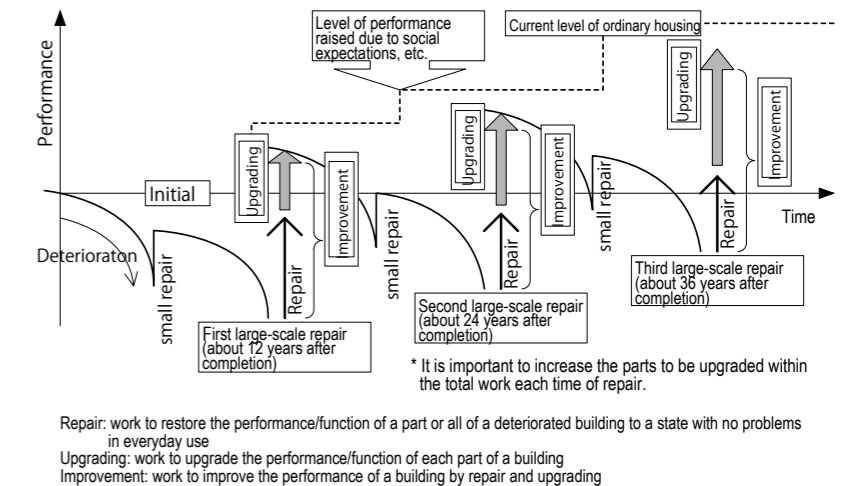

Figure 1. A conceptual diagram of maintenance, improvement, renewal, and rebuilding.



Repair: work to restore the performance/function of a part or all of a deteriorated building to a state with no problems in everyday use  
 Upgrading: work to upgrade the performance/function of each part of a building  
 Improvement: work to improve the performance of a building by repair and upgrading

Figure 2. A conceptual diagram of the deterioration of a condominium over time and the process from planned repair to improvements. The horizontal axis indicates time, and the upward direction of the vertical axis indicates increases of performance. Level of improvement: the downward direction indicates a decrease of performance.

## 11-6 Seismic diagnosis of existing buildings

At the time of the 1995 Hyogoken-Nanbu Earthquake, buildings designed based on the standards applied before the new standards established in 1981 suffered significant damage. Within the same year of the earthquake, the Act on Promotion of Seismic Retrofitting of Buildings was enacted; the purpose was to promote the seismic diagnosis and retrofitting of buildings that do not comply with the new standards of 1981. With an amendment in 2006, the range of specified buildings subject to the law was broadened and various subsidies and mitigation measures were newly included.

### Setting numerical goals of earthquake-proof conversion

The Act on Promotion of Seismic Retrofitting of Buildings revised in 2006 stated a goal to implement the improving/re-building of one million houses and 30,000 specified buildings in 10 years, as well as raising the target seismic conversion rate from 75% to 90% of existing buildings by 2015. In order to achieve these goals, the range of buildings subject to the seismic retrofit requirements was broadened (Figure 1). The revised law has also enabled local governments to give directions and to implement on-site inspections regarding diagnosis and retrofitting, as well as to make public the names of building owners who do not comply.

### Advantages of seismic retrofit certification

With the revision of the law, the following subsidy measures have been deployed.

Those buildings whose seismic diagnosis and seismic retrofit plans were examined and approved by competent governmental authorities or certification agencies and whose content was found to comply with the criteria of the Act on Promotion of Seismic Retrofitting of Buildings can enjoy the following advantages.

1. The building work is not required to apply for building confirmation even when it is subject to the application.
2. Except for seismic prescriptions, the regulations for existing non-conformed buildings and regulations related to fire resisting buildings are mitigated for those cases where it is inevitable that non-conformed items will remain.
3. Seismic retrofit work can be implemented in stages.
4. Seismic retrofit of a certified house can be covered by a low interest loan.
5. For specified buildings, 10% of their seismic retrofit construction costs are allowed as a special depreciation.

### Preparation and preliminary study

Issues concerning buildings designed based on old earthquake-resistant design methods as well as the process of seismic diagnosis are discussed below.

First, the existence of the following documents should be checked: as-built drawings and completion documents including a written application for building confirmation, a certificate of completion, and architectural and structural drawings. The as-built drawings and completion documents are essential to maintenance, seismic diagnosis, and strengthening of the building.

The process of a preliminary study is as follows.

1. An outline of the building is made, and checks are made on the information including the current and the original completion use zones, the building coverage ratio and the floor area ratio, and off-site shadow control. In addition checks to ascertain if any alterations were made to the building after completion, if the building is an "existing non-conforming building" or has any "non-conforming section," and if there is any item or factor that would present an obstacle to seismic retrofit design.
2. Explanations are given concerning the cost required for seismic diagnosis, the process from seismic retrofit planning and design to retrofit work, any grants and subsidies and so on.

### Building frame investigation for seismic diagnosis

Building frame investigation includes the following tasks.

1. Concrete cores with a diameter of about 100 mm and a length of about 150 mm are obtained from three positions of each story and their compressive strength and neutralization depth are tested.
2. Cracks in building frames and rebar exposure are visually inspected and recorded in the inspection drawing.
3. Levels of floors, etc. are measured, and settlements and inclinations are determined.
4. When the structural drawings of the building are unavailable or lost, positions, spacing, etc. of rebar in columns, bearing walls, beams, etc. are measured with a wall scanner, sections of concrete are chipped and the diameters, etc. of rebar in the building frame are checked, and structural drawings are restored.

### Building frame investigation of a steel building

The building frame investigation of a steel building includes the following tasks.

1. Checks for the inclusion of asbestos in any fire resistant covering; if asbestos is found to be present, special protective measures are required.
2. Inspection of welding of beam-column joints.
3. Verification of joints of column bases and the inspection of anchor bolts and base plates.

### Seismic diagnosis

In the seismic diagnosis of mid-rise reinforced concrete buildings and steel encased reinforced concrete buildings, a secondary diagnosis according to the standards of the Japan Building Disaster Prevention Association is implemented and the earthquake resistance of the building is calculated. For high-rise buildings, as well as buildings that do not fall under the range covered by the same diagnosis manual of the above association, a tertiary diagnosis and calculations are applied to the whole or a part of the building.

The value of seismic index specific to a building,  $I_s$ , is calculated by the formula shown in Figure 2.

Based on the results of seismic diagnosis, retrofit plans (one or two) are prepared as an indication of the degree of seismic retrofitting to be undertaken.

The results and the indications of a seismic retrofit are shown to the client, and while gathering the ideas and response of the residents, the direction of the retrofit plan and design are explored, and the work needed for the next step is proposed with an estimate.

The results of the diagnosis should be rated by a rating agency.

### Seismic diagnosis by an architect

Seismic diagnosis by an architect includes the following tasks.

1. Check the width of the road adjacent to the site, check if the road is designated as the emergency transportation route, determine if the building is "a building that may block the road when it collapses" by drawing a diagonal line of 45 degrees from the center of the road in the elevation drawing, and determine if it is "a building that requires guidance and advice for seismic conversion."
2. Check and examine the hazard map of the area and show it to the client.
3. Examine evacuation routes including balconies, width of passages and stairs, treads and rises of stairs, etc., and evaluate the safety of evacuation at the time of an earthquake.
4. Diagnose the earthquake resistance (proper placement of retaining walls) of objects such as concrete-block walls and vending machines that may block evacuation by overturning, as well as inspect fixing methods.
5. Examine the danger of collapse or a landslide involving retaining walls and cliffs with a height of more than 2 m by checking the presence or absence of damage or deformation and any positions of backing gravel and drain holes for backside drainage.
6. Examine fixing methods, positions, and the degree of corrosion and wear of any objects that are prone to fall off at the time of an earthquake, such as roof coverings, signboards, advertising pillars, and chimneys.
7. Assess the likelihood of the dropping off of non-structural elements such as glass and sashes, metal balustrades, and ALC panels. Assess defects in the swing of metal fixtures due to deformation, the effective width as well as damage and dropping off of expansion joints, and interfacial peeling due to the uplift of finishing materials such as mortar and tiles.
8. Check for the presence or absence as well as the degree of seismic strengthening of backings for ceiling finish materials of large spaces such as gymnasiums and auditoriums, which are prone to fall off during an earthquake.

### Seismic diagnosis by a facility engineer

1. The facility engineer should examine and evaluate setting and fixing methods of equipment instruments, including elevated water tanks, elevators, cooling towers, cubicles, hot water storage type water heaters, as well as the state of flexible piping at expansion joint parts.
2. Inspect disaster prevention equipment including fire alarm devices, sprinklers, and fire extinguishing systems, and propose improvements when problems are found.
3. Give advice regarding the function maintenance of equipment instruments and securement of utilities after an earthquake.
4. Regarding elevator equipment, check earthquake proof countermeasures including earthquake sensing systems for stopping at the nearest floor at the time of an earthquake, and the setting of stoppers for preventing any derailment of cables or counterweights.

### Comprehensive seismic diagnosis and strengthening plans

Seismic diagnosis should not be carried out solely by structural engineers, but should be done in a comprehensive way in cooperation with architects and facility engineers.

Some structural engineers have limited opportunities to directly consult with clients or lack the ability to communicate effectively with clients. An architect's ability to co-ordinate is essential to ensure the smooth progress of a seismic diagnosis and strengthening plan. Today, the repair and improvement of existing buildings are becoming major architectural design works, and therefore architects should acquire the ability to comprehensively co-ordinate seismic diagnosis and strengthening by working closely with structural engineers. (Tetsu Miki)

- Buildings subject to guidance and advice for earthquake-proof conversion
- Buildings with the following scale and use are subject to guidance and advice for earthquake-proof conversion.
- Kindergartens and nursery schools of 2 stories (ground and 1st floor) with an area of 500 m<sup>2</sup> or more
  - Elementary and junior high schools, etc. of 2 stories (ground and 1st floor) with an area of 1,000 m<sup>2</sup> or more
  - Nursing homes, etc. of 2 stories (ground and 1st floor) with an area of 1,000 m<sup>2</sup> or more
  - Buildings for storage/handling of hazardous materials
  - General gymnasiums with an area of 1,000 m<sup>2</sup> or more
  - Hospitals, theaters, department stores, etc. which are used by the general public of 3 stories (ground, 1st and 2nd floor) with an area of 1,000 m<sup>2</sup> or more
  - Buildings that are likely to block a road
- Buildings subject to direction and on-site inspection
- The following specified buildings are subject to the direction for earthquake-proof conversion and on-site inspection.
- Kindergartens and nursery schools of 2 stories (ground and 1st floor) with an area of 750 m<sup>2</sup> or more
  - Elementary and junior high schools, etc. of 2 stories (ground and 1st floor) with an area of 1,500 m<sup>2</sup> or more
  - Nursing homes, etc. of 2 stories (ground and 1st floor) with an area of 2,000 m<sup>2</sup> or more
  - Buildings for storage/handling of hazardous materials with an area of 500 m<sup>2</sup> or more
  - General gymnasiums with an area of 2,000 m<sup>2</sup> or more
  - Hospitals, theaters, department stores, etc. which are used by the general public of 3 stories (ground, 1st and 2nd floor) with an area of 2,000 m<sup>2</sup> or more

Figure 1. Buildings subject to earthquake-proof conversion

- In seismic diagnosis, the value of  $I_s$  (seismic index specific to a building) is calculated.
- $$I_s = E_o \times S_o \times T$$
- $E_o = C$  (strength index)  $\times F$  (ductility index)  
 $I_s$  = structural seismic index  
 $E_o$  = basic seismic capacity index  
 $S_o$  = shape index  
 $T$  = time index

Figure 2. Actual seismic diagnosis

## 11-7 Seismic strengthening of existing buildings

Seismic strengthening plans and design are implemented based on the results of seismic diagnosis. When the value of  $I_s$  is relatively high, minor strengthening is required, and when the value is low, major strengthening is required. Because buildings subject to seismic diagnosis were completed more than 30 years ago, building equipment, non-structural elements, etc. have often deteriorated over time, and they sometimes need seismic strengthening work in conjunction with planned repair and renewal.

### Strengthening plans vary depending on the value of $I_s$

From the seismic diagnosis results, several key aspects are extracted; the points considered include how weak is the building, what are its weaknesses, and which part of the building will break first when seismic force is applied. Based on these results, a strengthening plan of the building is drawn up.

### Strengthening plan when the value of $I_s$ is high

When a relatively high value of  $I_s$ , such as near 0.6, is obtained as a result of seismic diagnosis, a minor strengthening plan is made. First, a draft plan is drawn up as a basis for comprehensive discussions among the architect, structural engineer and facility engineer concerning the earthquake resistance, usability, construction cost and period and so on; after these discussions a plan is proposed to the client.

The following strengthening methods are often adopted.

#### 1. Improvement of extremely short columns

A column whose height is extremely short compared with the story height, is the result of a column with a spandrel wall on both sides, and is prone to suffer shear cracks at the time of an earthquake. Such extremely short columns can be improved by making gaps between the column and the spandrel walls by setting earthquake-resistance slits in the spandrel walls on both sides of the column.

#### 2. Improvement of pilotis

Columns without walls on lower stories are prone to collapse at the time of an earthquake. To solve this problem, walls should be installed into the beam-column structure planes in the same way as the upper stories.

#### 3. Strengthening of ductility

Lack of ductility in columns due to the wide spacing of hoops can be improved by wrapping the columns with carbon cloth or steel plates.

#### 4. Seismic strengthening of beam-column structure planes

This method strengthens the earthquake resistance of the building by installing shear walls or seismic braces into the beam-column structure planes which are necessary and effective to ensure the adequate balance of wall quantity of the building as a whole. Another method uses vibration dampers, instead of seismic braces, for controlling seismic motion.

#### 5. Seismic strengthening using outer-frame

Seismic frames are set on the outside of a building which does not have a two way escape at the time of a disaster such as a great earthquake. It not only increases the earthquake resistance of the building, but also provides an additional escape route by using the frame as an escape balcony.

### Strengthening plan when the value of $I_s$ is low

When a low value of  $I_s$  is obtained, an extensive strength-

ening plan is required.

In this case, it takes time to create a strengthening design. Therefore, it is recommended to sign up for a “strengthening plan” before starting a “strengthening design.”

The strengthening plan should include aspects of the following plans, and their characteristics, earthquake resistances, estimated construction costs, etc. should be examined by comparing a number of plans, and consensus should be obtained.

#### 1. Considerations concerning seismic strengthening

A draft strengthening plan to meet the value  $I_s$  of earthquake resistance performance goals should be drawn up, and considerations should be given as to whether the building is usable during the improvement work, as well as to what extent the usability of the building is reduced. It is also essential to give consideration to the costs of strengthening, construction periods, and whether the improvement can be implemented with continued use by the occupants.

#### 2. Considerations concerning rebuilding plans

Images of rebuilding should be created and construction costs should be roughly calculated. Sometimes, the scale and form of an existing building cannot be recreated due to alteration of the use zone, building coverage ratio, or floor area ratio as well as additional off-site shadow control. Recognition of these conditions should be shared with the client.

#### 3. Considerations concerning reduction plans

Removal of the upper stories of a building reduces the load and improves earthquake resistance. Consideration should be given to how many stories can be removed and to what extent seismic strengthening would be reduced.

#### 4. Considerations concerning seismic isolation retrofit

With this method, a seismically isolated layer is located in the basement, foundation, or mid-story of a building to reduce propagation of seismic motion to the building, and the seismic safety of the building is increased. It may increase earthquake resistance performances with little change in usability of the building because the strengthening requirement of the upper stories is reduced.

#### 5. Considerations concerning a step-by-step strengthening plan

This is the next best measure when any of rebuilding, reduction, seismic isolation, or seismic strengthening cannot be implemented. It is a step-by-step strengthening method involving increasing the earthquake resistance and the value of  $I_s$  in increments before a great earthquake occurs. In the hope that a giant earthquake will not occur before the building life ends, reasonable strengthening measures should be considered including implementing whatever can be done temporarily within the available budget, and when more funds are available, implement additional strengthening toward the goal of achieving the target value of  $I_s$ .

After considering the different strengthening plans mentioned above, the direction of the plan should be determined, and a contract for the seismic strengthening design drawn up.

### Target performances of seismic strengthening design

Target performances after strengthening should be set up. The target value of  $I_s$  varies depending on not just the building but also the needs of the client. The value of  $I_s$  should be 0.6 or more, and it should be 0.7 or more for school buildings which are designated as an evacuation facility at the time of

disaster.

There are different grades of earthquake resistance performance when a giant earthquake occurs, such as the minimum “protection of human lives,” “keep any damage to a level allowing restoration works to make the building reusable,” or “make the building able to continue being used even in the aftermath of an earthquake.” These are known as importance factors.

The target earthquake resistance performances of the improvement work should be explained to the client and agreement should be obtained.

### Structural strengthening and accompanying works

Columns, beams, or structural planes framed by columns and beams are strengthened. These structural elements do not exist independently but are related to such non-structural elements as sashes, piping and wiring for water supply and drainage, gas, electricity, etc., and interior and exterior finishing materials. Therefore, repair or improvement of the elements accompanying the strengthened building frames and/or alteration of piping and wiring are often required.

### Seismic strengthening and planned repair

Buildings subject to seismic strengthening were constructed before the new standards for earthquake resistant design of 1981, and now more than 30 years has passed since their completion. The building’s non-structural elements such as sashes and steel fittings as well as water supply, drainage and electrical equipment, etc. will have deteriorated over time and will soon require planned repairs and upgrading works.

Separate implementation of seismic strengthening and planned repair would require wasted investment in scaffolding work, etc. as well as ultimately result in inferior quality and standards. Therefore, it is better to prepare a comprehensive plan combining seismic strengthening and planned repair. And in such cases, deterioration diagnosis as well as repair plans and design of architecture and equipment will be required in addition to the strengthening plan.

### Seismic strengthening and renewal

Any planned renewal, that involves the “major repair or alteration of more than one kind of building frame,” change of use, or extension and structural alteration of building in conjunction with seismic strengthening, requires an application for building confirmation.

The cooperation of architects, facility engineers, and structural engineers experienced in improvement works is essential for planning and design combining seismic strengthening, planned repair and renewal. Large-scale repair or alteration work requires an application for building confirmation. On the other hand, strengthening work as defined by the Act on Promotion of Seismic Retrofitting of Buildings does not. The assessment of whether a certain degree of strengthening design requires an application for building confirmation, will often differ depending on building officials or certification agencies. Prior consultation is essential.

### Assessment or evaluation of strengthening design

When a strengthening design is completed, the structural strengthening is evaluated. Principally structural design is subject to the assessment of strengthening design.

Planning and designing of the renewal as well as an application for building confirmation are implemented by architects, and improvement design of the systems of water supply and drainage, air conditioning and ventilation, and electricity are implemented by facility engineers.

After the completion of works, a “mark of conformity” plaque indicating conformity to earthquake resistance standards may be displayed on the building (Figure 1).

### Strengthening planning and design and subsidies

There are subsidy schemes for diagnosis, and strengthening design and works. By effectively applying these schemes, buildings should be made ready for use over the long term.

The planning, design, and supervision of repairs and improvements require more effort, care and attention than the design of new constructions. The appropriate quantity of work can only be figured out with considerable experience.

(Tetsu Miki)



Figure 1. After the completion of strengthening works, an inspection plaque acting as a “mark of conformity” may be displayed to confirm the building meets earthquake resistance standards (by the Japan Building Disaster Prevention Association).

## 11-8 Architect's role in disasters

Emergency assessment of buildings for the prevention of secondary damage immediately after a disaster, or a housing damage accreditation survey for the support of reconstructing livelihoods, etc. all require the expertise of architects. By the time the building prescriptions of the Building Standard Law of Japan are lifted, architects are technically supporting proactive reconstruction works by the residents. Architects should carry out education activities in normal times to raise the awareness of disaster prevention in terms of self-help, mutual-aid and public assistance in cooperation with the community residents and public administration.

### Emergency assessment of buildings

Emergency assessment of buildings is the estimation of damage by visual inspection undertaken immediately after an earthquake to ascertain whether the building is likely to collapse in any aftershock, or whether there is any danger from fallen objects such as outdoor facility devices; the aim of the emergency assessment of buildings is to prevent any secondary disaster which may affect human lives (Figure 1). The inspection is classified into three categories: dangerous, requires care, and inspected. Different colored stickers are prominently displayed on the inspected building: a red sticker for a dangerous building, yellow for a building requiring care, and green for a safe inspected building. Any specific points are noted on an inspection sticker and attention drawn to them (Figure 2). It is important to provide information not only to the residents of the building but also neighborhood residents and passersby. Inspections by experts and specific recommendations and advice concerning risk avoidance often mitigate the uneasiness of residents affected by the disaster. The responsibility of architects is heavy; personnel to inspect and assess are collected by the local municipality.

### Housing damage accreditation survey concerning disasters

The "Procedural Guidelines of Accreditation Criteria for Houses Concerning Disasters" stipulate specific methods for surveys and inspections according to the loss ratio of houses prescribed in the "On Damage Accreditation Criteria Concerning Disasters (Notice by Cabinet Office, Government of Japan, 2001)." There are procedural guidelines for damage caused by earthquake, flood, and wind, and the extent of damage to houses is classified into 4 categories: total collapse, major collapse, partial collapse, and minor damage. Damage accreditation criteria are used to give a rough indication of information for a quick and accurate understanding of the present state of a disaster and the nature of any response, and also as criteria for damage surveys which will provide information for deciding support measures for the victims. A victim's certificate is used as information for making decisions on any application for benefits, lending, tax allowance, moratorium on utility charges, provision of temporary dwellings, etc. offered by the various support programs for disaster victims, including support programs for reconstructing the livelihoods of disaster victims; it is important to thoroughly understand the criteria. Basically damage surveys are implemented by the staffs of municipalities and fire departments. However, in the

case of large-scale disasters, organizations and bodies concerned with buildings are requested to offer support, and give recommendations by fulfilling the role of inspection experts (Figure 3). The aim of a quick survey is to simply evaluate the extent of damage, thus a building evaluated as "dangerous" in an emergency assessment of buildings is not necessarily classified as a "total collapse" or a "partial collapse." The results of emergency assessment of buildings are sometimes used as a reference in determining policies for a damage accreditation survey.

### Consultation of the victims

Consultation facilities for supporting the victims are set up in municipal offices and disaster refuges. In these facilities, victims can consult with architects with expertise concerning the safety of affected sites and houses, repair, rebuilding and emergency repair of houses, as well as benefits-related consultations and so on.

In the aftermath of the Great East Japan Earthquake, architects provided extensive consultations to the evacuees affected by earthquake and tsunami damage and to those people living near the nuclear accident site. Architects worked in cooperation with members of other associations, with whom they had cooperated with on a routine basis, to offer their respective expertise.

### Living as an evacuee

Disaster victims are suddenly forced to live in a group. From children to the elderly, many people will live in crowded conditions in a large space such as a gymnasium. They often have difficulty in acquiring the fundamentals for everyday life including diet and excretion. One person with a cold can easily affect the whole group. To ameliorate such stressful conditions, the one role that architects can play is to help maintain an orderly communal life by designing space creation that can provide small individual spaces to ensure temporary and simple privacy, as well as to prevent feelings of isolation in such large impersonal spaces as gymnasiums. Even in an emergency, these apparently superficial improvements to the quality of life have been found to have a very positive effect.

### Temporary housing

The Disaster Relief Act prescribes the standards for temporary housing. At the time of the Great Hanshin-Awaji Earthquake, many elderly people living alone were accommodated in temporary housing, resulting in many "solitary deaths." Efforts have been made to remedy the problems concerning the living conditions of temporary housing, including the lack of thermal performance of roofs, exterior walls, and separation walls, as well as a lack of usability for the elderly, the physically handicapped, and large families. Under limited budgets and given conditions, in order to improve the quality of daily life as much as possible, efforts have been made to build temporary houses utilizing local resources, and also by taking into consideration the possibility of longer or more permanent use. Architects have addressed a comprehensive coordination package of measures including preparing a layout plan of the whole site of temporary housing, promotion of employment of the evacuees, and providing ideas for locally produced and consumed resources, including use of local technology and local materials (Figures 4 and 5).

### Reconstruction from disaster

About 3 months after the occurrence of a disaster, reconstruction programs move into full swing. A variety of reconstruction plans may be implemented depending on the extent of damage, and the skills and experience of architects are required for new community developments including coordination of land use and large-scale urban improvement projects such as land readjustment projects. They consider not only public buildings but also houses considered as new "public sphere" for the reconstruction of local communities, and contribute to the reconstruction by providing technical aid for rebuilding and improvements. The government has prepared the following basic policies of reconstruction based on the Basic Act on Reconstruction in Response to the Great East Japan Earthquake, because the earthquake was a complex and extensive giant disaster.

1. Promotion of disaster-resistant regional developments
2. Livelihood regeneration of local communities
3. Regeneration of local economic activities
4. National development with due consideration of lessons from the earthquake

The Japan Institute of Architects Tohoku Chapter has started up town cafes including "Ishinomaki machi-cafe" and "Yuriage machi cafe" as spaces for the community residents to gather and discuss community developments.

Recognizing the importance of continuously preserving

the memories of cities and towns, architects have responded to improving earthquake resistance, as well as utilizing and regenerating architecturally and culturally important buildings. In the aftermath of the 2007 Noto Earthquake, many architects worked cooperatively for the reconstruction of the whole Kuroshima district, and as a result, the district was designated as a preservation district of historic buildings.

### Preparedness against disasters

The fundamental concept of disaster control measures is self-help by people on a routine basis. Not only preparedness against disaster, including improvement of fire resistance and earthquake resistance, as well as prevention of furniture overturning and utilization of earthquake insurance, but also educational activities to increase people's awareness of disasters as an event they may have to face in their lifetime. Preliminary reconstruction is aiming at enhancing people's awareness of disasters through imaging community developments for reconstruction after a disaster. Architects should cooperate in the preparation of manuals and simulation training for disaster reconstruction that is cooperatively implemented by public administration and citizens. Moreover, architecture-related associations should prepare a business continuity plan (BCP) to minimize the effects on their support activities when they too have suffered damage and disruption in the disaster.

(Sadako Koriyama)



Figure 1. A group of inspectors



Figure 2. A house classified as "requires care" after tsunami damage



Figure 3. An architect and city staff working on a survey



Figure 4. Wooden temporary houses using local materials (photo: Akira Otomo, The Japan Institute of Architects Tohoku Chapter)

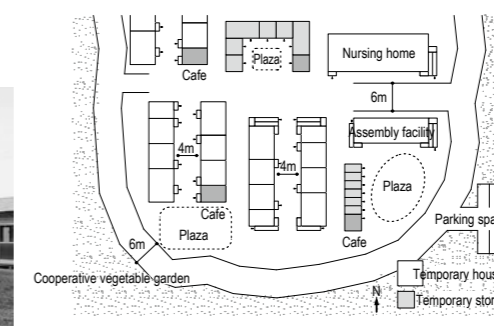

Figure 5. A layout scheme of temporary housing



Figure 6. Workshop for those residents who moved as a group (photo: same as left)

## 11-9 Earthquake insurance and architect's liability policy

Earthquake insurance mitigates the risks owners of buildings face from earthquakes. It is an important insurance and is effective, though its take-up rate is low. The architect's liability policy does cover the risks faced by architects; even though it is not compulsory, it is an essential insurance for the profession.

### Background and system of earthquake insurance

Earthquake insurance first came into existence in Japan with the passing of the 1966 Act on Earthquake Insurance. Before that time, including as far back as the devastating 1923 Great Kanto Earthquake, damage caused by an earthquake was not covered by fire insurance due to the "prescription exempting damage caused by earthquake, eruption, and tsunami." With the 1964 Niigata Earthquake, earthquake insurance was established based on the determination and ideas of the then Minister of Finance, Kakuei Tanaka.

In the system of earthquake insurance, earthquake insurance companies purchase whole reinsurance from Japan Earthquake Reinsurance. Japan Earthquake Reinsurance holds partial retrocession, and also purchases partial retrocession from non-life insurance companies as well as from the Government of Japan. With this system, when a giant earthquake occurs in Japan, damage is compensated without jeopardizing the management of any non-life insurance company. At the time of the Great Hanshin-Awaji Earthquake, actual payments totaled 77.8 billion yen, and for the Great East Japan Earthquake, it reached 1.2 trillion yen.

### Items covered by compensation from earthquake insurance

The system of earthquake insurance aims to secure a stable life for the disaster victims and immediately provide the funds required for reconstructing their lives. Therefore, it compensates damage due to fire, destruction, burial on land, or washout caused by earthquake, eruption, and tsunami. The items covered by earthquake insurance compensation are "residential buildings and all home contents necessary for daily life that are accommodated in a residential building." The term residential building includes dwellings with a shop, but does not include factory, office, store, warehouse, etc. The home contents necessary for daily life do not include automobiles, precious metals, securities, etc.

Moreover, the only items for compensation concerning the building are the main building elements (building frame, foundations, roof, exterior walls, etc.), but interior finishing materials, equipment, gates, fences, etc. are excluded.

### Premiums for earthquake insurance

Earthquake insurance is not an independent insurance. It is purchased as an accessory of fire insurance. The insurance premium varies depending on the structure of a buildings and its location. The premium for non-wooden buildings is about half that for wooden buildings. At present, those locations where urban near field earthquakes, as well as Tokai and Tonankai earthquakes are predicted, including Chiba, Tokyo, Kanagawa, Shizuoka, Aichi, Mie, and Wakayama prefectures, have premiums of about 3 times more than areas with a low earthquake risk.

In addition to tax incentives, premiums can be discounted; there are discounts for long-term contracts of 2 to 5 years, completion year (completion of new construction after June 1, 1981), seismic grade, seismically isolated buildings, seismic diagnosis, etc. Preferential treatment of earthquake resistant buildings encourages the promotion of earthquake-proof conversion of existing buildings.

### Payment of insurance compensation

The insured value of earthquake damage is determined to be equivalent to between 30 to 50% of the fire insurance of the main contract. The upper limit is 50 million yen for the building and 10 million yen for home contents. Assessment of damage is conducted by an insurance adjuster, and in the aftermath of the Great East Japan Earthquake, there was a severe shortage of adjusters. When a building suffers damage in an earthquake, the actual amount of damage is not accurately calculated and paid; instead, damage is assessed and classified as total damage, partial damage, or minor damage, and 100%, 50%, and 5% of the insured value are paid respectively (Figure 1).

If the total insured value of all non-life insurance companies at one earthquake exceeds the limit of 6.2 trillion yen, each amount of insurance payout may be reduced in proportion of the ratio of the total insured value to 6.2 trillion yen (the limit is as of July 2012). To the extent of the limit, the payment is secured by the Government.

It is said that the limit is set to prevent the total insured value exceeding the limit, even for an earthquake of the equivalent amount of physical damage of the 1923 Great Kanto Earthquake.

### Issues concerning earthquake insurance

The items subject to compensation from building earthquake insurance are limited to the main building elements such as the building frame, foundations, roof, and exterior walls; damage to non-structural elements and equipment are excluded. Damage in the common space of a condominium, such as balconies, corridors, elevated water tanks, and water supply equipment are excluded. After the Great East Japan Earthquake, damage to building parts other than the main building elements, caused by subsidence of ground settlement due to liquefaction, such as damage to the service mains for equipment, outdoor facilities, and parking areas, was not covered. Although such cover was stated in the insurance conditions, it was unexpected treatment and caused dissatisfaction among policyholders. Moreover, the assessment classification of just 3 categories: total damage (damage rate of 50% or more), partial damage (damage rate of 20% or more and less than 50%), and minor damage (damage rate of 3% or more and less than 20%), resulted in a great difference in the potential payments of 100%, 50%, or 5%, also caused much dissatisfaction. A 1% difference in the assessment of the damage rate could result in a 10 fold difference in the compensation payment.

To extend cover to additional items would require an increase of premiums. The abolition of fixed rate compensation would certainly slow down the speed of compensation settlement. Although there are problems with the present system, what is of paramount importance is to further improve the earthquake insurance system and to make it more effective in providing aid for disaster victims and promoting earthquake-proof conversion.

### Architect's liability policy

An architect's liability policy (kenbai) provides insurance to cover compensation for damage due to defects in practice such as design, which includes making design drawings and documents, instructions to contractors, and approval work for working drawings, all carried out within Japan. Specific damages covered include the following (Figure 2).

1. Damage caused by physical destruction, or an accident which results in damage occurring in the building designed by the architect
2. Malfunction of building equipment
3. Injuries to third persons
4. Cost of law suit and expenditure on research into the cause of the accident
5. Infringement of privacy, freedom, or reputation
6. Error in verification of legal conformity

In addition, optional damages include the following.

1. Nonattainment of structural standards due to errors in structural design, etc.
2. Injuries to third persons during implementing building investigation services (seismic diagnosis, etc.)

3. Damage that occurred after retirement from practice  
Damage due to conscious intention, war, earthquake, eruption, or tsunami are not compensated.

The architect's liability policy is handled by professional organizations such as the Japan Institute of Architects, Japan Federation of Architects & Building Engineers Associations, and Japan Association of Architectural Firms. This is a mutual aid system to cover an architect's risks and allow the architect to concentrate on practice. It also allows the architect to fulfill their social responsibility to the client. It is similar to the liability policy of a medical doctor, lawyer, or accountant. With the amendment of the Act on Architects and Building Engineers in 2007, disclosure of the capacity of indemnity liability is now a legal obligation. The insurance premium varies depending on the size of the design and the supervision fee. Regardless of its size, every architect's office should purchase such a policy.

(Kazuo Adachi)

□Source of figures

- 1) Based on information from the website of the General Insurance Association of Japan
- 2) JIA Accident Examples of Architect's Liability Policy 2010

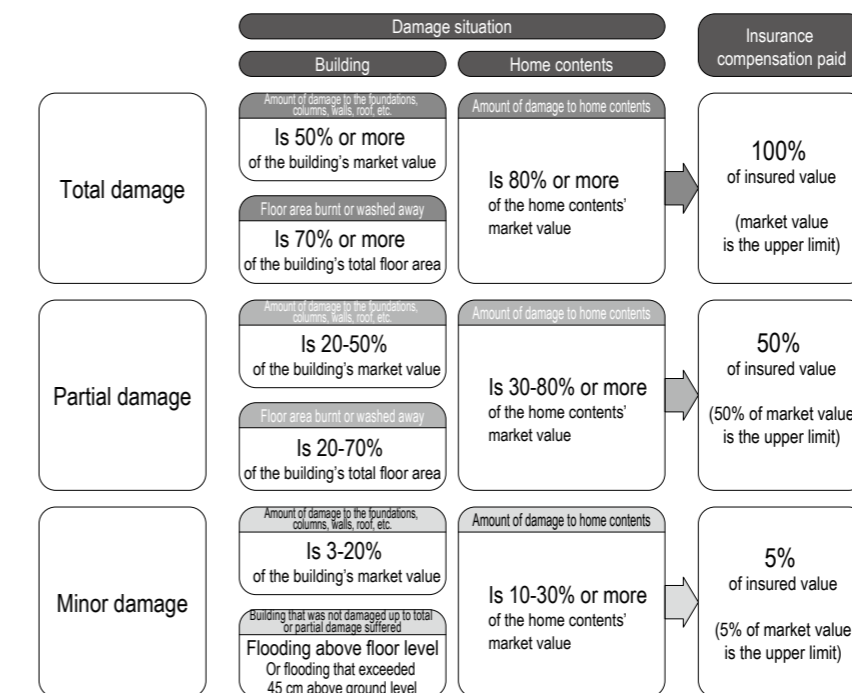

Note: For flood damage (\*) to wooden buildings (conventional post and beam structure, etc., wood frame construction) and steel buildings (excluding an apartment house) caused by tsunami, insurance compensation is paid as follows.

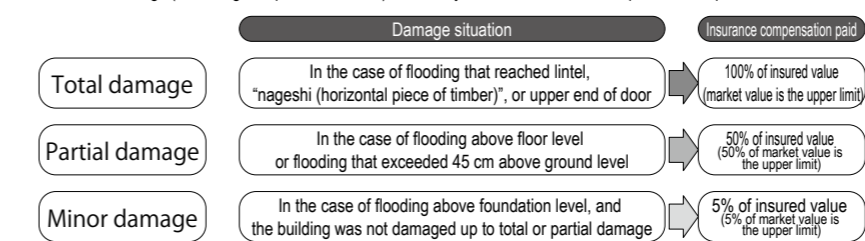

(\*) Applied only to flood damage caused by a tsunami

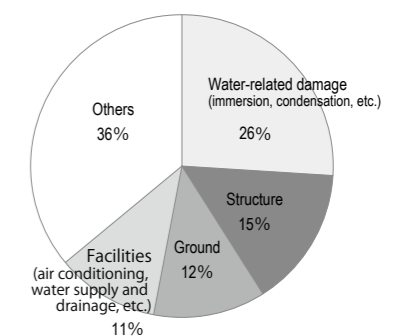

Figure 2. An analysis of payment for architect's liability policy<sup>2)</sup>

### 12-1 Leadership of the architect and teamwork

A building is constructed through the cooperation of many experts from diverse fields in response to the requirements of a client. At the same time, a building is an important social entity of any community. An architect bears the responsibility to coordinate the related fields in accordance with the accepted standards to ensure its social purpose, and from a comprehensive perspective integrate all the works for creating a particular construction.

#### Architecture as an ensemble of various fields

The winter of 2012 is the first winter after the Great East Japan Earthquake. Snow is falling lightly on a shadow town; a thin layer of snow reveals the foundation lines of houses that were once homes, and are now no more. Only a year ago, they stood in neat and ordered rows providing warmth and shelter for many people. Even in the Metropolitan area, elevators stopped, auditorium ceiling panels fell, and files on shelves crashed and scattered across floors. From such stories we learn that the earthquake resistance of building frames alone cannot ensure the safety of buildings, however big or small.

Modern architectures are created by a synthesis of diverse technologies drawn from many varied fields. Architecture is an achievement of many intellectual and mechanical efforts, and an architect bears the responsibility to coordinate them. The safety of a building is only ensured when a person with much knowledge concerning the fundamental concepts of earthquake-resistant engineering cooperates with a team of experts from many fields.

#### Building frames alone cannot ensure safety

In the aftermath of the Great Hanshin-Awaji Earthquake (1995), it was found that apartment buildings with well-balanced wall construction built by the Japanese Housing Corporation suffered little damage, even though they were built before 1951. In contrast, many buildings with ill-balanced structures, although built following the new improved standards, suffered damage. Also, during the 2005 Fukuoka Earthquake, the stone panels of a 16 story condominium built to the new standards fell off into the entrance hall of the first (ground) floor, blocking an essential evacuation route. Moreover, every non-structural wall on the lower eight stories, near to the middle of the building height, showed shear cracks, and entrance doors pushed by the cracked walls suffered out-of-plane deformation. On stories above the 7th floor, household goods thrown from shelves scattered and shattered across the floors leaving no place to stand. (Figures 1 to 6). Despite these interior events, the external appearance showed little sign of damage.

#### Role of architects

Today, buildings are designed using a wide array of technology and myriad calculations taken from a variety of fields; specifically, an architect works with a team of experts drawn from many disciplines. The team forms around the architect, and may cover as many as eight areas of expertise, including structural and facility engineers, interior coordinators, lighting and sound technicians, landscape designers, and sometimes urban planners and redevelopment coordinators.

The architect integrates the whole architecture during the

creation of the cooperative design works drawn up by the team. The architect proposes the basic concepts concerning spaces, and coordinates architectural spaces based on the client's desires. In the next step, the architect calculates budgets by each area, and as a primary design creates spaces by integrating building frames and equipment in accordance with the budget. When the client approves the primary design, working drawings are started.

In the working drawings stage, the architect organizes architectural areas and their proximity to equipment, etc., determines the materials to make up spaces, determines details to realize the spaces, calculates the costs for each area and keeps the total within the budget, and finally prepares working drawing documents (execution drawings, specifications, and itemized statements of costs). Based on these documents, the architect engages in the selection of contractor and the establishing of an organization for the construction stage, supervises whether the construction is following the working drawing documents, and inspects the completed building before handing it over to the client.

It is the architect's responsibility to keep an eye on the building after completion, ensure the client can use the building with no problems, and in the event of any defects, the architect cooperates with engineers, etc. to solve them.

#### Coordination skills

The building frame is important for ensuring the safety of the building and lies within the remit of the structural engineer. However, safety cannot be ensured by the building frame alone; ensuring the safety of non-structural elements such as finishes and equipment are equally as important. In addition, ensuring the comprehensive safety of a building requires not only tangible but also intangible measures in the form of systems and procedures. Therefore, an architect is required to integrate the whole of the architecture in terms of ensuring comprehensive safety in everyday living.

1. Architecture provides a place within which people live their lives, and is closely related to safety. The architect and the design team construct a building with other people's money, not their own.
2. Buildings require a great amount of resources. Architects are empowered to give direction to them. Through much consideration and many kinds of decisions a building is created.

These tasks require both comprehensive judgment, as well as the ability to coordinate many professional fields. The person who undertakes this duty is an architect.

#### Sharing remuneration according to practice

A building is a social entity, and is not a free entity; certain rules and restrictions are applied. A building becomes a reality by following a series of steps involving the accumulation of much consideration and many decisions within each step. Architects should consider themselves from a standpoint that allows them to decide without being unduly influenced by the opinions of others, and the remuneration they receive should be regarded as a compensation that guarantees the freedom of architects.

Guidelines for remuneration for architectural design are shown in guidelines issued by the Japanese government. However, the amount of remuneration actually received often greatly varies depending on ordering methods. An architect

who is regarded as a coordinator bears the responsibility to fairly distribute the remuneration among the many fields. A fair distribution will finally be determined by recognizing the kind and amount of work contributed by each participant, as well as by considering requests from each discipline.

(Junichi Nakata)



Figure 1. Wall finishes in the first story entrance hall fell off scattering rubble on the floor and blocking the designated evacuation route through the entrance hall.



Figure 2. Storage type water heaters, etc. placed on balconies were damaged by shaking and left leaning or out of alignment.



Figure 3. The expansion joint was damaged. The deformation of the balustrade shows signs of very severe shaking.



Figure 4. The entrance door has out-of-plane deformation, caused by cracked non-structural walls pushing on the door corners. The door can be forced open with a crowbar from outside, but it cannot be locked, leaving the premises insecure.

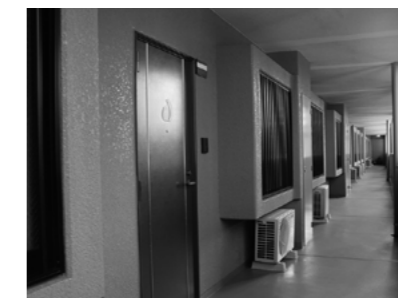

Figure 5. Shaking caused by seismic waves is in a certain direction. Any shakes perpendicular to the direction of intense shakes are weak, resulting in a small amount of damage.



Figure 6. This photograph shows interior damage on the 9th floor of a 16 story condominium; because damage to the lower stories produced a seismic isolation effect, shaking in the upper floors was amplified and home contents were scattered.

## 12-2 Architects, structural engineers and facility engineers

Many professionals in many fields engage in contemporary architecture, offering a wide range of services and skills from planning, construction supervision to completion of construction, and from maintenance, investigation and diagnosis through to repair and improvement design. It is especially important for architects, structural engineers and facility engineers to share knowledge concerning investigation and diagnosis as well as planning and design, and engage in free exchange of opinions and ideas as they collaborate on a project.

### Significance of the cooperation of professionals and coordinating skills

Many professionals of many different disciplines engage in contemporary architecture from planning to the completion of construction, and from maintenance to renewal and rebuild planning. An architect's talents and abilities to coordinate all these areas, as well as the unified vision and team work of engineers from the many fields needed to successfully plan and design a building are becoming increasingly important.

### Cooperation of architects and structural engineers

Buildings are frames to support the spaces within which people live their lives; they are shelters to create interior spaces; they are structures to propagate the gravity of the construction to the ground in a well-balanced way; and they are components that form our streets and cities. It seems that the fundamentals of being an architect involve planning spaces for lives, clearly representing structures and frames, and creating beautiful streets and buildings.

Architects develop a sense of balance and proportion to frame forms, and structural engineers give sound advice and properly verify these forms with structural calculations; it seems that this was once the primary relationship between architects and structural engineers.

### Issues in the Great East Japan Earthquake

In the aftermath of the Great East Japan Earthquake, much damage to recently-completed buildings appeared to be caused by a lack of sharing information between architectural and structural designers. The following items are examples of damage observed in Tokyo and Kanagawa, which were affected by shakes with a seismic coefficient of 4 or 5 during the Great East Japan Earthquake.

1. Finishing materials, such as tiles, around earthquake-resistance slits were broken and dropped off (Figure 1).
2. Expansion joint hardware, ceiling materials, balustrade walls, etc. were broken and dropped off (Figures 2 and 3).
3. Partition walls and fire doors with a backing of light gauge steel, as well as sashes of super high-rise condominiums were broken because they could not resist deformation. It often required more than 100 million yen per building to repair the damage (Figure 4).
4. Exfoliation of concrete occurred at beam-column joints, etc. of super high-rise condominiums with super high-strength concrete.
5. Ceiling materials in many high-rise office buildings and large halls dropped off.

It seems that these accidents were caused by a lack of sharing information concerning the results of building vi-

bration analysis assumed by structural engineers, as well as architectural details designed by architects for well-balanced settlement in response to fixation methods, and deformation of non-structural elements attached to building frames.

Medium and low storied low-tech buildings surrounding the latest buildings assessed by the Building Center of Japan suffered no damage. Although the Great East Japan Earthquake was a giant earthquake, there still remains a sense of distrust of super high-rise buildings that shake intensely and then require hundreds of millions of yen to be restored after every earthquake with a relatively low seismic coefficient of 4 or 5.

Such examples of earthquake damage to super high-rise buildings caused by the Great East Japan Earthquake should be strictly monitored. *(Tetsu Miki)*

### Facility engineers and architects and structural engineers

It soon becomes apparent that to maintain the functions of a building, the building frames and the maintenance of facilities are inseparable. Much the same is true of disaster prevention functions. At the time of disaster, any partial malfunction will make it difficult or impossible to protect the lives and property of the residents.

Although ideally building designers should acquire familiarity with all fields, practically in the case of sophisticated and complicated contemporary buildings it is close to impossible. Therefore, it seems inevitable that each field spirals into increasing specialization, focusing on ever smaller areas of expertise, as is seen in something as simple as building use with such splits as hospital or school, or the architectural profession itself dividing into design, structure, and facilities.

An aspect that raises concern is not so much the specialization by building use but that by profession. As mentioned above, specialization by profession inevitably continues as buildings become ever more sophisticated and complicated. As a result of such specialization, each expert narrows their interests and stops learning about other fields, and it often happens that a completed building, despite each specialist making their best efforts, is suboptimal and does not function completely as planned. After the Great Hanshin-Awaji Earthquake, many examples of such a lack of cooperation were evident. For example, many cases were seen where even though building frames suffered little or no damage, because a part of the building's facilities suffered great damage, the building was unusable for a time. Even important buildings that had been expected to act as disaster refuges and the like, lost functions across the whole building due to such circumstances as damage to the roof tank and the cooling tower, water loss accidents from sprinkler systems, or damage to receiving and transformer panels.

Such accidents are caused by either facility engineers not paying enough attention to the building use, or lacking knowledge concerning earthquake countermeasures. It is doubtful whether a facility engineer has sufficient expertise in both fields; one example of a simple knock-on effect is as follows: increasing the earthquake resistance of building frames means increasing the seismic force applied to the building, and this in turn requires a consequent increase in the strength of the earthquake resistance of facilities.

With the amendment of the Enforcement Order of the

Building Standard Law of Japan in 1981, the Guidelines on Earthquake-resistant Design and Construction of Building Equipment was published in 1982, and later revised in 2005.

In the guidelines, grade classification of earthquake resistant class S, A, and B, criteria for the selection of anchor bolts, and pipe joints were prescribed.

Facility engineers need to thoroughly consult with architects and structural engineers during the actual planning and design of buildings, share knowledge about the planning and design of buildings, and all of them must be willing to point out potential weaknesses and collaborate with each other to solve practical difficulties. In addition, facility engineers should ask for and take into consideration advice from architects and structural engineers regarding the above mentioned guidelines. *(Hiroshi Inao and Tetsu Miki)*

### Cooperation in the seismic diagnosis and retrofit of existing buildings

Cooperation among architects, structural engineers and facility engineers is also essential in seismic diagnosis and the seismic retrofit design of existing buildings. In addition,

teamwork is required involving experienced professionals with the ability to investigate and diagnose, as well as meet the different challenges found in the retrofit planning and design of existing buildings, as opposed to the skills needed for designing new buildings.

During the seismic diagnosis stage, a structural engineer implements a seismic diagnosis of the building frame, a facility engineer implements a seismic diagnosis of the equipment for water supply and drainage, air conditioning and ventilation, electricity and gas, and disaster prevention equipment, etc., and an architect implements a seismic diagnosis of the non-structural elements, evacuation routes, local disaster prevention, etc. as well as coordinates the whole execution of all these factors. For seismic diagnosis, structural engineers play the main role and architects and facility engineers support.

Seismic strengthening planning requires all three professions to contribute and explore the direction of planning. For minimal strengthening, structural engineers play the main role supported by architects and facility engineers. On the other hand, for large-scale improvement or renovation, architects play the main role in design. *(Tetsu Miki)*



Figure 1. Tiles around earthquake-resistance slits were broken and dropped off.



Figure 2. Ceiling materials at an expansion joint were broken and dropped off.



Figure 3. Balustrade wall at an expansion joint was broken.



Figure 4. Partition walls with backings of light gauge steel in the hallway of super high-rise condominiums were broken.



## 12-3 Role of structural engineers and facility engineers

A structural engineer, in cooperation with an architect, bears the responsibility to ensure the building frame lasts for many decades. A facility engineer, in cooperation with an architect, supports advanced building functions. Both bear consistent responsibility for the entirety of their own work. In 2006, the qualification systems for structural design first-class architects and facility design first-class architects were established, and both professions now bear greater responsibilities.

### Practices of structural engineers

A structural engineer, who in cooperation with an architect bears the responsibility of ensuring a sound building frame for many years to come, naturally bears consistent responsibility for the whole, and the role is becoming increasingly important. Public opinion strongly demands that a structural engineer provides an adequate consulting service in terms of engineering from the stage of programming and planning to completion, and later for the maintenance of the building.

#### 1. Classification of structural engineer's practice

The practices of structural planning, design and supervision are classified into the following categories, and these categories are further classified into 8 items.

- (1) Programming and planning
  - (i) Programming
  - (ii) Planning
- (2) Design
  - (iii) Primary design
  - (iv) Working drawings
- (3) Supervision
  - (v) Supervision of construction
- (4) Investigation and diagnosis, and planning and design of existing buildings
  - (vi) Investigation and diagnosis
  - (vii) Strengthening and improvement
  - (viii) Design and supervision of relocation and demolition

The practices of design and supervision are classified into "ordinary practice" and "special practice." Ordinary practice refers to the normal skills and techniques that structural engineer ordinarily implement. Special practice connotes a level of expertise that is not usually needed in everyday practice.

#### 2. Structural engineer's practices and deliverables

A structural engineer, in cooperation with technical specialists including an architect and a facility engineer, participates in the process of creating a building. The following are the structural engineer's responsibilities and deliverables.

- (1) Programming and planning
  - Structural plan documents
  - Geological survey plan documents
- (2) Primary design
  - Discussion with an architect about assumed sections, etc.
  - Estimated budget documents for structural construction costs
- (3) Working drawings
  - Structural calculation and preparation of calculation sheets
  - Dynamic analysis and preparation of analysis documents
  - Making structural drawings
  - Preparation of particular specifications of the structure

- Explanations given to competent authorities at the time of application for building confirmation

- Explanation in the case of applying for structural assessments

#### (4) Supervision of construction

Making shop drawings as well as inspections at different phases of the work including piling, bar arrangement, steel fabrication, and concrete placement.

#### 3. Complementary practices

Concerning consultations to architects and facility engineers, in addition to design, the following tasks are required to be carried out by structural engineers.

- (1) Selection of contractor for boring (soil investigation) and directions, and interpretation of investigation results.
- (2) Consulting on bearing capacity of soil, construction method of pile foundation, etc. based on the results of soil investigation.
- (3) Selection of ready-mixed concrete plant, and specific and detailed instructions on concrete placement. It is desirable to appoint an expert concrete consultant along with the structural engineer.
- (4) Selection of steel fabrication shop, and instructions on steel fabrication, assembly, welding, etc. It is also desirable to appoint an expert steel consultant.
- (5) Giving appropriate advice concerning the curtain walls, penthouse structures, non-structural elements, etc. best suited to the vibration characteristics of the building.
- (6) Giving advice to facility engineers concerning the installation of equipment instruments in all areas of the building from the basement to the penthouse. *(Hiroshi Inoue)*

### Qualifications for structural engineer

With the promulgation of the new Act on Architects and Building Engineers in 2006, two new qualifications were established: structural design first-class architect, and facility design first-class architect; previously there was no official qualification, and the only public qualification was "structural engineer" administered by the Japan Structural Consultants Association (JSCA). The law was amended after the scandals involving the fabrication of earthquake-resistant strength.

To obtain these new qualifications, 5 years or more experience in structural or facilities design practice as a first-class architect is required. Design of a building greater than a certain scale requires the involvement of professionals with these qualifications, as the structural or facilities designer or as an expert to provide verification of legal compliance. A building greater than a certain scale refers to "a wooden building with a building height of more than 13 m or eaves height of more than 9 m, a steel building with 4 or more stories excluding the basement, a RC or SRC building with a building height of more than 20 m, or other building specified by Cabinet Order." This system, including peer checking, started to be operated from May 2009. *(Kazuo Adachi)*

### Role and practice of facility engineers

The function and performance required for building facilities includes not only safety, security, and health, but also comfort, convenience, functionality, reliability, economic efficiency, and productivity. Moreover, a wide range of initiatives, including efficient use of resources, energy conservation, and reduction of the environmental load such as CO2 emissions, is

required; they should be applied to every level of the environment from single buildings to cities and the earth. Society expects facility engineers to be actively designing and installing systems that contribute to all these goals. Facility engineers are required to plan and design established performances, and engage in a variety of practices to apply their skills over the life cycle of a building, including the following items.

#### 1. Configuration of design conditions and designing as an embodiment of the given conditions

Facility engineers draw upon their expert skills and broad knowledge to clarify design conditions by reconfiguring the client's desires and requirements, and then based on these conditions design an appropriate solution.

#### 2. Ensuring performances and quality of design

The building performances that facility engineers are required to look after include comfort, reliability, maintainability, life extension and LCC (life cycle cost)/LCCO2 (life cycle CO2), and environmental protection and energy conservation. To realize them, facility engineers implement not only planning and design but also performance verification after completion (commissioning), LCM (life cycle management), comprehensive performance assessment of a building and so on.

#### 3. The construction of high-quality buildings through integration of design, structure and building facilities

The practice of architectural design is implemented by the differentiated professions of design, structure and facilities. However, a building is not viable with separate design works compiled by each professional field; it is only the integration of the skills of each professional, which will allow the construction of high-quality buildings.

Facility engineers deal with a wide range of areas including the environment, air conditioning, water supply, drainage and sanitation, electric systems, information and disaster prevention, and elevator machinery.

### Qualifications for a facility engineer

#### 1. Facility design first-class architect

With the recent shift toward high-rise, large-scale, and complex buildings incorporating advances in building technology, differentiation and specialization in the design fields has progressed, and the expertise of engineers has become increasingly fragmented. In response to these changes, a new qualification a "facility design first-class architect" who is involved with professional facility design practices was established and the system started operation from May 2009. Any building greater than a certain scale (3 or more stories and with a total floor area of 5,000 m2 or more) which includes advanced and complex building facilities requires involvement by facility design first-class architects.

The term "involvement" means design practices by a facility design first-class architect, or the verification of whether the building complies with the facility-related prescriptions shown in Table 1, that is, to verify legal compliance of the building. The prescriptions are limited to the range shown in the table.

#### 2. Building mechanical and electrical engineer

A building mechanical and electrical engineer is considered to have knowledge and skills of building facilities in general and is qualified to give a qualified architect appropriate advice on the design and supervision of advanced and complicated building facilities.

Paragraph 5, Article 20 of the Act on Architects and Building Engineers prescribes that when a qualified architect has consulted a building mechanical and electrical engineer about design or supervision regarding the facilities of a large-scale building or other building, in the course of carrying out such procedures as an application for building confirmation, the qualified architect should indicate accordingly in the design documents or construction supervision reports. *(Wataru Kuroda)*

Building Standard Law of Japan	Facility
Paragraph 3, Article 28 of the Building Standard Law of Japan	Ventilation equipment for a habitable room, etc. of specified buildings Ventilation equipment for a room where naked flames are used
Paragraph 3, Article 28-2 of the Building Standard Law of Japan(limited to the part regarding ventilation equipment)	Ventilation equipment regarding formaldehyde, etc.
Article 32 to Article 34 of the Building Standard Law of Japan	Electric equipment (Article 32) Lightning arrester equipment (Article 33) Elevator machinery (Article 34)
Article 35 of the Building Standard Law of Japan(limited to the part regarding extinguishment equipment including fire hydrants, sprinklers, reservoirs, etc., smoke exhaustion equipment and emergency lighting equipment)	Emergency lighting Smoke exhaustion equipment * Verification of legal compliance is excluded because the structural standards and any legal obligation to install extinguishing equipment are regulated by the Fire Service Act (the same applies to Article 36)
Article 36 of the Building Standard Law of Japan(limiting to the part regarding extinguishment equipment, lightning arrester equipment, installing and structure of piping equipment including water supply and drainage equipment, and structure of chimneys and elevator machinery)	Lightning arrester equipment Installing and structure of piping equipment including water supply and drainage equipment Chimney Elevator machinery

Table 1. Prescriptions regarding building facilities

# 13 Limitations of Urban Facilities and Self-sustaining Disaster Prevention Schemes

## 13-1 Limitations of urban infrastructure

The Great East Japan Earthquake caused extensive damage, and the amount, kind of damage and restoration to the urban infrastructure varied greatly. Furthermore, the nuclear accident had a considerable impact on the supply of electricity; it is clear that the energy supply structure of Japan, which depends on giant-scale urban infrastructure is facing a limit.

### Damage of the Great East Japan Earthquake and restoration

Figure 1 shows an outline of the damage of urban infrastructure caused by the Great East Japan Earthquake. The damage to water, electricity and gas supplies are described below.

#### 1. Water supply system

After the 1995 Great Hanshin-Awaji Earthquake, about 1.3 million dwellings had their water supplies cut, and after the Great East Japan Earthquake and aftershocks after April 7, 2011, about 2.3 million dwellings in 12 prefectures had no water supplies. The rate of restoration of water supplies was about 90% over a month, excluding the area where houses were washed away by the tsunami.

The seismic conversion rate of main piping (aqueducts, water mains, and distribution mains) of water supply systems in 3 prefectures in the Tohoku region was, 34.3% in Iwate, 30.3% in Miyagi, and 46.5% in Fukushima prefecture, and the seismic conversion rate in Ibaraki prefecture, where the number of houses with cut water supplies (about 670,000 dwellings) was largest at the time of the Great East Japan Earthquake, was 21.0% (as of the end of fiscal year 2008, survey by Ministry of Health, Labor and Welfare, the same hereafter). In the Metropolitan area, the seismic conversion rate is 61.5% in Kanagawa, 39.4% in Chiba, 29.9% in Saitama, and 29.5% in Tokyo. The seismic conversion rate of the main piping of water supply systems ranges widely from 4.5% to 61.5%. A low national average of 28.1%, only underlines the importance of promoting the seismic conversion of water supply systems in the future.

#### 2. Sewage system

Sewers suffered raised manhole covers and damage to roads due to liquefaction of back filling soil and also damage to reclaimed land in coastal areas. The number of municipalities with damaged sewage systems reached 135, and the total length of damaged sewers was some 1,000 km (Miyagi had the most with about 400 km). After the Great East Japan Earthquake, sewers damaged in past earthquakes and repaired according to new standards for back filling, including a compaction rate of 90% or more, suffered little damage. Immediately after the earthquake, 48 sewage treatment plants stopped operation due to seismic motion or the tsunami. Minami-Gamo Purification Center, which treats 70% of the sewage waste from the Sendai City area in Miyagi prefecture, was devastated by the tsunami, even so it resumed primary treatment (sedimentation and disinfection) on March 18, 2011. The sewage treatment center in Rikuzen-takata City of Iwate prefecture, which was overwhelmed by the tsunami along with the urban area, introduced unit-type membrane treatment units and resumed treatment on April 28, 2011 for the 400 surviving households. When sewage facilities suffer damage from a great earthquake and cannot provide basic domestic sanitation, this has a se-

rious effect on the lives of the residents. In addition, it can be the cause of secondary disasters including damage to public health by disease, and flood damage due to the retention or outflow of sewage water.

#### 3. Electricity supply network

After the Great Hanshin-Awaji Earthquake, about 2.6 million households experienced an immediate power blackout. Within 2 hours or so about one million had power restored, and emergency transmission of electricity was completed 6 days later. The Great East Japan Earthquake immediately cut electricity to about 4.5 million customers, a 78% blackout rate within the Tohoku Electric Power area, and about 4.05 million, a 14% blackout rate in the Tokyo Electric Power area. The primary concern of restoring any power outage of the electricity infrastructure is to ensure any repairs are absolutely safe, so as to prevent secondary disasters. Tokyo Electric Power completely restored power on March 19, and Tohoku Electric Power restored electricity to all surviving households on April 25 (excluding households whose safety was unconfirmed, or were located in a restricted area). Due to a flood caused by a tsunami with a height of 15 m above mean sea level, the Fukushima Daiichi Nuclear Power Station lost power and the reactor cooling function, resulting in a major nuclear accident. With the plant down, there was a severe shortage of power to the area served by Tokyo Electric Power. Therefore, rolling blackouts were implemented in order to prevent unpredictable blackouts on a regional scale, but even so this still led to an unprecedented degree of urban chaos. The whole affected area was divided into 5 divisions and electricity was cut for about 3 hours in turn; in addition, maximum electric power for use by commercial-scale customers in the summer season (from July 1 to September 22, 2011) was limited to 85% of the previous year. In response to this crisis, institutions and associations related to buildings recommended energy saving measures to the general public, and developed educational activities by preparing brochures of specific measures.

#### 4. City gas supply network

City gas is supplied by some 250 suppliers to about 29 million customers across the nation, and the penetration rate within the supplied area is about 80% (as of the end of FY2009). The Great East Japan Earthquake interrupted gas from 16 suppliers located in the Miyagi, Ibaraki, Fukushima, Iwate, Aomori, Chiba, and Kanagawa prefectures, and about 400,000 dwellings suffered interruption. A month or so later, restoration of supplies was completed (excluding Ishinomaki Gas); a shorter period than the 3 month complete recovery from the Great Hanshin-Awaji Earthquake which affected about 850,000 households. More than 75% of all dwellings affected were located in Sendai City, and no damage of medium-pressure gas conduit facility occurred. Some city gas plants did suffer damage from the tsunami and a complete interruption of supply was implemented. However, city gas was continuously supplied to important facilities with continuous/emergency use power generators using the remaining gas in gas holders and medium-pressure gas conduits. In addition, temporary gas supply facilities were introduced to important facilities such as hospitals.

### Limitations of urban infrastructure

The supply and treatment of water and energy in Japan are based on a giant-scale urban infrastructure including water

sources constructed in remote mountainous locations, sewage treatment plants located in river basins, as well as electric power plants and LNG receiving terminals in maritime areas. As so clearly demonstrated by the chaos seen immediately after the Great East Japan Earthquake caused by the nuclear accident power supply shortages, urban functions suffer extensive paralysis when urban infrastructure, located in areas vulnerable to earthquakes or tsunamis, suffer damage. A

single damaged water pipe from a dam can result in massive and prolonged interruption of water supplies. As the raised sewer manhole covers seen in Chiba City and Urayasu City of Chiba prefecture bear testimony, even such a simple thing as non-functioning toilets may greatly affect the lives and health of residents for some time (Figure 2). It is essential to prepare as much as possible against disasters with the minimum of reliance on a functioning urban infrastructure.

(Hiromasa Katsuragi)

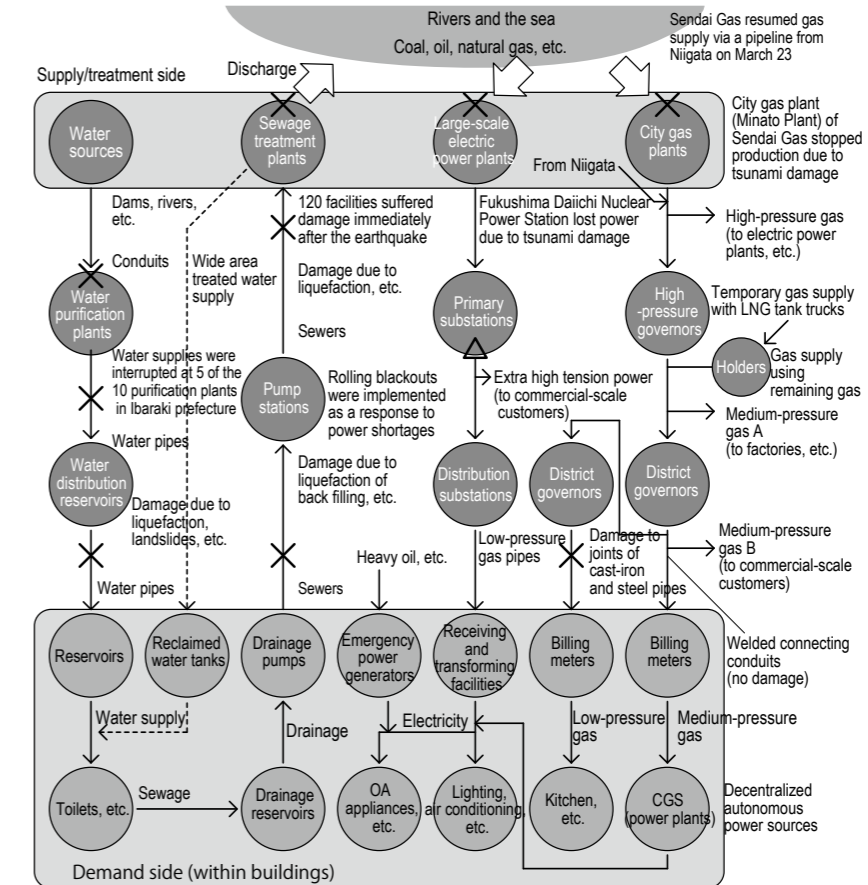

### 13-2 Infrastructure improvement ensuring compatibility between disaster prevention and the environment

With the advent of a smart grid, smart energy network, and Smart Community utilizing renewable energy such as sunlight, solar heat, geothermal heat, wind power, and hydraulic power, there are now more possibilities than ever before to implement resilient and durable disaster prevention functions.

#### Best mix of urban and decentralized infrastructure

The Great East Japan Earthquake nuclear accident dramatically underlined the vulnerability of any society which depends excessively on large-scale power supply networks, and has resulted in an increasing interest in decentralized autonomous power sources. Initiatives to respond to power conservation requirements due to power shortages immediately after the earthquake have led sophisticated companies to develop better risk management strategies such as business continuity planning (BCP). Not only the storing of supplies for disasters, but also ensuring an independent power source in preparation for disaster is needed. Ideally such a power source should be a combination of electric power, such as large-scale plants of thermal, hydroelectric, or nuclear power, and smaller power facilities utilizing renewable energy, such as sunlight and wind power, along with decentralized autonomous power sources, such as cogeneration, and batteries; by ensuring no over reliance on any one source such a system is expected to independently maintain building functions, even when energy supplies from the normal urban infrastructure is interrupted. Smart grid (next-generation transmission network) is defined as a transmission network that enables electric power flow to be controlled and optimized for both the supply and demand sides. It is an infrastructure for the highly-efficient and stable control of supply and demand of electric power, using information and telecommunication networks to connect the demand side such as office/commercial buildings and residences to power supply facilities.

In the summer of 2011 after the earthquake, there were serious power shortages and a variety of very successful measures to save and allocate power were introduced, such as the cutting of peak power usage by offices, and coordination operations at factories. These measures not only achieved successful energy conservation, but also made people realize just how excessive and wasteful their previous use had been. Smart grid supports such an optimization of energy use, and is an essential system for widespread utilization of renewable energy, such as solar power and wind power. The diversification of energy resources will increase Japan's response capability to disasters.

#### Utilization of locally-produced renewable energy

Simply known as renewable energy, sunlight/solar heat, geothermal heat, wind power, hydraulic power, snow-ice heat, biomass, wave power, etc. are inexhaustible nature-derived energy that can be almost permanently utilized for power generation, hot-water supply, air conditioning, and fuels, unlike the finite fossil fuels such as oil, coal, and natural gas (Figure 1).

The Bill on Special Measures Concerning New Energy Use by operators of electric utilities was enacted in August 2011 (scheduled to be enforced on July 1, 2012), aiming at promoting

the utilization of renewable energy; it is based on a system of purchasing the full amount of surplus electricity, and obliges electric power companies to buy the full amount of electricity produced from renewable energy resources such as solar power, wind power, geothermal power, and biomass for 15 to 20 years. The north-south Japanese archipelago with a slender shape, surrounded by warm and cold ocean currents, and mountainous and complex topographies, stretches across many climate zones. The potential amount of renewable energy varies by region, and it is desirable to plan to utilize locally-produced natural energy or renewable energy. There are issues concerning renewable energy, such as output power fluctuations arising from a dependence on climate considerably affecting the frequencies and voltages of power distribution systems. To address these issues, the New Energy and Industrial Technology Development Organization (NEDO) by developing a smart grid environment in the Kihei district in Maui, Hawaii has started an experimental study of a management system for coordinating the timing of charging electric vehicles.

#### Smart energy network

Smart energy networks which are being planned from the perspective of energy conservation in daily use and low-carbon community developments would also be effective in terms of disaster prevention. Smart energy networks combine decentralized autonomous on-site power sources (exhaust heat from power generation is effectively utilized in regional air conditioning facilities, etc.) consisting of highly-efficient large-scale cogeneration systems and system power supply from electric power plants. They provide optimized energy operations with an integrated management system that connects energy utilization equipment on the demand side (buildings) and smart energy centers (regional air conditioning facilities) on the supply side with energy supply networks and information and telecommunication networks, and also promote disaster-resistant low-carbon community developments. City gas, an energy source of decentralized autonomous power sources, is supplied via extensive and looped networks in metropolitan areas by Tokyo Gas, Osaka Gas, Toho Gas, etc. From LNG receiving terminals constructed in maritime areas, city gas is supplied via berths, tanks, gasification facilities, calorific value adjustment facilities, etc. The supply pressure of city gas is classified into 3 categories, high-pressure, medium-pressure, and low-pressure, and is stably controlled at pressure regulation facilities (governor stations). Medium-pressure gas piping connected with penetration welding is highly resistant to earthquakes and increases the reliability of decentralized autonomous power sources. Earthquake disaster prevention systems of gas companies have a function to encourage operators in supply command centers to make remote shutdowns, as well as a function to provide a forecast of building damage and liquefactions within 10 minutes after the occurrence of an earthquake.

#### Developments toward Smart Community

Smart Community is a new concept of a comfortable, safe, and convenient community that ensures optimization of all energy fields, by connecting smart meters, HEMS(1), and BEMS(2) to infrastructure suppliers and cloud computing, and providing transmission and reception of information on

energy for both the demand and supply sides. It also utilizes information technology to ensure the optimization of various environmental infrastructures which make up a city, including information and transportation infrastructures, water supply and sewage systems, recycling/waste treatment facilities, and green spaces/parks (Figure 2). The Ministry of Economy, Trade and Industry has selected 4 areas (Yokohama City, Toyota City, Kansai Science City and Kitakyushu City) as "Next-Generation Energy and Social System (Smart Community) Demonstration Areas." They will implement pilot demonstration projects in such fields as telecommunications, urban development, transportation systems, and lifestyle, centering on the field of energy. It is anticipated Smart Community will make a great contribution

to new urban infrastructures and should be effective in both energy conservation including demand controls and energy allocations, and disaster prevention. To realize Smart Communities, multi-layered cooperation of all industries is required and highly specific master plans tailored to the characteristics of each area are essential. In addition, functions to integrate individual systems as well as business frameworks with sound profitability are required to realize their success.

(Hiromasa Katsuragi)

- Notes
- (1)Home Energy Management System
- (2)Building Energy Management System



Figure 1. Solar water heaters meeting the demand for hot water

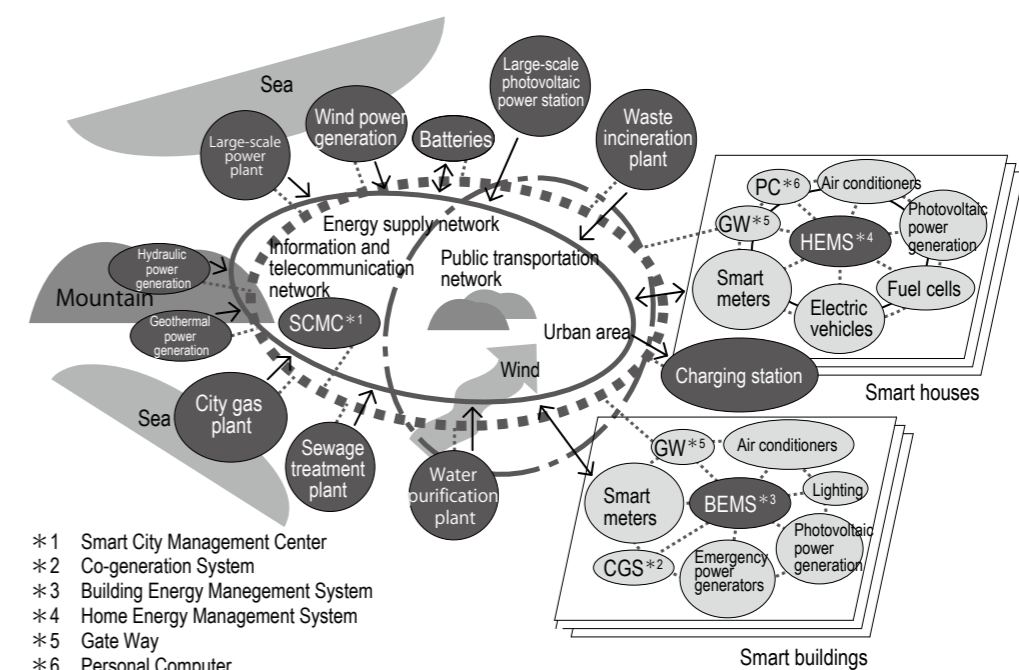

- \*1 Smart City Management Center
- \*2 Co-generation System
- \*3 Building Energy Management System
- \*4 Home Energy Management System
- \*5 Gate Way
- \*6 Personal Computer

Figure 2. Conceptual diagram of Smart Community

### 13-3 Ensuring self-sustaining functions

To maintain building functions after an earthquake, proper planning and preparation of any response is essential. The levels of power, air conditioning, and water supplies and drainage functions to be ensured should be clearly defined. Buildings which allow the use of natural energy require less energy and are more resistant to disasters.

#### Ensuring functions

It is important to calculate the levels of a building's functions to be ensured after a disaster, such as an earthquake, tsunami, fire, or liquefaction.

To estimate these levels, both goals and measures should be considered and calculated beforehand. Goals simply means the target functions to be ensured after the disaster. In response to the type and scale of the disaster the functions to be ensured must be clearly defined. Secondly, it should be clearly defined what measures should be undertaken in relation to these functions. Concepts concerning goals and measures are integrated into the function maintaining plan in its initial phase.

The everyday working of a building is dependent upon urban infrastructures such as electricity, gas, water, sewage, and telecommunication. The reliability of these infrastructures should be checked first, and in the event of their interruption, self-sustaining functions should be ensured.

To maintain the operability of a typical building, electricity, air conditioning, and water supply and drainage need to be ensured. Dividing response measures into the following 3 stages along a time axis will make planning easier.

- (1) Responses during/after the disaster
- (2) Short-term responses immediately after the disaster
- (3) Medium- to long-term responses to extensive disaster

In terms of (2) Short-term responses, in the case of key buildings such as government buildings and hospitals, the target period is several hours to 3 days after the occurrence of a disaster. In the case of headquarter functions of private companies, etc., the period will vary and cases should be decided on an individual basis (Figures 1 and 2).

#### Natural energy

Those facilities that effectively utilize natural energy, such as daylight, natural ventilation which reduces air conditioning, geothermal utilization, and wind power generation, can reduce energy needs and are more resistant to disasters. Measures to increase energy self-sufficiency and to reduce the energy burden also contribute to disaster countermeasures, and therefore they should be proactively considered.

#### Ensuring electric power sources

To ensure electric power sources, an emergency power generator should be provided. The fuel is supplied from a fuel tank installed near the generator. When a large volume of fuel needs to be stored due to the assumed operation hours, an underground storage tank should be used. Heavy oil or kerosene is the usual generator fuel, but it is important to select a fuel type which can easily be ensured from local supply depots and to also check the supply method. Generators are mostly engine or turbine types. When a cogeneration system is installed in a facility, the power generator of the system is sometimes also used as an emergency power generator. When earthquake-resistant gas piping is used, a gas-driven emergency power generator may be adopted. As technology advances, new methods including a combination of large battery systems and photovoltaic power generation, and fuel cells have been studied. Those facilities where electric power supply must never be interrupted, such as operation rooms

in hospitals and computer centers, should be equipped with UPS (uninterruptible power-supply system). Medium- to long-term responses should include setting connecting feeders which enable electric supply from temporary power sources from outside, such as power source cars, as well as planning to install dual service wires from different rolling blackout areas.

#### Ensuring air conditioning

In most cases, ensuring air conditioning means ensuring cooling. Heating can be provided with supplies. So it is important to establish clear goals. To operate machines such as air conditioners, pumps, and fans, electricity must be supplied. On that basis, heat-source equipment and air conditioners are selected.

When the space for air conditioning is small, an electric package air conditioner as an isolated system is often used. When a central heat source system is adopted to provide air conditioning for a large space, a part of the heat source equipment should be an electric type. As a short-term response,

thermal storage tanks may be used.

#### Ensuring water supply and drainage

Water supply usually should be ensured up to (2) Short-term responses.

After clearly defining the emergency water requirements for 3 days, consideration should be given to the capacity of any reservoir, the adoption of an earthquake-resistant reservoir, as well as the utilization of wells. In any event the power source for pumps should be an emergency power source. Rainwater or water in thermal storage tanks may be used as flush water for toilets, or if portable filtration equipment is available, used as drinkable water. Regarding (3) Medium- to long-term responses, measures should be taken to make reception of water from water wagons easier.

Temporary storage should be made ready with a drainage tank of sufficient capacity in case sewage water cannot be discharged due to liquefaction, etc. (Hiroshi Ida)

Responses at the occurrence of a disaster	Responses to an earthquake	<ul style="list-style-type: none"> <li>- Key sections broadcast, earthquake alert transmission system for staffs' cell-phones</li> <li>- Seismic-response controlled structure for continuing medical activities</li> <li>- Safe system which prevents secondary disaster (enclosed area, etc.)</li> <li>- Setting the seismic grade as S for ensuring electricity, air conditioning, and sanitary performances</li> <li>- Individual air conditioning system for key rooms</li> <li>- Stopping of elevator cages on the nearest floor and setting seismic sensors</li> <li>- Reliable power supply and electrical storage function provided by uninterruptible power-supply system (UPS)</li> </ul>
	Interruption of electricity infrastructure	<ul style="list-style-type: none"> <li>- Back-up by dual service wires against interruptions to infrastructure</li> <li>- 80% of electric load are provided by emergency power generators, security power generators, and cogeneration</li> <li>- Fuel stockpiling for 3 days</li> </ul>
Short-term responses From the occurrence of disaster to 3 days later	Ensuring water	<ul style="list-style-type: none"> <li>- Ensuring water for 3 days, and setting drainage tanks</li> <li>- Dual-line water supply (clean water and general service water)</li> <li>- Selecting warehouses for stockpiling</li> </ul>
	Ensuring air conditioning	<ul style="list-style-type: none"> <li>- Setting emergency heat source system and cogeneration</li> <li>- Fitting emergency air conditioners, fans, and pumps to emergency power sources</li> </ul>
	Acceptance of patients	<ul style="list-style-type: none"> <li>- Ensuring triage space</li> <li>- Medical gas supply from temporary cylinders at emergency inlets</li> <li>- Setting medical gas outlets and emergency electric outlets for common areas</li> </ul>
Medium- to long-term responses (extensive disaster) From 4 days after the occurrence of disaster	Ensuring electric power sources	<ul style="list-style-type: none"> <li>- Setting backup feeders for connecting to power source cars</li> <li>- Optimum position of the filler necks of oil tanks</li> <li>- Central monitoring power demand control as a power saving measure (equipment control according to 20% saving)</li> </ul>
	Ensuring water	<ul style="list-style-type: none"> <li>- Refilling of reservoirs via emergency water inlets</li> </ul>
	Serving hot meals to evacuees	<ul style="list-style-type: none"> <li>- Selection of the best mix of kitchen instruments for both gas and electricity</li> <li>- Ensuring spaces for stockpiling food and water</li> </ul>

Figure 1. BCP flow of a facility at the time of disaster (in the case of a hospital)

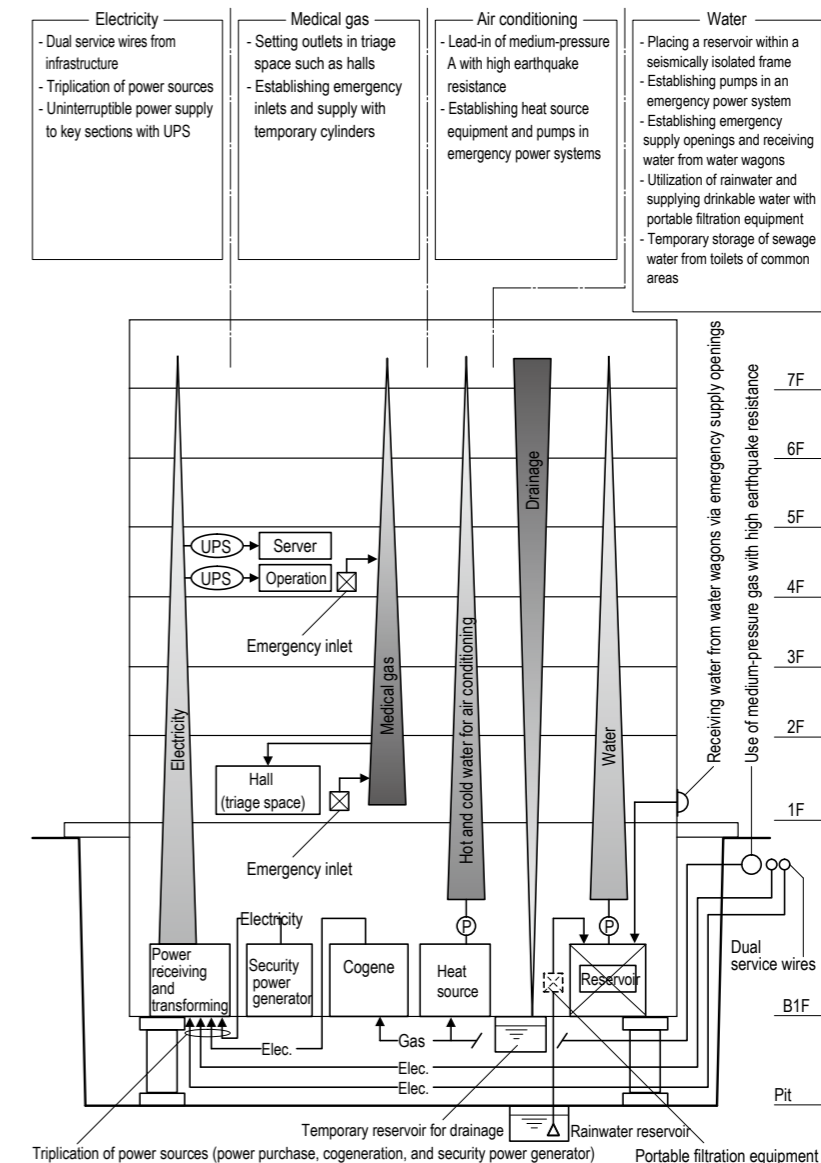

Figure 2. Example of emergency responses (in the case of a hospital)

## 13-4 Limitations and utilization of information infrastructures

There is no such thing as a separate information infrastructure; it is utilities that support business activities and people's lives. Electricity, water supplies and sewage, gas, transportation, road, locations and the earthquake resistance of buildings, food and water, and above all, human lives should all be protected and ensured. In this sense, the responsibility of architects is great.

### Information infrastructure and utilities

The information infrastructure in reality consists of the utilities themselves. Information is ensured when people and facilities/equipment are integrated. By looking back at the Great Hanshin-Awaji Earthquake and the Great East Japan Earthquake, and forward to a predicted earthquake in the northern part of Tokyo Bay, the issues concerning utilities are outlined below.

### The Great Hanshin-Awaji Earthquake

The final report of the Great Hanshin-Awaji Earthquake (January 17, 1995) has already been made public.

Based on the Road Act (Article 46) and Road Traffic Act (Article 4 to Article 6) police traffic control measures closed vehicle access from the day of the earthquake; the next day, January 18, based on the Road Traffic Act, emergency routes for vehicles were confirmed, emergency transportation routes to Kobe City were designated and all vehicle traffic except emergency vehicles was prohibited. On January 19, emergency transportation routes based on the Basic Act on Disaster Control Measures (Article 76) were designated and were enforced until February 24.

On February 25, transportation routes of goods for reconstruction as well as transportation routes of goods related to lives and reconstruction were designated, and would remain in place for nearly a year until lifted on February 19, 1996; all traffic controls were completely lifted on August 10, 1996.

On January 24, 7 days after the earthquake, the total evacuees peaked at 236,899. The maximum number of disaster refugees was 599, and construction of temporary dwellings started. All disaster refugees designated by Disaster Relief Act were completely closed on August 20, 1995.

The restoration progress of roads and transportation networks was as follows. The collapse of the Kobe Route of the Hanshin Expressway and bridge fall of the Gulf Route of the same expressway were very striking. After the outbreak of the earthquake on January 17, 1995, it took from six to eighteen months for their restoration; actual restoration of all affected arterial roads took about 3 years.

The restoration progress of utilities was as follows. The complete restoration of all water supply systems took 10 weeks, with a massive 50% or more completed only 2 weeks after the earthquake. Emergency transmission of electric power was completed 6 days after the earthquake, and the blackout rate was down to less than 10% only 2 days after the earthquake. Telecommunication was completely restored in 2 weeks after the earthquake. Gas was completely restored on April 11, 3 months after the earthquake; it was February 21, more than one month after the earthquake, the restoration rate of gas exceeded 50%.

### The Great East Japan Earthquake

For reasons of space in this book, outlines are limited to restoration of electric power for rough reference. It should also be noted that at the time of writing this is not the final report.

Just under 5 million households in the Tohoku Electric Power area covering the Aomori, Iwate, Akita, Miyagi, Yamagata, and Fukushima prefectures were hit with blackouts on the day of the earthquake, March 11, 2011; 50% were restored by the night of March 12, 90% were restored by the night of March 16. It took 5 days for 90% of the blackout dwellings to be restored.

Restoration was slowest in Miyagi prefecture where 50% were restored by the night of March 14, and 90% were restored by the night of March 20, nearly 10 days after the earthquake.

In the Tokyo Electric Power area covering Tokyo, Kanagawa, Tochigi, Chiba, Saitama, Gunma, Ibaraki, Yamanashi, and Shizuoka prefectures, nearly 100% were restored by the night of March, 12, one day after the earthquake.

### Predicted M7.3-scale earthquake in the northern part of Tokyo Bay

Table 1 shows estimations of damage and restorations of utilities for a predicted M7.3-scale earthquake in the northern part of Tokyo Bay.

### Business Continuity Plan by Ministry of Land, Infrastructure, Transport and Tourism

The estimation of damage to the information infrastructure, including that for safety confirmation, which is essential immediately after an earthquake, is outlined below based on the "Business Continuity Plan by the Ministry of Land, Infrastructure, Transport and Tourism" (June 2007, Ministry of Land, Infrastructure, Transport and Tourism). It is estimated that depending on the facility, the emergency restoration of electric power will take 1 to 6 days, although central administrative functions, hospitals, etc. will be preferentially restored.

It is assumed that in the case of an earthquake direct hit on the Tokyo area, telephone lines of telecommunications carriers such as NTT will have weak reception for 7 to 10 days, which is longer than the 6 days of the Great Hanshin-Awaji Earthquake. It is also assumed that due to congestion, cellular phones will have weak reception for a week or so. However, packet communication (reception and transmission of e-mails by cellular phones) is assumed to be available.

The internet is assumed to be unavailable for about 6 days after the earthquake because communication lines will be interrupted and will not be restored by the carriers.

### Telecommunication services and the Great East Japan Earthquake

In the aftermath of the Great East Japan Earthquake, for the two days March 12 and March 13, the number of NTT East interrupted communication service lines peaked at 1.4 million, and was not to stabilize until some 10 days after the earthquake, around March 22.

The total of all users of the Disaster Emergency Message Dial (171) was 3.2 million; operation stabilized around March 16, before dramatically dropping on and after March 20. The cumulative user figure for the Disaster Message Board (Web171) was about 250,000 less than 10% of the Disaster Emergency

Message Dial (171).

According to questionnaire research into the means of communication on the day of the earthquake (the University of Tokyo, NTT Laboratories, etc.), Disaster Emergency Message Dial users accounted for about 10%, the most popular means of information-telecommunication were cellular phone e-mail, followed by cellular phones. It would be interesting to know the percentage of cellphone users familiar with sending cellphone emails? PCs do not operate without an electricity supply, but land-lines work well at the time of a disaster.

### Free public telephone and public telephones

What is noteworthy is the free public telephone service. Installation of free public telephones started on the day after the earthquake, rapidly increased on and after March 15, and became stable at 2,300 phones on and after March 25.

Public telephones are classified into Type 1, which is provided at the time of a disaster, and Type 2 for the purpose of business. Although there were 800,000 public telephones across the country at the time of the Great Hanshin-Awaji Earthquake, removal of Type 2 public telephones had escalated because of their unprofitability; very few remain on the streets today.

As land-lines work well at the time of a disaster, architects should rethink the role of the humble low-tech land-line.

### The Miracle of Kamaishi and tsunami tendenko (everyone for themselves)

In Kamaishi, almost nearly all the 3,000 elementary and junior high school students miraculously survived the tsunami;

judging that the designated disaster refuges were dangerous, they ran to higher ground and survived. This heartening event came to be known as the "Miracle of Kamaishi."

Behind this miracle actually lay many years of dedicated disaster prevention education as taught by Toshitaka Katada of Gunma University. The apparently hard saying "tsunami tendenko (everyone for themselves)" actually means each individual is to trust that their family members will be running to the high ground too, so no time is wasted looking for others.

Architects should design by not only depending on tangible skills but also incorporating hidden intangible measures. As Rachel Carson wrote in her great book "Silent Spring," "Without the earth's soil, there could be no plants; and without plants, there could be no animals of any kind." (Yukio Osawa)

### References

- (1) Written and edited by Yukio Osawa, Jishin risuku taisaku tatemono no taishin kaishu jokyakuho (Countermeasures Against Earthquake Risks: Methods of Seismic Retrofit and Removal of Buildings), Chuokeizai-sha, 2009
- (2) Written and edited by Yukio Osawa, Kenchikushi kaikeishi zeirishi no saigai FAQ (Disaster FAQ for the Architect, Accountant and Tax Accountant), Chuokeizai-sha, 2011
- (3) Yoshiaki Kawata, Tsunami saigai: Gensai shakai o kizuku (Tsunami Disaster: Creating a Disaster Resilient Society), Iwanami-shinsho, 2010

### (1) Damage of utilities (%)

	(i) Electric power (blackout rate)	(ii) Telecommunication (interruption rate)	(iii) Gas (interruption rate)	(iv) Water supply (interruption rate)	(v) Sewage (damage rate of sewers)
Tokyo metropolitan area	16.9	10.1	17.9	34.8	22.3
Wards area	22.9	13.2	22.9	46.3	25.4
Tama area	2.4	1.9	0.0	10.9	17.7

Note: "Damage rate of sewers" refers to the ratio of the total length of damaged sewers with flow difficulties compared to the total length of sewers.

### (2) Estimation of restoration of utilities (%)

	The day of occurrence	After 1 day	After 4 days	After 1 week	After 1 month	Number of days required for restoration
(i) Electric power (blackout rate)	16.9	13.2	5.3	0.0	0.0	6 days
(ii) Telecommunication (interruption rate)	10.1	10.1	2.8	2.1	0.0	14 days
(iii) Gas (interruption rate)	17.9	15.9	14.8	13.7	8.0	53 days
(iv) Water supply (interruption rate)	34.8	34.8	7.0	5.7	0.0	30 days
(v) Sewage (rate of sewers with flow difficulties)	22.3	2.8	2.4	1.9	0.0	30 days

### Notes

1. Number of days required for restoration: The day of occurrence is excluded.
2. Value of electric power after a day: The buildings assessed by damage investigation as difficult to live in due to damage by fire or collapse were excluded.
3. Value of electric power after a week: Blackouts unable to be restored due to interruption of transportation were excluded.
4. Interruption rate of telecommunication: The buildings assessed by damage investigation as burnt down or totally collapsed were excluded for the values after 4 days or later.
5. Gas: Damage investigations were implemented on the first day after the occurrence and the areas to be restored were determined.
6. Water supply: Only water supplied by Tokyo Metropolitan Government is included.
7. Rate of sewers with flow difficulties: Ratio of the total length of damaged sewers with flow difficulties compared to the total length of sewers.

Table 1. Estimation of damage and restoration of utilities (in the case of a M7.3 earthquake in the Northern part of Tokyo Bay)

# 14 Community Development and Earthquake Disaster Countermeasures

## 14-1 Buildings and community as social wealth

A building maintains its value on a public stage called "community." A building that is integrated into a community provides a higher quality of life for citizens and contributes an invisible value known as social wealth. To build buildings and communities is the aim of "community development," and a good community not only enhances everyday life but also provides us with safety.

### Buildings locate in communities

Needless to say, buildings are the key factor in the makeup of cities, and depending upon their location and purpose, there is an almost infinite variety. In any major city, central area buildings will be different from those in suburban areas, and in provincial cities, buildings may respond to the environment and climate and reflect a variety of often unique and complex factors such as regional and historical characteristics. Moreover, farming, mountain, and fishing villages and even resorts all have their own style of buildings.

All these buildings exist by depending on transportation facilities including roads and railroads, and utilities such as water supply and sewage systems. They are also protected by civil engineering infrastructures, including facilities such as embankments and windbreak forests. Buildings are the social wealth that supports the social and economic activities of citizens across the county, and function best by being in harmony with their immediate and greater environment, including cities and nature (all these factors are collectively called "community" or "a community" hereafter).

Buildings which constitute community vary widely and include houses, public facilities such as government buildings, hospitals, and schools as well as production facilities. Although architects design such buildings on a daily basis, they are simultaneously required to recognize that they are designing a part of community, including the surrounding environment of the building, and that designing a building constitutes an act of "community development."

Looking at the damage caused by the Great Hanshin-Awaji Earthquake and the Great East Japan Earthquake, we can understand how greatly buildings depend on infrastructures. It has become clear that a single building cannot resist an earthquake, and the disaster prevention capacity of a community as a whole is called into question. Architects can only exist within community, and that is why architects should address community development.

### Understanding disaster risks

Among the basic performances of a building, indexes of safety are determined based on the system of the Building Standard Law of Japan. In addition, the natural environment including the surroundings, as well as social factors should also be considered. In other words, architects should design buildings based on an understanding of community, that is, they should address architectural design as a part of community development.

Since the Great Hanshin-Awaji Earthquake, many municipalities have focused on disaster prevention measures and policies, established dedicated departments and addressed disaster countermeasures including urban planning, social welfare, and education. But in the Great East Japan Earth-

quake, the massive power of the tsunami, in addition to the earthquake and ensuing fires, inflicted devastating damage on communities themselves as well as many lives.

It became clear that safety countermeasures for a single building are powerless to resist an earthquake; as designers it is necessary to be humble in the face of nature's awesome power. Geological investigations and ground surveys have long been essential in traditional earthquake-resistant design. However, in addition, the safety design of buildings in conjunction with comprehensive disaster countermeasures for many different types of natural disaster is required.

Around the time of the Great East Japan Earthquake, areas of Japan suffered landslide damage from strong typhoons and damage from tornadoes. Furthermore, recent local torrential downpours in urban areas caused great flood damage resulting in fatalities. These events have made it clear that communities cannot resist the fury of the elements. Many municipalities have released information on comprehensively assessed risks of "community" including not only earthquake risks but also disaster risks (Figures 1 and 2). It is essential for architects to correctly understand and incorporate such basic information into their practice.

### Developing favorable communities through architectural design

Traditional earthquake-resistant design focused purely on the structural design of a single building. Since the Great East Japan Earthquake, however, various issues concerning restoration have been highlighted, including weaknesses in terms of the locations of buildings and towns, evacuation guidance at the time of disasters, and temporary housing. This underlines the importance of architects approaching architectural design with sufficient understanding of environmental characteristics as a complex of nature and history, culture, and the economy of surrounding areas; it is evident that architectural design from the perspective of community development is required from architects.

To that end, study work beyond a "given site" becomes essential. By viewing at least several blocks surrounding the site, efforts should be made to develop a favorable community in conjunction with the building, including studying the relationships with neighbors and routes to schools and parks, and by being aware of harmony in town landscapes and so on (Figures 3 and 4). Such an attitude to design constitutes a style of "community development" that can only increase the social asset value of buildings and towns.

(Hiroo Nanjo)

□ Sources of figures

- 1) Based on the information provided by Shibuya Ward
- 2) Edition by the Special Committee on Urban Disaster, the Japan Institute of Architects, Kenchikuka no tame no taishin sekkei kyohon (Earthquake-resistant Building Design for Architects), Shokokusha, 1997



Figure 1. Earthquake Disaster Hazard Map (an excerpt from the information provided by Shibuya Ward, Tokyo): The map divided into a 50 m grid shows the building collapse risk classified into 7 categories. The building collapse risk is determined based on the following factors; the distribution of predicted seismic intensity shown in the earthquake susceptibility map, the structure of buildings (wooden or non-wooden) and the year of completion, the building shape observed in a visual inspection of a building exterior, and the time index1)

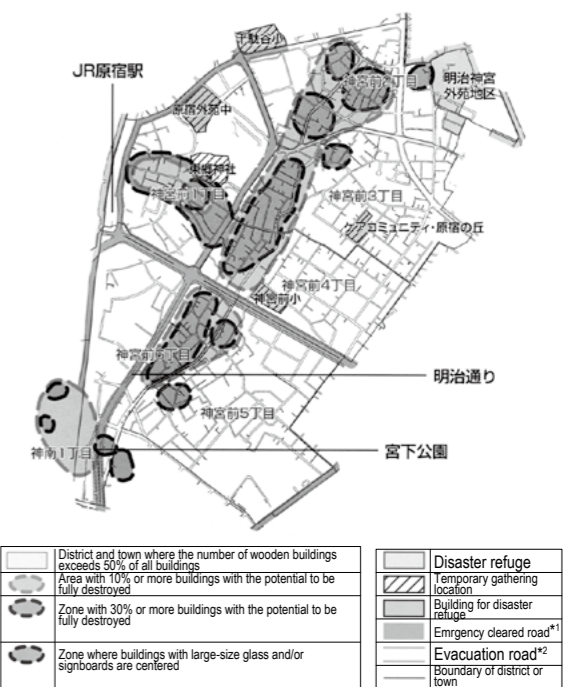

\*1 Road where traffic is ensured as a priority  
\*2 Road for safe evacuation to a disaster refuge designated by Tokyo Metropolitan Government

Figure 2. Area risk map (Shibuya Ward, Tokyo metropolitan area)1)

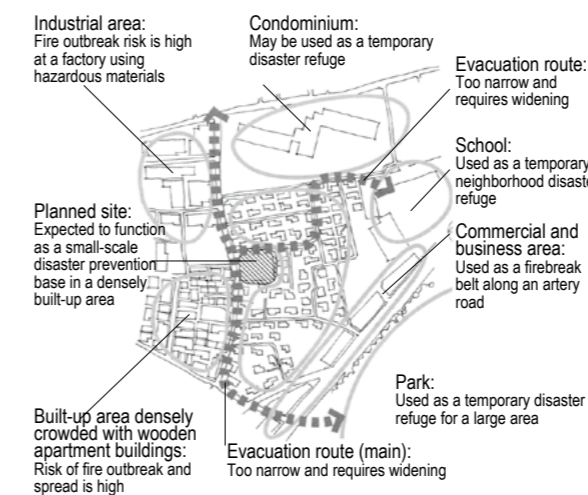

Figure 3. Diagram for understanding the present situation2)

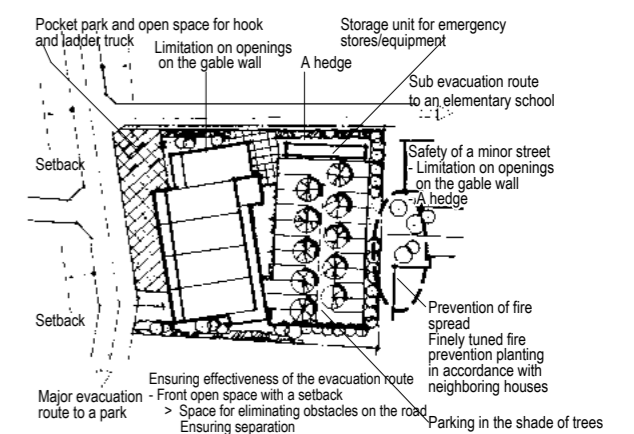

Figure 4. Diagram of design policies2)

## 14-2 Integrating disaster prevention functions into a community

A building is founded on a variety of existing environments (community). By means of not only ensuring the earthquake resistance of a single building, but also integrating disaster prevention functions into a community, the building becomes more robust along with the community, and collectively the whole protects the lives of the citizens at the time of a disaster.

### Utilizing the existing surrounding property

In Japan, ownership of land has been held in the highest regard, the right to use the land as private property completely at the landowner's disposal is given priority over all other factors, and awareness of the public nature of land as a part of a community has faded. It seems that architects, being employed by the landowner in many cases, have naturally on behalf of their client, exercised the owner's interests to the maximum extent under the law, and have forgotten the public nature of land. It also seems that on the pretext of effective utilization of land, new construction has been given the highest priority, and indigenous environmental factors have been neglected or destroyed.

In traditional residential areas, the old hedges and trees surrounding residences are rapidly disappearing due to the subdivision of land through inheritance or for making parking spaces. Many old wells and ponds are also eliminated at the time of rebuilding. Even though there are underlying causes in the tax system and urban policies, architects should practice community development in cooperation with the surrounding environment, and attempt to enhance the social value of buildings and the community as an asset, with consideration of such aspects as regional disaster prevention and town landscapes (Figures 1 and 2). Architects should in their ordinary activities start by assessing natural environmental resources and integrating them into their designs.

Conventional developments of apartment houses and detached houses as well as large-scale urban redevelopments have had a strong tendency toward prioritizing business feasibility, and as a result, natural environments have gradually been lost. However in recent years, with the growing awareness of sustainability, increasing numbers of development plans are being seen, which address conservation and regeneration of large-scale green space and include these factors as a disaster prevention base. It is also effective to not only ensure sufficient green and open spaces and open them up to the public, but also to take measures utilizing surrounding resources and useful ideas and proposals such as establishing stockpile warehouses, emergency toilets, and the invention of the dual-use cooking stove stool (Figures 3 to 7).

### Cooperation with public space

At the time of a disaster, the response of an individual building is limited, and the disaster resistance performance of the community as a whole is called into question. The community should be developed as a system prepared against disasters, by considering the multi-purpose use of any public spaces including roads, open spaces, parks, fields, mountains and forests, rivers, and ports. Unfortunately, architects seldom become involved in the development of these public spaces because they are usually developed as government-driven ur-

ban plans. It has become clear, after the Great Hanshin-Awaji Earthquake and the Great East Japan Earthquake, that urban plans based on vertically segmented administrative systems prevent comprehensive disaster prevention countermeasures. It is now evident that the need for the involvement of various architects in the decision system of community development and urban planning has been reaffirmed.

On the other hand, architects often play a leading role in the design of public facilities such as government buildings, schools, and hospitals. They should design these facilities considering not only their original routine functions, but also the functions as a disaster prevention base at the time of a disaster and a reconstruction base after the disaster. In such cases, it is effective for architects to cooperate with not only design-related professionals such as civil engineers and landscape engineers, but also experts in different fields such as medical care and social psychology. Architects should exchange information and cooperate with a wide range of people concerned, and on a regular basis foster better understanding of disaster prevention architecture.

### Activities of disaster-proof community development

As clearly shown with the two great earthquakes, it is not the initiative of a governmental entity, but more the grassroots endeavors of the residents towards community activities that plays a greater role. In Japan, in response to the past experience of a number of great disasters, such activities undertaken by resident associations and fire companies, as well as those disaster prevention activities within companies and organizations are functioning quite well. However, these activities are focused on minimizing damage, and stop short of the stage of disaster-proof community development.

To promote disaster-proof community development, not only ordinary citizens as a leading player, but also public administration that supports the citizens from a public standpoint, as well as experts who support and guide the citizens with expertise and experience are required. Though participation of experts in various fields including urban planning and civil engineering is expected, architects actually should be the expected standard bearers of disaster-proof community development. Architects should not only design buildings as professionals, but also devote themselves to addressing the issues for the community, in cooperation with the community residents on a regular basis, and to obtaining the extensive knowledge required about the community and skills, which will allow them to fulfill the role of standard bearer (Figure 8).

In recent years, the concept of "community architect" has been increasingly discussed. This term means the role of an architect as a sort of town doctor, who not only designs buildings but also engages in their practice from the perspective of an expert of community development. Indeed, the architect is one candidate for playing a leading role in disaster-proof community developments.

(Hiroo Nanjo)



Figure 1. An old well. During construction of a condominium in Minato Ward, this old well played an active part in the Great Kanto Earthquake; it was decided to preserve it for future emergencies.



Figure 2. Tsukui Kushikawa Community Center (Kanagawa prefecture). A plaza integrated with the neighboring shrine ground provides a place to relax in everyday life, as well as functioning as a base for a community fire brigade, and is equipped with a wireless station for disaster prevention (photo: Akira Shimizu).



Figure 3. Emergency goods and equipment in a condominium warehouse

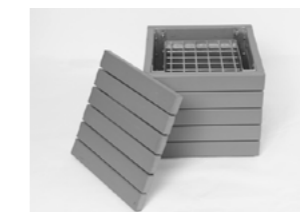

Figure 4. A dual-use cooking stove stool, which is set in a park, etc. (photo: Haseko Corporation, the same for Figures 5 and 7)



Figure 5. "Well Up," an emergency water generation system. It is ordinarily stored in the emergency stockpile warehouses of a condominium



Figure 6. An emergency bag



Figure 7. An emergency man-hole toilet



Figure 8. An investigation promoting the renovation for earthquake-resistant houses in Shibuya Ward; the ward commissioned the Japan Institute of Architects to make a visual investigation of about 10,000 wooden houses built based on the old standards (photo: JIA Shibuya).

### 14-3 Regional planning prepared against fire

Fires associated with a great earthquake are likely to rage out of control into large-scale urban fires. It is common knowledge that in past earthquakes including the Great Kanto Earthquake, Great Hanshin-Awaji Earthquake, and Great East Japan Earthquake, urban areas suffered great damage from fires. The planning of disaster-proof communities, or fire-resistant and collapse-resistant communities, prepared for those earthquakes assumed in the future, has become very important.

#### Earthquake fire

In the Great Hanshin-Awaji Earthquake, 293 fires destroyed more than 7,000 buildings (confirmed by the Fire and Disaster Management Agency on May 19, 2006).

The Great East Japan Earthquake caused 284 fires (Report on damage caused by 2011 Tohoku Earthquake by the Fire and Disaster Management Agency (Report No.145), March 13, 2012). Seven of them were in Yamada-machi, Iwate prefecture, of which two extensive urban fires burned over an area of about 16 ha. In addition, large-scale urban fires raged in Ishinomaki City and Kesenuma City of Miyagi prefecture (reported by National Research Institute of Fire and Disaster on April 26, 2011). It is a characteristic of earthquake fires to spread over large areas relative to the number of fires (Figure 1).

It is said that there is a correlation between maximum seismic intensity and the number of fires, and areas subject to great quakes have a tendency to suffer many fires. At the time of the Great East Japan Earthquake, in addition to earthquake fires, so called tsunami fires broke out sporadically; this type of fire is spread by the tsunami carrying burning buildings, cars or rubble (Figures 2 and 3). Even fire engines were sunk by the tsunami and rendered useless. It is evident that tsunami fires are far more volatile than the more usual earthquake fires caused by collapse of buildings, etc.

It is important to draw upon past experience and also anticipate the causes of fires and verify spread patterns for both earthquake fires and tsunami fires; measures to prevent large-scale fires and to reduce damage due to fires spreading should be taken.

#### Degree of district danger

The degree of damage from an earthquake varies by district. By understanding the vulnerability of a district to earthquake, measures should be taken and updated on a regular basis. The Tokyo Metropolitan Government has published tables showing the degree of district danger about once every 5 years since 1975. They include the following 3 indexes.

1. Degree of danger of building collapse (risk of building collapse)
2. Degree of danger of fire (risk of spread due to fire)
3. Degree of comprehensive danger (risk of building collapse and spread due to fire)

These degrees of danger have been given according to a five grade evaluation system to each of the 5,099 districts and towns within the urbanization promotion area of the Tokyo metropolitan area. These results have been utilized not only for disaster-proof urban development including the provision of firebreak belts with roads, etc. and fireproofing of buildings, but also for promoting preparation against disaster by pro-

viding citizens with a correct understanding of the risks of the districts where they live.

#### Damage supposition

Damage supposition aims at providing basic information for disaster prevention measures by estimating damage situations at the occurrence of an assumed earthquake and in accordance to the actual conditions of each area. However, for the Great East Japan Earthquake, actual damage far surpassed projected damage in each of the stricken areas. Although it is very important to improve the accuracy of damage supposition by accumulating scientific findings in order to reduce damage in critical situations, it should be noted that damage supposition is undertaken to simply assume that "when an earthquake of a certain intensity occurs, the area may suffer damage of this amount," and it does not guarantee the scale of earthquake and the maximum extent of damage.

It is necessary to prepare measures not only based on damage supposition, but also against situations likely to arise when the scale of the earthquake surpasses the assumption.

#### Fire resistance of buildings

As fire resistant buildings increase, the ratio of noncombustible area(1) also increases, and a city becomes correspondingly more fire resistant. However, in the foreseeable future wooden buildings including wooden houses will never disappear. Though fire resistant wooden buildings exist, many of them are built with quasi-fire-resistant construction or fire-retardant wooden construction.

Buildings with fire-retardant wooden construction, which have exterior walls finished with mortar, rapidly became popular after World War II and many of them still exist centered on built-up areas densely crowded with wooden buildings. Although a certain level of fireproof performance is recognized from a mortar finish on metal lathing, even if the building did not collapse, the fireproof performance would be lost at the time of an earthquake due to the mortar falling. Regarding earthquake fires, practically, fire-retardant wooden construction should be regarded as similar to an exposed wooden building.

#### Fire spread prevention in urban areas

As multiple fires associated with an earthquake will occur simultaneously, the number or area of fires soon overwhelms the fire-fighting capacity. It has been found that not only fire-fighting techniques, but also urban structures, including the structure and the density of buildings, as well as the availability of open spaces greatly contribute to controlling the burning of large-scale fires. The following are two major contributory factors.

1. Open spaces such as roads, railroads, and parks
2. Buildings with fire resistance

According to the research on fire control measures at the time of the Great Hanshin-Awaji Earthquake conducted by the Fire Research Institute (present National Research Institute of Fire and Disaster), fire control caused by roads, railroads, etc. accounted for about 40%, and that caused by fire resistant buildings and open spaces accounted for about 23%.

To prevent great urban fires, increases in the ratio of noncombustible area, developments of firebreak belts(2), removal of minor streets that prevent fire-fighting activities, etc. is

required (Figures 4 and 5).

To ensure the performance of firebreak belts such as roads, in addition to the widening of roads, it is required to make the buildings along the roads fire-resistant and high-rise, as well as to fireproof the buildings situated to the back.

At the time of a disaster, safe evacuation should be ensured from a community road within a certain area surrounded by firebreak belts to the location of a disaster refuge.

(Shoeki Kurakawa)

□Notes:

(1)Ratio of noncombustible area: an index which indicates non-combustibility of an urban area. At 70%, the ratio of fire destruction becomes nearly zero. It is defined by the following formula.  
Ratio of noncombustible area (%) = Ratio of open space\*1 + (1-Ratio of open space/100) x Noncombustible rate\*2

\*1 Ratio of open space (%): Ratio of the total area of parks, roads, etc. which meet a certain level of requirements

\*2 Noncombustible rate (%): Ratio of the total building area of fire resistant buildings, etc. to the total building area of all buildings in the area

(2)Firebreak belt: it consists of urban facilities such as roads, parks and rivers as well as noncombustible buildings alongside the roads, and prevents the spread of fire. It aims at preventing great urban conflagrations and ensuring evacuation routes and spaces for rescue activities.



Figure 1. A school burnt by spreading fire (Ishinomaki City, Miyagi prefecture)



Figure 2. Burnt cylinders (Ishinomaki City, Miyagi prefecture)



Figure 3. A fire engine swept away by the tsunami (Natori City, Miyagi prefecture)

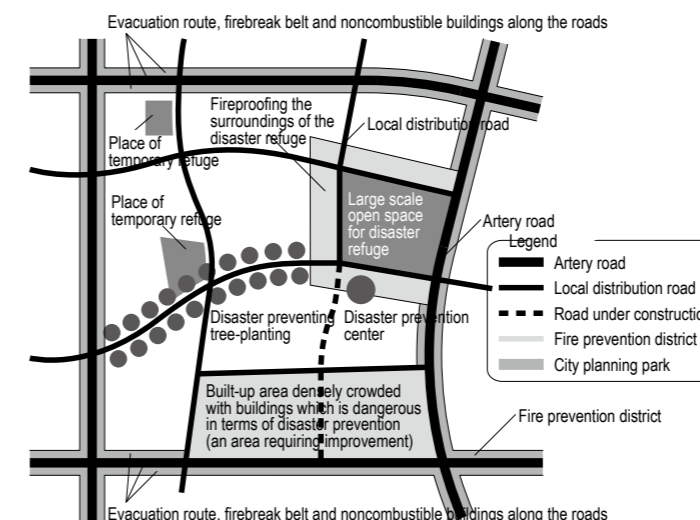

Figure 4. Image of disaster prevention urban structure(1)

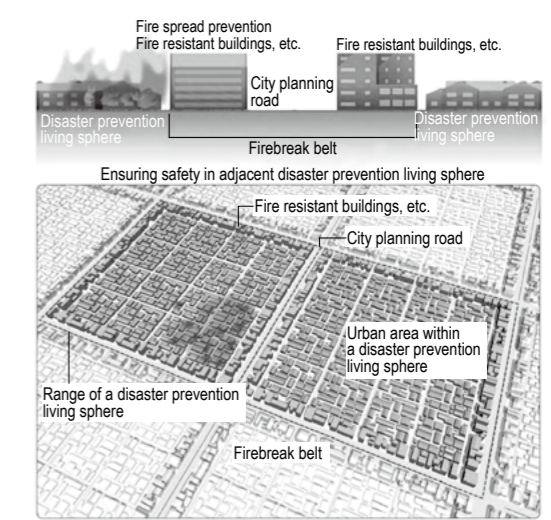

Figure 5. Image of disaster-proof urban development and firebreak belts(2)

□Sources of figures

- 1) Based on information of the City and Regional Development Bureau, Ministry of Land, Infrastructure, Transport and Tourism
- 2) Based on the 2010 Promotion Plan for Disaster-proof Urban Development



## 14-4 Disaster prevention function of exterior space

Exterior spaces require safety measures to protect against the collapse of buildings and falling objects at the time of an earthquake. In addition, measures should be prepared for the exterior space to be effectively utilized as evacuation routes and for locating disaster refuges after the earthquake.

### Density and road/open space

Today, for most areas of our cities building coverage ratios and floor area ratios are stipulated by city planning according to the use zone. A maximum allowable ratio of total floor area of a building to the site area is stipulated for all districts ranging from residential districts with relatively low densities, to commercial or business districts with high densities, and therefore approximate population densities, employed population densities, etc. can be estimated. At the time of the Great Hanshin-Awaji Earthquake, dense housing areas showed a concentration of human casualties because the earthquake occurred in the early morning; each time of day will show a different pattern and scale of casualties. Death by crushing due to the collapse of wooden houses while sleeping accounted for the majority of casualties in this earthquake, and fortunately, damage was much less in the areas surrounding the houses, such as gardens, roads, and open spaces.

When considering earthquake disaster countermeasures for the exterior spaces of buildings, consideration should be taken for both the safety measures to be taken at the occurrence of an earthquake, and the requirements to be met for exterior space acting as evacuation routes and places for disaster refuge immediately after the earthquake. To improve the safety of urban areas at the time of an earthquake, the density of population and buildings should be controlled at appropriate levels and excessive concentrations avoided. In the case of commercial or business districts, where a certain level of concentration is inevitable due to the nature of activities, adequate open spaces should be ensured around buildings, and green spaces with trees, etc. and water surfaces should be planned (Figure 1). It is known that if glass or curtain walls of a high-rise building fall off during the earthquake, they would scatter to a distance of about the height of the building. In addition to the danger of direct hits by falling objects, any materials scattered on roads and open spaces may block the passage of emergency vehicles and evacuees, as well as hinder the functions of open spaces acting as disaster refuges. Today, open spaces in the form of walkways and plazas as public open spaces made by taking advantage of planned development design systems are often provided as precious open spaces in urban areas (Figure 2). However, these open spaces can rapidly become dangerous or useless space if safety measures and preparation for effective utilization after an earthquake disaster are inadequate. Last year, in preparation for great earthquakes which are predicted to occur in the near future, Tokyo Metropolitan Government designated certain Tokyo roads (total length: 2,000 km) as emergency routes for rescue, fire-fighting, goods transportation, etc. and started a project to promote the earthquake-proof conversion of buildings alongside the roads. The initiative obliges any building which could block road traffic to undergo a seismic diagnosis, and subsidizes the diagnosis and the improvement of the building.

### Ordinary function and extraordinary function

Open spaces in urban areas that are beautifully landscaped with much greenery and many water surfaces, such as ponds and streams, ordinarily are precious reminders of nature in our cities, give much pleasure to the eye with the changing of the four seasons, and also provide sanctuary for birds and insects. Such an apparently cosmetic and pretty scene, soon comes into its own in the event of an earthquake; greenery surrounding buildings acts as a living buffer against falling objects and functions as effective firebreak belts. The water in ponds and streams will be used for fire-fighting and washing. Any large open spaces will become essential spaces for disaster refuges, liaison offices, and spaces for stockpiling and supplying relief supplies. After the Great Hanshin-Awaji Earthquake, central facilities of communities commonly used by the residents such as elementary and junior high school playgrounds and neighborhood parks soon became disaster refuges, locations for emergency temporary housing and so on. Open spaces of varied size and shape should be ensured in urban areas, not only to improve the safety of urban areas, but also to facilitate rescue activities after an earthquake, and their key roles and networks at the time of a disaster should be further acknowledged and built up.

### Structures and finishes

Firstly, as measures for the safety of the exterior space surrounding a building, it should be ensured that fences and street walls, retaining walls, ponds, trees, and other structures, to say nothing of buildings which line the exterior space, have a robust structure that will not collapse or fall in at the time of an earthquake. Many collapses of concrete block walls as well as disruption of retaining walls with stones or concrete on sloping lands were observed in past earthquakes. Measures to prevent this damage such as replacing any concrete block wall with a hedge, dividing a high retaining wall into two or three steps and strengthen the foundation, etc. should be considered. Also after the Great East Japan Earthquake, much damage was seen in coastal reclaimed lands; buildings leant over due to liquefaction of the ground, surrounding pavements and parking lots suffered cracks and bumps and became unusable, and utilities including water supply and drainage systems were severely damaged. For those areas where liquefaction may occur in the future, countermeasures such as soil improvement should be taken. The adoption of materials and/or building construction should also be considered that enable easy restoration, if damage should occur. Secondly, protection measures should be taken against glass and walls, as well as other objects, such as air conditioner outdoor units falling or collapsing into the exterior spaces. Although it is effective to place buffer zones with trees and/or ponds around buildings, there is no doubt that the appropriate design of buildings themselves, such as incorporating details which prevent the breaking or falling of glass, adopting finishing materials which do not come off, or planning eaves or lean-to roofs which catch falling objects, is a top priority.

### Building equipment

The exterior spaces of buildings, especially open spaces in urban areas are expected to play a variety of key roles at the time of a disaster (Figure 3). When they are utilized as places

for disaster refuge, they should not only be made safe against secondary disasters such as fires, but also should become bases for ensuring food and water, disposal of excreta, collecting correct information and so on until utilities are restored. Open spaces of a certain size should be utilized as places for storing foods, blankets, tents, temporary toilets, etc. and establishing stockpile warehouses, and should be planned as places to provide drinkable water with wells and reservoirs, etc. Whether living as a refugee is comfortable or not is greatly dependent

on the disposal of excreta; establishing and maintaining many temporary toilets or developing local treatment systems is essential. Disaster victims and persons involved want to obtain information about the disaster and on safety, as well as find a point of contact for close relatives, friends and acquaintances. Places for disaster refuge should ensure telecommunication measures based on wireless networks to provide such information in quick and accurate ways. (Susumu Kono)



Figure 1. 555 SQUARE of Shinjuku Mitsui Building



Figure 2. Public space at New Pier Takeshiba (Minato Ward, Tokyo)



Figure 3. The Tokyo Rinkai Disaster Prevention Park. While ordinarily functioning as a park, in the event of a disaster, it acts as a central base of operations for disaster control.

## 14-5 Earthquake resistance of civil engineering structures and other structures

Transportation facilities such as ports and airports, and roads and railroads should be able to support rescue activities and the transportation of relief goods in the aftermath of great earthquakes. Serial seismic strengthening of these facilities is being undertaken with the aim of limiting any earthquake damage to a certain level and so that the facilities can be quickly restored. Countermeasures against the settlement of river banks are being taken to prevent the inflow of river water into urban areas at the time of an earthquake.

### Civil engineering structures as utilities

Transportation, information and living-related facilities including ports and airports, roads and railroads, river banks, gas, electricity and water supplies and drainage, and telecommunications have repeatedly suffered damage in earthquakes.

Since the 1978 Miyagi Earthquake, the loss of facility functions due to earthquake damage and the delay in their recovery greatly affected the lifesaving and treatment of victims, economic activity, and civic life. To reduce the risks, serial seismic strengthening of these facilities is being implemented by authorities including the national government which is responsible for overseeing and monitoring such projects.

An issue commonly found when undertaking the seismic strengthening of such facilities is the difficulty in carrying out the work while still using the facilities. In this section, the present situation of earthquake resistance and methods of seismic strengthening are discussed with a special focus on transportation facilities.

### Ports and airports

Port and airport facilities should be capable of serving as bases for rescue activities and transportation of relief goods at the time of an earthquake.

One of the most important structures in a port facility are the quays and gantry cranes, and therefore seismic strengthening is being implemented to simultaneously ensure the earthquake resistance of both structures.

Quays include the gravity type, sheet pile, and pile-supported quay, any of which is prone to great damage from liquefaction of the foundation ground or background. The main countermeasures against liquefaction are generally compaction of sandy ground or strengthening liquefaction resistance with chemical grouting. However, it is extremely difficult to do this work while the facilities are being used. In the case of sheet pile quays, with the increase of control accuracy in the small diameter pipe jacking method, the quay is sometimes strengthened by placing tie rods as well as raking piles at places distant from the quay (Figure 1).

Especially in the case of pile-supported quays, quakes are amplified at the time of an earthquake, because the natural period of gantry cranes often matches that of the quay, resulting in further damage. Therefore, installations of seismically isolated gantry cranes have increased in recent years.

Airport runways must be flat, and cannot be used if they are uneven from liquefaction caused by an earthquake. To implement liquefaction countermeasures during the few hours when an airport is not used, construction methods enabling the set up and removal of construction equipment in this time

frame are required. The chemical grouting method or compaction grouting method, in which the ground is compacted by making bulbous solid bodies by injecting low fluidity mortar are often used.

### Roads and railroads

At the time of an earthquake, roads and railroads must be able to serve as the primary means of evacuation of residents out of the affected areas, as well as the primary means of transporting emergency personnel and materials for restoration and everyday goods into the area.

An obvious feature of roads and railroads is that they are linear structures including earthwork sections (fills, cuts, and embankment slopes), bridges, and tunnels. A break in just one section of a road or track due to an earthquake prevents it functioning as an emergency transportation route. Seismic strengthening of roads and railroads is being implemented, by determining their priority according to their importance, and by setting performance goals aiming that at a seismic motion of level 2, damage is limited to a certain extent, and any functions can be quickly restored, and that damage does not result in any fatalities and so on.

Among earthwork sections, fills with a height of 30 m, cut-and-fills in mountainous areas and fillings of valleys suffer more damage than other sections. As countermeasures, strengthening toes of slopes with gabion, drainage of groundwater within fillings with drainage boring, and strengthening with earth retaining and anchors are implemented. In Tokaido Shinkansen, after the 1978 Miyagi Earthquake, seismic strengthening works in which steel sheet piles are placed at slope toes of fills on both sides, and the tops of the sheet piles are connected with tie rods were implemented. Moreover, in order to prevent derailment accidents at the time of an earthquake, countermeasures including works for preventing ballast outflows, works for the reduction of differential settlement with ground reinforcing earthwork construction methods, works for preventing a difference of level caused by settlement of back filling under a bridge and so on have been taken.

On roads and sidewalks in urban areas, the settlement of back filling in sewage installation works, lifting of manholes, and difference of levels caused by settlement of back filling under bridges can all become traffic obstacles (Figure 2).

Regarding bridges, many damaged piers (Figure 3) and fallen bridges due to great displacement were observed in past earthquakes. Therefore, the strengthening of piers with linings of steel plate or carbon fiber sheet have been implemented. As a result, catastrophic events such as fallen bridges were prevented and the functions of bridges were quickly recovered after the Tohoku Earthquake. In recent years, aiming at the quick recovery of the functions of bridges after an earthquake, installations of sensors to identify damaged parts and automatic transmission systems have also been implemented.

Regarding tunnels, much damage including slope failures was observed near the entrances of tunnels, and work for strengthening slopes with anchors, etc. have been implemented.

### River banks

After the 1995 Hyogoken-Nanbu Earthquake, with the occurrence of river bank settlement with a maximum height of about 3 m and total length of 2 km near the estuaries of the

Yodo River, measures for preventing the inflow of river water into urban areas have been taken.

River bank settlement is caused by circular slip failures of the banks due to soft foundation ground or settlement of the whole bank due to liquefaction of the foundation ground. To prevent such damage, countermeasures including solidification of ground, with solidification materials such as cement, at the outside of the slope toes of fills (Figure 4), installation of steel sheet piles, and the liquefaction countermeasures described in Section 2-4 should be implemented. (Tetsuo Tabei)

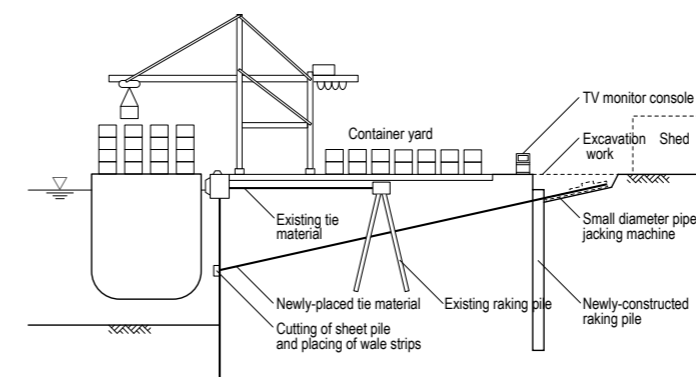

Figure 1. Seismic strengthening of a sheet pile quay<sup>1)</sup>

□Sources of figures

- 1) Takahiro Sugano, Efforts of seismic diagnosis and strengthening at ports and airports (Japanese), The Foundation Engineering & Equipment, April 2011, Sougou Doboku Kenkyusho
- 2) Earthquake Engineering Committee, Japan Society of Civil Engineering, Immediate Report on Site Investigation and Engineering Evaluation of the Great East Japan Earthquake by the Investigation Team of JSCE (Japanese), May 2011
- 3) Tetsuya Sasaki and Shunsuke Tanimoto, Efforts of seismic inspection and countermeasure at river banks (Japanese), The Foundation Engineering & Equipment, April 2011, Sougou Doboku Kenkyusho



Figure 2. Difference of level caused by settlement of back filling under a bridge



Figure 3. Damaged pier (left)<sup>2)</sup> and restored pier (right) (photo: both by Yoshikazu Takahashi, Disaster Prevention Research Institute, Kyoto University)

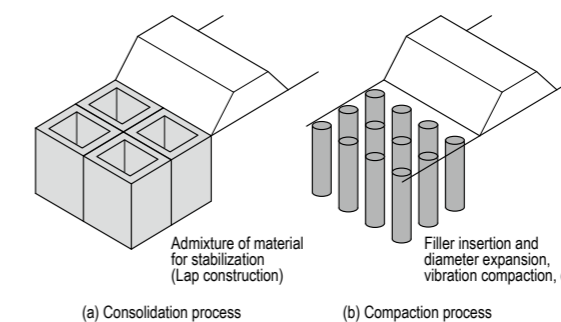

Figure 4. Liquefaction countermeasures for river banks<sup>3)</sup>

## 14-6 Philosophy of reconstruction plans

Experiences from past major disasters support our present life, as the results of the reconstruction efforts of our forefathers. Natural disasters are unavoidable, but from disasters we should learn and harmonize with natural laws, and apply them with humility in our reconstruction plans.

### Significance of reconstruction plans

In the field of urban planning, two plans are commonly known; Shinpei Goto's Imperial Capital Reconstruction Plan after the 1923 Great Kanto Earthquake and the war damage reconstruction plan after World War II. In recent years, the reconstruction plan of the Great Hanshin-Awaji Earthquake is still fresh in our minds. Regarding the Great East Japan Earthquake, the disaster headquarters were established based on the Basic Act on Reconstruction, and considerations on basic policies for reconstruction, etc. are being addressed.

Reconstruction plans have a special significance in not only transcending project frames based on traditional urban planning, but also having great time urgency. They inevitably comprise a "fundamental reform," and especially the issues of land ownership as well as arguments on interpretation of equality is often involved. For this reason, throughout the history of Japan many reconstruction plans ended with few noteworthy achievements.

After the Great Hanshin-Awaji Earthquake, a lot of reconstruction projects were implemented based on land readjustment and urban redevelopment projects. However, various issues were soon pointed out, including a lack of proper and rapid psychological treatment for victims, inadequacy of information disclosure, dissolution of communities, and unattended deaths. After the Great East Japan Earthquake, urban infrastructure such as roads suffered catastrophic damage from the tsunami. Therefore, serious challenges such as the relocation planning of towns and villages to higher ground, which cannot be handled by conventional urban planning, have been advocated. Moreover, with the additional complication of the Fukushima Daiichi Nuclear Power Station accident, the implications of reconstruction plans have varied a good deal depending on the region (Figure 1 and Table 1).

### Architect and reconstruction plan

Although reconstruction plans are a matter of national concern, how an architect should address this issue is unclear. Volunteer activity as a citizen is a valuable contribution, but how an architect should be involved in reconstruction as a professional is another story.

Looking at post-earthquake community reconstruction policies after the Great East Japan Earthquake, a typical architect's involvement as an expert of architecture includes participation in preparing reconstruction promotion plans, reconstruction development plans, etc. and in various development promotion projects prescribed as equivalent to the above plans, as well as directly providing physical support for various reconstruction-related activities.

To participate in these public projects, expertise in urban planning and civil engineering consultation is required. Therefore, some major architectural design offices and leading consulting firms account for a large portion of participation, and practically the participation of individual architects is unlikely.

Are architects not needed at the scene of reconstruction?

Quite the contrary, architects are actually expected to participate in various issues, especially those related to the quality of living space and the forming of communities as well as environmental symbiosis and sustainability; architects have been active in the reconstruction process of the Great East Japan Earthquake disaster. To address these issues, participation from not only architecture but also civil engineering, law, welfare, medical care, psychology, etc., as well as assessments based on legal and/or social systems are required. Therefore, architects should make their individual contribution to the team, while cooperating with other members and playing their role as an architect. To that end, architects should be prepared on a routine basis for such complexity and totality, which should be enabled through participation in "community development."

### JIA Charter of Community Development

The "JIA Charter of Community Development" was adopted at the 1999 JIA Congress in Kamakura. The charter's fundamental principles described the mission of an architect as to contribute to "community development," and declared that architects were to cooperate with citizens, public administrations, and experts, address the practice of community development, self-development, and design in the broadest sense of the term, and finally, participate in "community development" as both a professional and a citizen (Figure 2).

After the Great East Japan Earthquake, this charter is still effective, and may very well be called a charter for architects. From now on, every architect should behave in accordance with the spirit of this charter, not only when designing safe buildings, but also when participating in reconstruction plans as an architect.

(Hiroo Nanjo)

□ Source of figure

1) Shoji Sasaki, Framework and points of post-earthquake community reconstruction policies of the Great East Japan Earthquake (Japanese), City Planning Review, No.294

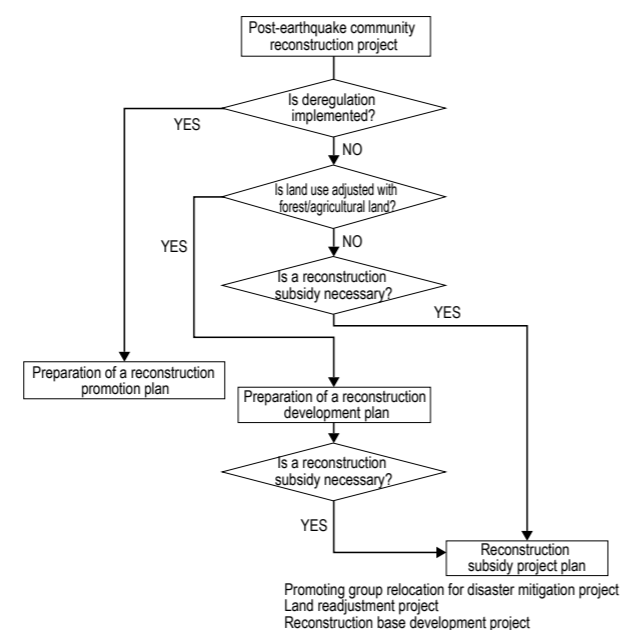

Figure 1. A workflow based on the Act on the Great East Japan Earthquake Special Reconstruction Areas<sup>1)</sup>

**JIA Charter of Community Development**

The living environment of Japan made rapid progress during the second half of the 20th century, and although the quality of individual buildings has improved, various issues are found in the present communities and cities as aggregates of buildings. From now on the improvement of the quality of communities and urban spaces, as well as the building up of a more productive environment, are the most important issues that we architects should address.

Taking this opportunity, responding to the demands of the present age, the Japan Institute of Architects establishes the "JIA Charter of Community Development" in order to clarify for society the basic position and role of architects in "community development."

[Fundamental principles]  
Architects contribute to "community development" through the design of buildings and environments by applying foresight and fostering a deep understanding of each area's community and civic life.

[Cooperation with citizens, public administrations and experts]  
Architects contribute to "community development" through their professional practices, in cooperation with citizens, public administrations and experts, by establishing credibility and employing their expertise.

[Practice and self-development]  
Based on extensive knowledge, architects hone their skills and continually make efforts for self-development, as a practitioner of the plans for "community development."

[Community development and design]  
Architects address design for excellent "community development" by considering nature, history, culture, community, safety, etc.

[Participation in community development]  
Architects proactively participate in rural development, town development and urban development in their professional capacity as well as being members of society.

Adopted at the JIA National Convention 1999 Kamakura on November 12, 1999

Figure 2. JIA Charter of Community Development

Preliminary study of method	Main projects for reconstruction subsidy (Urban disaster prevention comprehensive promotion project (subsidy for preparation of Post-earthquake community reconstruction plan, and for dispatching experts))			
Project method	Promoting group relocation for disaster mitigation project	Tsunami reconstruction base development project	Urban regeneration land readjustment project	
	Original location	New location		
Subsidy at planning stage	Subsidy for preparation of the plan		Subsidy for preparation of the plan	Subsidy for preparation of the plan
Subject of subsidy	Land acquisition cost of building site and agricultural land, and compensation cost for buildings	Land cost and development cost of public facility, land cost of public utilities, site preparation cost, and deficit in the resale area	Development cost of public facility, development cost of tsunami disaster prevention base such as tsunami refuge building, land cost of the whole area (excluding resale portion), and cost for raising the height of the whole area	Equivalent amount of land cost of public facility, development cost of public facility, and cost for raising the height (design population: 40 persons/ha or more)
Subject area	Regardless of inside or outside of city planning area	Inside of city planning area, in principle (also possible if city planning decision is made for the area outside), 2 areas for a municipality or 20 ha per area, in principle	Only inside of city planning area (enforcement by municipality is allowed, as well as urbanization control area and non-use zones are allowed)	
Scale requirement	None	5 dwellings or more	None	None
Area definition	A large enough scale to be designated as a disaster zone district is required	A grouped scale of 5 dwellings or more	Range of land acquisition is defined. It may be allowed to define the area for public utilities first and extend it later step by step.	A grouped scale enough to integrally develop access roads. An implementation area may be divided into two.
Implementing body	Prefecture or municipality			
Required legal procedure	Preparation of promoting group relocation for disaster mitigation plan and consent of the Minister of Land, Infrastructure, Transport and Tourism	City planning decision of urban facilities, and project approval by prefecture (or the state)	City planning decision of the area, approval of design outline, and approval of land readjustment council, provisional replotting designation, and replotting plan, and liquidation	
Procedure for reconstruction subsidy	Budgeting to reconstruction subsidy project plan, and application to reconstruction headquarters			
Subsidy rate	National Treasury virtually covers all the costs(subsidy plus special delivery tax)			
Changes in project plan after application for a reconstruction subsidy	Changes in project plan after application for reconstruction subsidy are easy for all the three projects because they are all subject to a reconstruction subsidy			
Tax measures	Special deduction of 20 million yen if original land was sold	None	If any land within the area is sold to the entity and any land is bought within the area, the transaction is exempt from capital gains tax for land transaction and real estate acquisition tax	Even if any land within the area is relocated through replotting in a land readjustment project, the transaction is exempt from income tax for land transaction, real estate acquisition tax, and registration license tax

Table 1. Comparative table of projects related to post-earthquake community reconstruction<sup>1)</sup>

# 15 The Living Environment and Earthquake Disaster Countermeasures of the Future

## 15-1 Lifestyle and disaster

The current high-consumption society based on tertiary industry virtually imposes a duty of excessive consumption on its members.

It now seems that the social awareness of Japan has shifted to a new stage, as shown by the increased monitoring of electric power consumption and excessive housing; there seems to be a return to the appreciation of a more prudent, less consumption-oriented lifestyle.

### Livelihood philosophy on disaster

It is 72 years from the 1923 Great Kanto Earthquake to the 1995 Great Hanshin-Awaji Earthquake, and another 16 years to the 2011 Great East Japan Earthquake; in this period, Japan has experienced several different types of earthquakes, including one whose epicenter was directly below several urban areas, and a subduction-zone earthquake whose epicenter was off the Pacific coast. This section looks at how the Japanese have changed and examines how they as a society have faced such disasters during this period.

### From primary industry to tertiary industry

Looking at the industrial composition of Japan in 1920, primary industry accounted for 55% and secondary and tertiary industries were about 20% each. By 1995 primary industry had shrunk to just 6% and by 2011 it was to halve again to 4%. In this same period, secondary industry decreased from 34 to 25%, while tertiary industry increased from 60 to 70%. In the Taisho Era (1912-1926) the majority of Japanese were engaged in agriculture, forestry, or fisheries, whereas today 70% of workers are white-collar, and primary industry accounts for less than 2% of the gross domestic product of Japan, and its productivity has become very low (Figure 1).

This trend is also seen in Kobe as well as the three prefectures in the Tohoku region which suffered earthquakes. Today, however, the importance of monozukuri (the art of design and manufacturing) is being reevaluated.

### Doubts about a high-consumption society

During the period from the Great Kanto Earthquake to the Great East Japan Earthquake, the industrial structure of Japan shifted from the "stage of pre-industrial capitalism" based on agriculture, forestry, and fisheries directly to a "capitalist consumer society" based on tertiary industry such as commerce, distribution, information and services, passing rapidly through the "stage of industrial capitalism" based on the production of secondary industry. By the time of the Great Hanshin-Awaji Earthquake the average Japanese enjoyed one of the highest levels of income in the world, and the attitude to daily life shifted from "considering diligence and austerity as virtues" to a more leisure-oriented and waste-oriented approach in which "hobbies, relaxation, or a happy family life came to the fore."

However, after reaching a peak in 1996, by 2010 the average family income had dropped by 20%, while in many countries incomes had increased.

### What discretionary consumption means

The Japanese style of consumption has shifted from one based on the purchase of daily necessities to discretionary

consumption. This change means that if the Japanese were to restrain their discretionary consumption and return to the Taisho Era ethos of "considering diligence and austerity as virtues," the Japanese economy with its heavy dependence on tertiary industry would plunge into depression, the state would be bankrupted, in addition to a very real chance of a world recession. As Japanese consumer society is now selecting a more "prudent style of consumption," the time may have come when the industrial structure of Japan must make a shift.

### Aging of society, family disorganization, and single-person households

Since the end of World War II, the average height of the Japanese increased by more than 10 centimeters; the average life expectancy of Japanese women doubled, from 43 to 86.4 years, and Japan has become the world's top country for longevity.

The average number of family members in the Taisho Era was about 5, decreasing to less than 3 today (Figure 2). A woman delivered 4.7 babies on average in the Taisho Era, compared to 1.23 today. The separation of households has further advanced due to an increasing tendency to marry later, the popularization of higher education, increase in the divorce rate, etc., the rate of nuclear families has peaked, and single-person households now exceeds 20%. The lifetime non-marriage rate has increased, and Japan has entered into a "declining society" in which the number of deaths exceeds the number of births. In the past few years the average number of children born per woman has gradually increased due to the introduction of child allowance. Moreover, after the experience of the Great East Japan Earthquake, the fragile and precious nature of family ties have been reaffirmed.

### Excessive energy consumption and a surplus of houses

A positive side effect of the rolling blackouts caused by the nuclear accident was a change in attitude to nighttime, people living in cities who had become familiar with townscapes illuminated all night rediscovered the beauty of the night sky and darkness, and also started to question the existences of vending machines all over their cities.

The total amount of national garbage was 54.83 million tons in 2000, decreasing to 45.25 million tons by 2009 (Figure 3). However, 20 million tons of rubble from demolition, etc. was cleared after the Great Hanshin-Awaji Earthquake, and 25 million tons after the Great East Japan Earthquake (Figure 4).

The average floor area of newly constructed houses reached 120 m<sup>2</sup> in 2003 and exceeded that of European countries. Moreover, the existing housing stock is 53.89 million, more than the number of families in Japan, 47.26 million, giving some 6.59 million vacant dwellings (12.2% of the total number of houses), a number which is still increasing. Under these conditions of the increasing shrinking and separation of households, and the declining birthrate and an aging population, the number of vacant dwellings continue to increase, but even so annually, some 800,000 new dwellings, which have a larger total floor area than new builds in Europe, are built. To sustain this high consumer society, overinvestment (waste) in an enormous amount of housing construction is still continuing.

### Shift from a country dominated by the construction industry

In 1991, the construction expense per 1 km<sup>2</sup> of the land area of Japan was 21.7 billion yen, which was 3 times more than Germany, 6 times of France, and 36 times the United States. In the same year, construction expense per 1,000 of the population of Japan was 673 million yen, which was 2 times more than Germany and France, 3 times the United State, and 3.8 times the United Kingdom. This means that Japan, a country with small land, wasted the greatest amount of construction per capita in the world.

The amount of investment in construction in Japan around 1991 was 80 trillion yen, which has decreased to a half, 40 trillion yen, at present (Figure 5). Moreover, expenses for maintenance and the repair of existing buildings, etc. account for

more than 20% of the total amount of investment in construction, which clearly demonstrates that the structure of the construction industry is shifting from flow to stock. Japan has now reached a critical moment, and the question to be answered is just what kind of reconstruction vision for the Tohoku region can the shifted construction industry of Japan imagine?

(Tetsu Miki)

- Sources of figures
- 1) Labour Force Survey
- 2) National Institute of Population and Social Security Research, Comprehensive Survey of Living Conditions
- 3) Information provided by the Ministry of the Environment
- 4) Ministry of the Environment: Progress on treatment of debris from the Great East Japan Earthquake (in coastal municipalities of the three most affected prefectures)
- 5) Ministry of Land, Infrastructure, Transport and Tourism

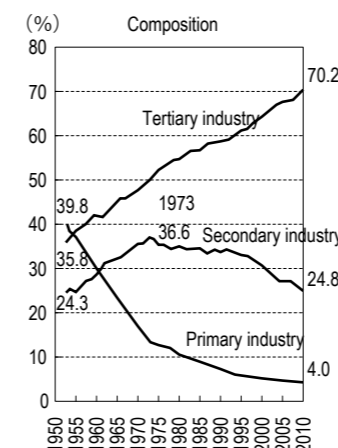

Figure 1. Industrial composition<sup>1)</sup>

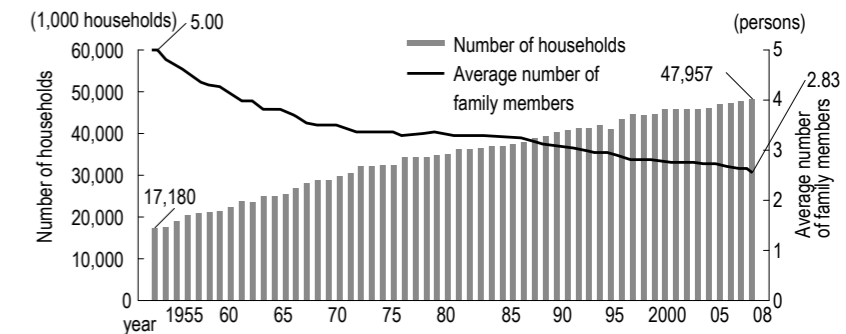

Figure 2. Increasing number of households and decreasing number of family members in Japan<sup>2)</sup>

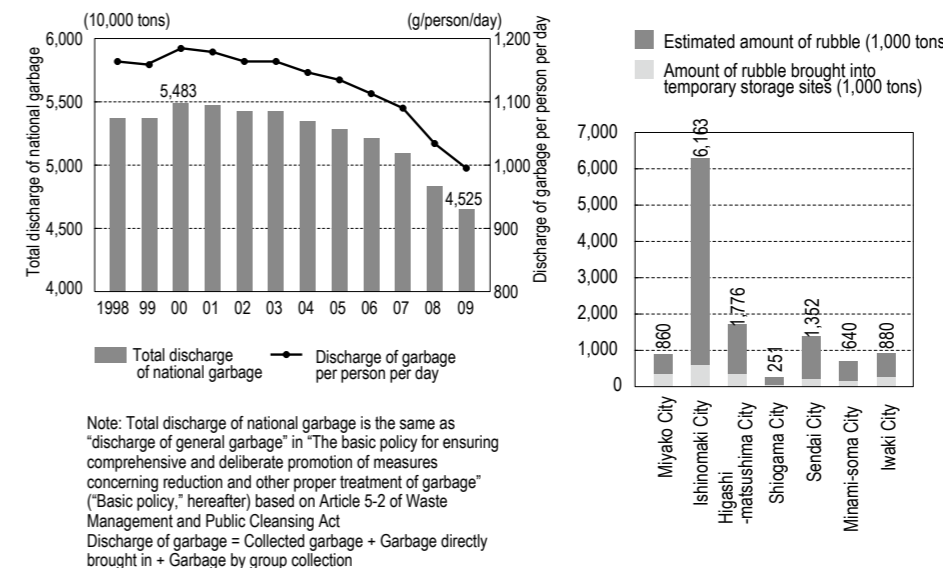

Figure 3. Transition of discharge of garbage<sup>3)</sup>

Figure 4. Amount of rubble in the areas affected by the Great East Japan Earthquake<sup>4)</sup>

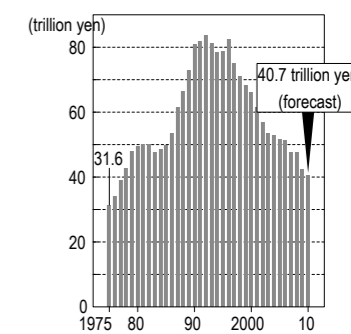

Figure 5. Transition of amount of investment in construction of Japan<sup>5)</sup>

## 15-2 An advanced information society and disaster countermeasures

The disaster countermeasures for information include: 1) Ensuring the means of communication, 2) Ensuring the means of safety confirmation, 3) Backup of electronic data, 4) Backup systems for information systems, 5) Enhancement of earthquake resistance performances of information systems, and 6) Conservation of printed information.

### Ensuring the means of communication

Some companies to ensure their means of communication need to consider the use of multiple means of communication such as land-line phones, mobile phones, satellite phones, faxes, PC e-mail, mobile e-mail, web, etc., and signing up with multiple communications companies or network providers, as well as the multiplexing of communication lines.

In addition, in-house power generators and batteries are often installed to respond to blackouts. However, it is assumed that any interruption to electric power and internet communication would be restored in about a week, and that congestion of land-line phones and mobile phones would be resolved in one or two weeks. There is little need for ordinary firms whose social and/or economic purpose is not overly important to invest heavily in these countermeasures.

### Ensuring the means of safety confirmation

Disaster Emergency Message Dial is intended for individual use. Firms above a certain size should set up their own safety confirmation systems. Considering that based on simple probability theory great earthquakes have a high likelihood of occurring on a holiday or at night, it may well be an obligation of employers to consider contracting with providers of safety confirmation services offering automatic notification. Recent safety confirmation services, sharing earthquake information with the Japan Meteorological Agency (Japan Weather Association), provide functions including automatic transmission of safety confirmation emails to officers and employees from provider system centers, as well as organizing reply emails and transmitting them to disaster control centers (or safety confirmation bases).

### Backup of electronic data

According to the guidelines issued by the Cabinet Office, "it is required not only to ensure the backup of necessary information and store it at a place free from the likelihood of damage from the same disaster, but also to build up a backup system, especially for any information system which supports important activities."

Backup data may be stored within a base (within the same building) such as a headquarters office, or within a different place (a storage place of tapes, a remote site connected with a network, etc.).

In the former case, once-a-week full backup and incremental (or differential) backup on other days are usually required, along with a sure validation of any restore and recovery operations prepared for disasters. When the base has adequate earthquake resistance and the server and data library are earthquake-resistant (or are seismically isolated with isolation plates), this method should be adopted first of all.

Backup tapes made at a base such as a headquarters may be stored in a remote warehouse by commissioning a safe-

ty-deposit company.

In the latter case, remote backups are made by connecting a designated backup server (or a server subject to backup) and a data backup system, installed in the data center of the network provider of data backup services. Therefore, backup data is stored in the data center of the provider. Or, for example, when a branch office in Osaka has been equipped with an equivalent level of information system to the headquarters office, the system is often utilized as a backup system.

### Backup system

A server facility requires a production environment (electric power source, air conditioning equipment, ventilation equipment, telecommunications infrastructure, wiring network, etc.) and a system (various hardware and software), and therefore it differs greatly from other facilities such as ordinary offices.

Methods of recovery include the three methods shown in Table 1. Here, the case of establishing a server facility at a different place (a place free from experiencing damage from the same disaster) from the existing server facility such as a headquarters office or information center is assumed.

In the case of a warm site, the issue of ensuring "staff" who establish software, input data, run a trial, and operate the system should be solved.

It is also true in the case of a cold site. Assuming traffic controls and railroads recovery conditions, "being able to ensure staff at a place remote from the present site" is required for both warm and cold sites.

### Enhancement of earthquake resistant performance of information systems

The countermeasures to enhance earthquake resistant performance include the seismic fixation of servers and data libraries, ensuring excess cable length, the adopting of flexible joints at pipe connections, the installation of seismically isolated floors (or isolation plates), and the duplication of equipment including electric power sources and lines.

Precision instruments such as servers are prone to be affected by any variation of electric power and/or voltage, and therefore if the voltage suddenly decreases during a blackout, electronic data within computers is likely to suffer damage (loss of data, damage of files, etc.). Therefore, UPS (uninterruptible power supply) should be considered for installation in the system; when a blackout occurs, UPS simultaneously supplies electric power stored in an embedded battery to the system and transmits a shutdown signal, to ensure enough time for the system to be safely shut down. In the case of firms whose social and/or economic mission is great, installations of in-house power generator (for emergency and regular use) should be considered. The facilities where electric power must not be interrupted such as key public administration facilities, disaster base hospitals and computer centers of financial institutions sometimes can supply electric power using in-house power generators for more than 3 days. However, in the case of the headquarter buildings of big companies whose social and/or economic mission is not very great, their in-house power generators often can supply electric power for just a few hours (3 to 8 hours). Attention should be given to the fact that the benefits of an in-house power generator are not in simply supplying electric power, but in providing conditions for the emergency evacuation and rescue of disaster victims,

inspection of damage situations, and ensuring the functions of minimum emergency broadcasting, lighting, ventilation, and discharge of water at the time of fires.

### Conservation of printed information

First of all, those documents that require backup should be selected. The Cabinet Office guidelines recommend that "any vitally important documents to the survival of a company and those that cannot be substituted (called vital records) should have backups made," and also indicate that "there are immediately needed documents at the time of disaster including drawings, layout plans, quality control documents, etc. and not-immediately needed documents including documents for the maintenance of corporate governance/internal control, compliance with laws, and ensuring accountability, as well as documents for the establishment of rights and obligations, and ensuring claims and debts, etc."

The principle of storage is to store any "actual things" in a safe place. A top executive whom the author supported to prepare a BCP (business continuity plan) is storing the actual things in a safe-deposit box of a neighboring bank with high earthquake resistance. The vital records of the firm have been listed and the documents have been digitized into electronic

format and are being managed by computers in the headquarters office. Moreover, photocopies (printed documents) of the actual things are stored in a fire-resistant safe. Triple measures like this work toward establishing fail-safe systems.

Computerized document management has been adopted by many firms because it is inexpensive and easy-to-use. When such measures are taken, storing actual things at a remote place such as a branch office is worth considering.

Naturally, not only conservation of electronic data but also actual things (originals) such as contract documents and copies of registrations are of the utmost importance, which was clearly demonstrated by the disorder following the Great East Japan Earthquake. Although only printed documents have been discussed here, any items incidental to printed documents such as the corporation seal, the company's seal for bank accounts, various other seals, etc. should also be safely conserved. (Yukio Osawa)

- References  
 (1)Written and edited by Yukio Osawa, Jishin risuku taisaku tatemono no taishin kaishū jokyakuho (Countermeasures against earthquake risks: Methods of seismic retrofit and removal of buildings), Chuokeizai-sha, 2009  
 (2)Cabinet Office, Business Continuity Guidelines - 1st edition, 2005

	Hot site	Warm site	Cold site
Method	A set of information system including production environment and system itself (hardware and software) have been installed, and the latest data has been input. Staffs have been deployed, and the system is sometimes operated in parallel with existing systems.	Production environment and main hardware and software of the system have been prepared (stored). However, data has not been input, or software has not been installed. To begin operation, software should be installed, data should be input, and the system should be tested.	Only production environment has been prepared. Hardware and software have to be brought in after the occurrence of disaster, and have to be set, installed, and tested.
Characteristics	The system is recoverable in a few minutes to half a day after the occurrence of disaster. The system is usually adopted in those facilities where the systems must experience no interruption such as banks and securities companies.	The system requires the works mentioned above to be carried out. The system is recoverable relatively quickly, because there is no need to procure hardware or software after the occurrence of the disaster.	The system requires the works mentioned above to be carried out. The system requires the longest period to recover, because hardware and software have to be procured after the occurrence of the disaster.

Table 1. Methods of backup system

### 15-3 An aging society and disaster countermeasures

**Urban housing, including medium- and high-rise housing, should provide easier evacuation, interact with neighborhood communities, and expand the exchange and support of mutual aid between the residents, by improving accessibility to the ground and spaces for the community. Moreover, day-to-day social exchange between young and elderly people should be promoted.**

#### Injury situation of the elderly

According to an announcement by the National Police Agency, as of May 2012, the Great East Japan Earthquake caused in excess of 15,000 deaths and 3,000 missing. According to the April 2011 figures, in the three prefectures of the Tohoku region 22 to 27% of the population was 65 years old or older, but the percentage of the elderly missing or dead due to the earthquake and tsunami accounted for more than twice that figure at 55%. Primary causes of death were drowning and multiple injuries due to being swept away with rubble. The Great Hanshin-Awaji Earthquake caused 6,000 plus deaths and persons of 65 years old or older accounted for 49.6%, many of whom were crushed to death by house collapse. These sobering figures raise the issue of lifesaving measures against tsunami disasters including the location of housing and community developments. At the time of earthquakes, not only the safety of houses but also quick safety confirmation of residents should become key points for rescue operations.

#### Architectural measures responding to an aging society

Architectural measures responding to an aging society should be based on safety improvements and creation of spaces which activate communities.

##### (1)Day-to-day safety

Barrier free measures, including eliminating steps, attaching balustrades, provision of slopes and wheelchair accessibility, and the new installation of elevators, not only improve the residential environment and help support the elderly to be self-reliant, but also should be effective for mitigating injury to the elderly at the time of an emergency such as an earthquake.

##### (2)Improving ground accessibility

Ensuring living spaces with high ground accessibility in medium- and high-rise housing provides easier evacuation for the elderly residents as well as supporting rescue operations from outside the area. To design balconies and hallways, which are familiar exterior spaces, as comfortable spaces is also effective for increasing social exchange between the residents. Moreover, it is desirable to design common spaces such as hallways as wide open spaces to counterbalance the closed spaces of apartments.

##### (3)Enhancement of spaces for communities

Condominiums and detached houses should be maintained and improved by the residents themselves. These buildings require the maintenance of both the building and equipment (including deterioration prevention, improvements of durability and earthquake resistance) as well as managerial administrative operations (Figure 1). The provision of such appropriate spaces for the activities described above will greatly affect the development of community activities. A condominium

should provide a gathering space commensurate with its size. Although there are many condominiums without any gathering space, entrance halls or management offices may well be utilized for gatherings. In residential areas of detached houses, streets may serve as pedestrian spaces.

#### Aging society and planning of residential districts

##### (1)Residential districts for multiple generations

A stable and mature residential district contains a healthy balance of young and older generations. In practice, in a newly constructed condominium or housing complex, the younger generation will make up a greater portion of the residents. Supplying a great number of uniform-sized dwellings in a short period must lead to an aging community due to the lack of residents moving in and out. A community that contains a proper balance of young and older generations not only is a thriving community but also provides and supports mutual aid between the residents at the time of an emergency or disaster. The Takashimadaira housing complex in Tokyo and Nishi-konakadai housing complex in Chiba are attracting attention for their experiments in cooperation with neighboring universities (Figures 2 and 3). The initiative attempts to revitalize the housing complex, and includes offering inexpensive dwellings in the housing complex, where there are a lot of vacant units, to students, as well as giving them the opportunity to participate in community activities. Students can live near the university with a lower rent, and the housing complex is revitalized by the participation of the younger generation.

##### (2)Connections between generations through living next to each other and living in proximity

In cities it is quite common that an aged household lives separately from their child's household. As the words of the saying "close enough for the soup not to get cold" show, distance between the two houses does matter and can easily become an issue. As a lifestyle choice living in proximity provides more scope than living in a two-family house or living next to each other. Planning of residential districts should include houses with a variety of sizes, prices, and rents in a district or along the railroad line.

#### Disaster control activities and manuals (management and resident associations activity, list of residents, disaster control manuals, and disaster drills)

Disaster control activities in communities play an important role providing safety confirmation, rescue, and support for vulnerable groups. Systems that enable self-help and mutual assistance should be encouraged and built up in addition to the provision of public support. The elderly and people with disabilities are known by preparing lists of such residents. Disaster control manuals are being prepared by prefecture, city, ward, district, and condominium. Just copying a manual from another district will not be sufficient to reflect the characteristics of the home residential district; residents can refer to other examples, but must ultimately personalize them for their district. Disaster drills are also an important component; and with most of the younger generation away at work during the day, consideration must be given to how the elderly and housewives should respond to a disaster in the daytime.

(Kazuhiro Abe)

□Source of figures

1) Website of Chuo Ward, <http://www.city.chuo.lg.jp/kurasi/saigai/bosai/bousai/kosomove/files/hyousi.pdf>



Figure 1. A brochure of disaster countermeasures for high-rise housing (Chuo Ward)<sup>1)</sup>



(a) Calligraphy class 1



(b) Calligraphy class 2



(c) Entrance of community cafe



(d) Residential buildings in Takashimadaira housing complex

Figure 2. Activities in Takashimadaira housing complex



Figure 3. Disaster drill for residents of a condominium (Granfore Totsuka Hill Breeze, photo: Takashi Mori)

## Appendix

Useful websites and links given below concern quakes of the ground and the assumption of damage at the occurrence of earthquakes.

### 1. Forecasting future earthquakes (National Research Institute for Earth Science and Disaster Prevention, Japan Seismic Hazard Information Station)

<http://www.j-shis.bosai.go.jp/map/> (Figure 1)

- This is the website of the Japan Seismic Hazard Information Station (J-SHIS) which provides facilities to search Seismic Hazard Maps prepared by the Headquarters for Earthquake Research Promotion, Ministry of Education, Culture, Sports, Science and Technology.

- The color coded maps show by earthquake categories the likelihood of earthquakes with intensities of 5 lower to 6 upper within the next 30 and 50 years.

- Earthquake categories:

Category I: Among subduction-zone earthquakes, those earthquakes whose focal fault can be identified

Category II: Among subduction-zone earthquakes, those earthquakes whose focal fault is difficult to identify

Category III: Shallow earthquakes in ocean and continental areas such as at active faults

### 2. Earthquakes that occur in Japan (Cabinet Office)

[http://www.bousai.go.jp/jishin/chubou/taisaku\\_gaiyou/pdf/hassei-jishin.pdf](http://www.bousai.go.jp/jishin/chubou/taisaku_gaiyou/pdf/hassei-jishin.pdf) (Figure 2)

- Earthquake distribution of the world, earthquake distribution of Japan, plates around Japan and mechanism of earthquake occurrence, earthquake types that occur around Japan, magnitude and seismic intensity, major earthquake hazards of Japan, and the impending likelihood of an earthquake whose epicenter is directly below Tokyo are explained.

### 3. Website of disaster management information by the Cabinet Office

<http://www.bousai.go.jp/>

- The Cabinet Office has collected information on different kinds of disasters in Japan. Extreme Disaster Management Headquarters and Central Disaster Management Council are established in the Cabinet Office.

### 4. Investigative Commission on the Giant Earthquake Model of Nankai Trough (Cabinet Office)

[http://www.bousai.go.jp/jishin/chubou/nankai\\_trough/15/index.html](http://www.bousai.go.jp/jishin/chubou/nankai_trough/15/index.html) (Figure 3)

- Information on simulations of earthquakes and tsunamis in the Nankai trough are presented in the website.

### 5. Technical data for the preparation of Earthquake Disaster Hazard Maps (Cabinet Office)

<http://www.bousai.go.jp/oshirase/h17/050513siryou.pdf>

- A technical manual for the preparation of Earthquake Disaster Hazard Maps by public administrations is presented in the website.

### 6. Explanation of seismic intensity scales (Japan Meteorological Agency)

<http://www.jma.go.jp/jma/kishou/now/shindo/shindokai.html> (Figure 4)

- Seismic intensities and quaking situations (outlines) are shown in the table.

### 7. Map of building collapse risk rankings (Tokyo Metropolitan Government)

#### 1) Risk of building collapse

[http://www.toshiseibi.metro.tokyo.jp/bosai/chousa\\_6/download/houkouku\\_2.pdf](http://www.toshiseibi.metro.tokyo.jp/bosai/chousa_6/download/houkouku_2.pdf) (Figure 5)

- It shows a table of the top 100 districts and towns of Tokyo ranked in terms of building collapse risk, as well as a map of districts and towns presented in



Figure 1

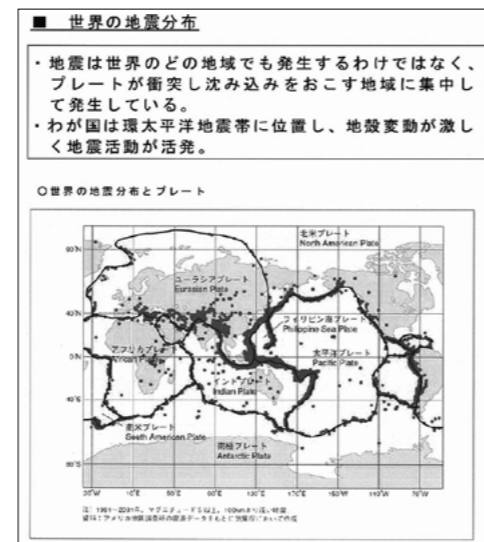

Figure 2



Figure 3



Figure 4

different colors according to their rank from blue for 1 to red for 5.

#### 2) Risk of fire spread

[http://www.toshiseibi.metro.tokyo.jp/bosai/chousa\\_6/download/houkouku\\_3.pdf](http://www.toshiseibi.metro.tokyo.jp/bosai/chousa_6/download/houkouku_3.pdf)

- It shows a table of the top 100 districts and towns of Tokyo ranked in terms of fire spread risk, as well as a map of districts and towns presented in different colors according to their rank from blue for 1 to red for 5.

#### 3) Comprehensive risk

[http://www.toshiseibi.metro.tokyo.jp/bosai/chousa\\_6/download/houkouku\\_4.pdf](http://www.toshiseibi.metro.tokyo.jp/bosai/chousa_6/download/houkouku_4.pdf)

- Rankings have been determined by adding the rank of the building collapse risk and the rank of fire spread risk of the districts and towns of Tokyo.

- It shows a table of the top 100 districts and towns of Tokyo ranked in terms of comprehensive risk, as well as a map of districts and towns presented in different colors according to their ranking from blue for 1 to red for 5.

### 8. Liquefaction hazard map of the Tokyo metropolitan area (Tokyo Metropolitan Government)

<http://doboku.metro.tokyo.jp/start/03-jyouhou/ekijyouka/> (Figure 6)

- It is a website of map forecasts prepared by the Civil Engineering Center, Tokyo Metropolitan Government and is used for searching liquefaction hazard maps.

- It is a liquefaction hazard map classifying the whole area into three categories: area of probable liquefaction, area of possible liquefaction, and area of unlikely liquefaction; the degrees of risk are given in 8 colors from blue to red.

### 9. Liquefaction hazard map of Chiba prefecture (Chiba prefecture)

<http://www.pref.chiba.lg.jp/bosai/jishin/higaichousa/souteijishin/ekijyouka.html>

- Liquefaction hazard map of Chiba prefecture is presented in the website. There are three kinds of maps according to different kinds of focus.

### 10. TITECH EQRisk Map View – Earthquake risk map of your town and home (Midorikawa Laboratory, Tokyo Institute of Technology)

<http://riskmap.enveng.titech.ac.jp/> (Figure 7)

- The website presents an earthquake risk map of the Tokyo ward area and eastern Kanagawa prefecture that answers the question “what will happen where I live when a great earthquake occurs?”

- It is assumed that the magnitude of the earthquake is M7.3 and the focus is northern Tokyo Bay.

- A map of the place with seismic intensities and the assumed degree of damage are shown by inputting the following data: time of completion of the building: before or after 1981; the building type: wooden, low-rise reinforced concrete, or medium- or high-rise reinforced concrete building; and the building address.

### 11. Earthquake Disaster Hazard Map of Setagaya Ward (Setagaya Ward)

#### 1) Seismic intensity map

<http://www.bousai.go.jp/oshirase/h17/050513pdf/2-1.pdf>

- This map shows the seismic intensity of the areas within Setagaya Ward with 7 grades, from 6 lower to 7 upper, in different colors.

#### 2) Area risk map

<http://www.bousai.go.jp/oshirase/h17/050513pdf/2-2.pdf> (Figure 8)

- This map shows the earthquake risk of areas within Setagaya Ward with 5 grades, from Risk 1 to Risk 5, as well as the percentage of buildings that will totally collapse in each area.

- The information shown above is as of April, 2012. The URL and the name of organizations may be subject to change without prior notice.

- Thanks to Minoru Karuishi (Japan Aseismic Safety Organization) for the preparation of the appendix.

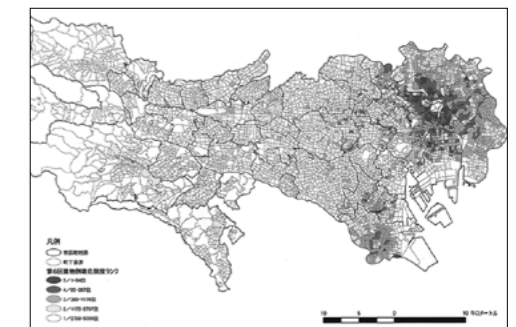

Figure 5



Figure 6



Figure 7



Figure 8

## Postscript

**Kazuo Adachi**

Editorial Committee of New Edition (Nihon Sekkei, Commissioner of Japan Aseismic Safety Organization)

### **Between the 1995 Great Hanshin-Awaji Earthquake and the Great East Japan Earthquake**

The first edition of this book was published after the 1995 Great Hanshin-Awaji Earthquake, and this book is a new updated edition issued in response to the 2011 Great East Japan Earthquake. During these 16 years, our knowledge of earthquakes has greatly changed and expanded; in addition the tremendous impact of tsunami and their devastation, which had previously been left out of consideration by architects has now been acknowledged and incorporated into architectural practice. Therefore, a far greater part of this book had to be rewritten than had been originally expected. As a result, however, many new findings, perspectives, and recommendations could be added while still staying true to the original holistic view on earthquake disasters of the first edition. I would now like to give my expectations for the use of this book in the form of a postscript.

### **To mitigate the damage of the next earthquake**

The Tohoku Earthquake with a magnitude of 9, heralded an active period for the crust of Japan; the probability of great Tokai, Tonankai, and Nankai earthquakes as well as other great earthquakes whose epicenters are directly below Tokyo has rapidly increased. I very much hope that this book contributes to the mitigation of coming earthquake and tsunami disasters. It is assumed that if even one great earthquake occurred, the number of dead or missing would reach up to 300,000, far more than the 20,000 fatalities of the Great East Japan Earthquake. Moreover, the key functions of government, the economy, and industry would suffer tremendous damage. It is the duty of architects to reduce the assumed damage as much as possible. The order of priority should be the preservation of life, safety, function maintenance, and then business continuity. I hope that the readers of this book understand the mechanisms of earthquakes and tsunamis, and gain insights into three key areas: the designing of buildings that can resist these disasters; the seismic strengthening of buildings; and the taking of countermeasures against tsunamis.

### **Bridging the gap between experts and citizens**

The Great Hanshin-Awaji Earthquake exposed a great gap in the perceptions and expectations of architectural experts and citizens; in the following years the experts have made efforts to promote greater awareness and educate citizens in their expectation of what is possible and reasonable. However, there is still a gap concerning the perception of “buildings built in accordance with the new earthquake resistant standards that resisted the Great Hanshin-Awaji Earthquake and the Great East Japan Earthquake.” To an engineer, a surviving building frame is a positive testament to the success of the engineering; to a resident it is a bleak reminder of a disaster. So even though many serviceable building frames remained standing in the affected areas, most of them were demolished

within a year. The surviving building frames were not reused; communities were lost, large areas of ground sank and became submerged areas, and the frames of buildings where people had died were not reused but were demolished. Moreover, many non-structural walls of condominiums suffered damage and the doors would not open. Many party walls made with boards broke and fire compartments were ruined. Strength alone cannot ensure the role of a building; only after a building can maintain the functions needed to serve the community and their livelihoods, can a building be accepted by the citizens.

### **For a designer of buildings to become an architect**

This book aims to provide a young designer of buildings with a broad (if shallow) knowledge about many fields including earthquakes, tsunamis, earthquake resistant construction, retention of equipment functions, and disaster prevention community development. As a supervisor of architectural design, a designer of buildings must respond to the questions and requests of the clients. Like the solving of conflict between disaster prevention functions and ordinary functions, well-balanced architecture cannot be realized without ensuring the harmony and integration of the architecture, structure, and equipment in a good earthquake-resistant design. This is the role of the designer. It is said that architectural designers in Japan are the most capable in the world, for they have knowledge of both structure and equipment. I really hope they gain useful knowledge about earthquake resistance from this book, and the confidence to act as an architect who can supervise the whole architecture while resisting the specialization and segmentation of the different fields and practices.

### **For a community architect to gain the trust of the community**

Summarizing the above, I hope that “architects use this book for holistically grasping architecture, filling in the gaps with citizens, and mitigating the damage from the next earthquakes and tsunamis.”

The Japan Institute of Architects (JIA) will become a public-interest corporation in 2013. The basis for JIA's activities are area clubs spread over Japan. NPO Japan Aseismic Safety Organization (JASO) is cooperating with the project to seismically strengthen buildings alongside emergency transportation routes implemented by the Tokyo Metropolitan Government. Furthermore, it has initiated a series of popularization activities for projects in the wards of Tokyo, including the dispatch of seismic advisors, and the provision of simple diagnosis, detailed diagnosis, and seismic retrofit. To ensure their acceptance JIA and JASO have been gaining the trust of communities and condominium homeowner associations, and have started to play the role of community architect. I guess most readers of this book are not members of JIA or JASO. However, I hope by starting with this book, they add to their study and experience of countermeasures against earthquakes and tsunamis. This book will have fulfilled its purpose and become a very useful little textbook when in cooperation with the citizens of their communities they prepare against the disasters that are forecast to occur in the near future.



EARTHQUAKE-RESISTANT BUILDING DESIGN FOR ARCHITECTS  
Revised edition

First published on April 10, 1997  
Revised edition, first published on September 10, 2012

Proof mark is omitted through agreement with the copyright holder.

Member of The Natural Science Publishers' Association of Japan  
Member of The Engineering Publishers' Association of Japan

Edited by the Japan Institute of Architects and Japan Aseismic Safety  
Organization  
Publisher: Takeshi Goto  
Publishing company: SHOKOKUSHA Publishing Co., Ltd.  
8-21, Tomihisa-cho, Shinjuku-ku, Tokyo 162-0067  
Phone: 03-3359-3231 (main)  
Transfer account: 00160-2-173401

Printed in Japan  
Copyright © The Japan Institute of Architects and Japan Aseismic  
Safety Organization, 2012

Printed by Shinkosha Printing Co.  
Bound by Brocade

ISBN 978-4-395-02301-1 C3052  
<http://www.shokokusha.co.jp>

All rights reserved. No part of this publication may be duplicated  
(including by photocopying), reproduced, or recorded by any means  
(including magnetic and optical recording media), without permission of  
the publisher. Requests for permission should be addressed to the  
publisher.

To whom this report may interest,

There are many earth quake prone countries in this world, not only Japan

Therefore, at various occasions we were requested to explain our efforts and initiatives for reducing the risk of future earth quakes.

After the Great Hanshin Earthquake, we had studied various methods to reduce the damages to ensure inhabitants lives, through collaborations of architects, structural engineers, building mechanical engineers and various specialists. Those considerations were realized in the book “Taishinkyohon” by the Japan Institute of Architects. The book was also revised after the Great East Japan Earthquake experiences.

Owing to the language barriers, we are not able to explain easily our initiatives to outsiders. Therefore, we had tried to publish it in an English edition. Nevertheless through economic difficulties, English editions had not been translated until now. In 2014, NPO called Japan Aseismic Safety Organization (JASO), decided to donate for the English translation, and furthermore their members donated for editing in English to form this report as well.

Since original Japanese book was published by publisher Shokokusha in Tokyo who still has the right to publish this book, we finally agreed that we would not sell commercially, but disperse only as a delivered free booklet with internet downloads. Therefore, anyone who likes to study is able to download from the HP of JASO who is holding their rights for the English Translations. <http://www.jaso.jp/>

Thank You,  
March 14, 2015

The Committee for the English translation and publishing,  
HISAICHI SATO, JASO  
JUNICHI NAKATA, JIA JASO  
KAZUO ADACHI, JIA JASO  
NORIYUKI OKABE JIA JASO  
TORU NAKADA , JIA JASO